



**KZ1000**  
**KZ1100**



# **Motorcycle** **Service Manual**

## Quick Reference Guide

To use, bend the manual back and match the desired chapter below against the black spot showing at the edge of these pages.



**General Information** **1**

**Scheduled Maintenance** **2**

**Non-scheduled Maintenance** **Engine** **3**

**Chassis** **4**

**Electrical** **5**

**Disassembly** **Engine** **6**

**Chassis** **7**

**Appendix** **8**

**Supplement - KZ1100-B1** **9**

**Supplement - 1982 Model** **10**

**Supplement - 1983 Model** **11**

**Index** **12**

# Motorcycle Service Manual

All information contained in this manual is based on the latest product information available at the time of publication. The right is reserved to make changes at any time without prior notice and without incurring any liability. See your Motorcycles for product improvements incorporated after the date of publication. Kawasaki Heavy Industries, Ltd. Consumer Products & Components Group, KHI.

Kawasaki Heavy Industries, Ltd. accepts no liability for any inaccuracies or omissions. Every possible care has been taken to make this manual accurate and complete as possible. All subject to change without notice to every country.

# General Information

## Table of Contents

(13) Liquid Gasket, Non-permanent Locking Agent  
 Follow manufacturer's directions for cleaning and grinding surfaces before gasketing. Apply the application section as recommended to the gasketing surface. Use a suitable primer and detailed gasketing instructions. Never use a gasketing compound or gasketing tape. Gasketing compound and gasketing tape are not recommended for use on the cylinder head or other mating surfaces. Gasketing compound and gasketing tape are not recommended for use on the cylinder head or other mating surfaces. Gasketing compound and gasketing tape are not recommended for use on the cylinder head or other mating surfaces.

(14) Ball Bearing, Oil Seal, Grease  
 When installing a ball bearing, the bearing race which is affected by the ball bearing should be held in place by a suitable driver. This prevents stress on balls and races, and prevents the bearing from being damaged. When installing a ball bearing, the bearing race which is affected by the ball bearing should be held in place by a suitable driver. This prevents stress on balls and races, and prevents the bearing from being damaged.

BEFORE SERVICING ..... 1-2  
 MODEL IDENTIFICATION ..... 1-3  
 SPECIFICATIONS ..... 1-5  
 TORQUE AND LOCKING AGENT ..... 1-9  
 SPECIAL TOOLS ..... 1-13  
 SERVICE DATA ..... 1-18  
 WIRING DIAGRAMS ..... 1-25

(6) Lubricant  
 Don't use just any oil or grease. Some oils and greases in particular should be used only in certain applications and may be harmful if used in an application for which they are not intended.

(7) Battery Ground  
 Before performing any disassembly operations on the motorcycle, remove the ground (-) lead from the battery to prevent the possibility of accidentally turning the engine over while partially disassembled.

(8) Engine Rotation  
 When turning the crankshaft by hand, always turn in the direction of normal rotation, which is clockwise, viewed from the right side of the engine. This is the proper adjustment.

(9) Lubrication  
 Engine valves operate at its maximum while the engine is running. Lubrication is more important than ever. Use the proper lubricant (oil or grease) (whichever is more suitable) and apply it to the proper parts. Use the proper lubricant (oil or grease) (whichever is more suitable) and apply it to the proper parts. Use the proper lubricant (oil or grease) (whichever is more suitable) and apply it to the proper parts.

(10) Press  
 A part which is being pressed into place should be held in place by a suitable driver. This prevents the part from being damaged.

(11) Oil Seal, Grease  
 Repair any damaged oil seals. When installing a new oil seal, use a suitable driver. This prevents the oil seal from being damaged.

(12) Gasket, O-ring  
 When in doubt as to the condition of a gasket or O-ring, replace it with a new one. The mating surfaces around the gasket should be free of foreign matter and perfectly smooth to avoid oil or compression leaks.

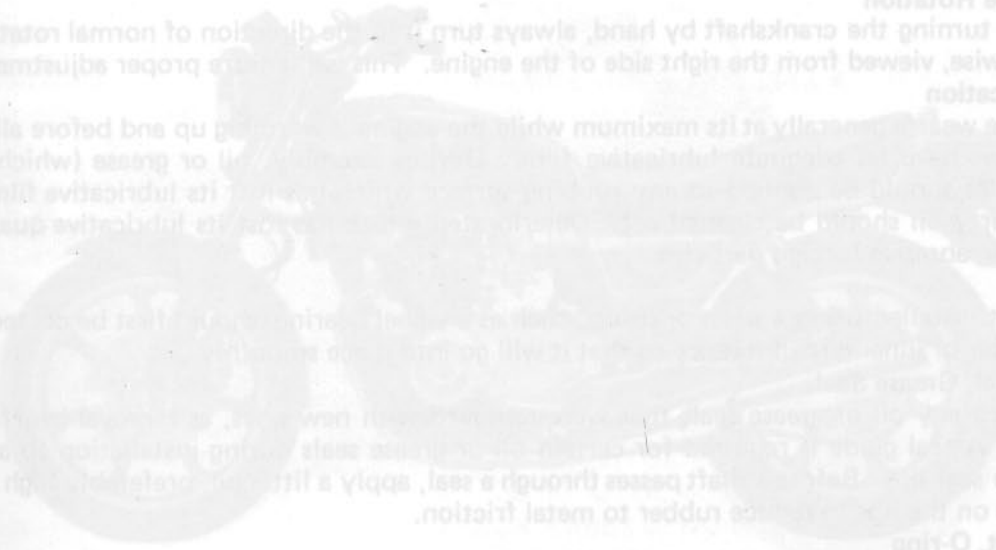

---

**BEFORE SERVICING**

---

Before starting to service a motorcycle, careful reading of the applicable section is recommended to eliminate unnecessary work. Photographs, diagrams, notes, cautions, warnings, and detailed descriptions have been included wherever necessary. Nevertheless, even a detail account has limitations, a certain amount of basic knowledge is also required for successful work.

**Especially note the following:**

- (1) Edges**

Watch for sharp edges, especially during major engine disassembly and assembly. Protect your hands with gloves or a piece of thick cloth when lifting the engine or turning it over.
- (2) Dirt**

Before removal and disassembly, clean the motorcycle. Any dirt entering the engine, carburetor or other parts will work as an abrasive and shorten the life of the motorcycle. For the same reason, before installing a new part, clean off any dust or metal fillings.
- (3) Tightening Sequence**

Where there is a tightening sequence indication in this Service Manual: the bolts, nuts, or screws must be tightened in the order and method indicated. When installing a part with several bolts, nuts, or screws; they should all be started in their holes and tightened to a snug fit. Then tighten them evenly, according to the tightening sequence, to the specified torque. This is to avoid distortion of the part and/or causing gas or oil leakage. Conversely when loosening the bolts, nuts, or screws; loosen all of them about a quarter of turn and then remove them.
- (4) Torque**

The torque values given in this Service Manual should always be adhered to. Either too little or too much torque may lead to serious damage. Use a good quality, reliable torque wrench.
- (5) Force**

Common sense should dictate how much force is necessary in assembly and disassembly. If a part seems especially difficult to remove or install, stop and examine what may be causing the problem. Whenever tapping is necessary, tap lightly using a wooden or plastic-faced mallet. Use an impact driver for screws (particularly for the removal of screws held by a locking agent) in order to avoid damaging the screw heads.
- (6) Lubricant**

Don't use just any oil or grease. Some oils and greases in particular should be used only in certain applications and may be harmful if used in an application for which they are not intended.
- (7) Battery Ground**

Before performing any disassembly operations on the motorcycle, remove the ground (—) lead from the battery to prevent the possibility of accidentally turning the engine over while partially disassembled.
- (8) Engine Rotation**

When turning the crankshaft by hand, always turn it in the direction of normal rotation; which is clockwise, viewed from the right side of the engine. This will ensure proper adjustments.
- (9) Lubrication**

Engine wear is generally at its maximum while the engine is warming up and before all the rubbing surfaces have an adequate lubricative film. During assembly, oil or grease (whichever is more suitable) should be applied to any rubbing surface which has lost its lubricative film. Old grease and dirty oil should be cleaned off. Deteriorated grease has lost its lubricative quality and may contain abrasive foreign particles.
- (10) Press**

A part installed using a press or driver, such as a wheel bearing, should first be coated with oil on its outer or inner circumference so that it will go into place smoothly.
- (11) Oil Seal, Grease Seal**

Replace any oil or grease seals that were removed with new ones, as removal generally damages seals. A seal guide is required for certain oil or grease seals during installation to avoid damage to the seal lips. Before a shaft passes through a seal, apply a little oil, preferably high temperature grease on the lips to reduce rubber to metal friction.
- (12) Gasket, O-ring**

When in doubt as to the condition of a gasket or O-ring, replace it with a new one. The mating surfaces around the gasket should be free of foreign matter and perfectly smooth to avoid oil or compression leaks.

**(13) Liquid Gasket, Non-permanent Locking Agent**

Follow manufacturer's directions for cleaning and preparing surfaces where these compounds will be used. Apply sparingly. Excessive amounts may block engine oil passages and cause serious damage. An example of a non-permanent locking agent commonly available in North America is Loctite Lock'n Seal (Blue).

**(14) Ball Bearing, Oil Seal, Grease Seal Installation**

When installing a ball bearing, the bearing race which is affected by friction should be pushed by a suitable driver. This prevents severe stress on the balls and races, and prevents races and balls from being dented. Press a ball bearing until it stops at the stop in the hole or on the shaft. Seals should be pressed into place using a suitable driver, which contacts evenly with the side of the seal until the face of the seal is even with the end of the hole.

**(15) Circlip, Retaining Ring**

Replace any circlips and retaining rings that were removed with new ones, as removal weakens and deforms them. When installing circlips and retaining rings, take care to compress or expand them only enough to install them and no more.

**(16) High Flash-Point Solvent**

A high flash-point solvent is recommended to reduce fire danger. A commercial solvent commonly available in North America is Stoddard solvent (generic name). Always follow manufacturer and container directions regarding the use of any solvent.

**(17) Molybdenum Disulfide (MoS<sub>2</sub>) Grease**

This manual makes reference to molybdenum disulfide grease in the assembly of certain engine and chassis parts. Always check manufacturer recommendations before using such special lubricants.

**(18) Electrical Leads**

All the electrical leads are either single-color or two-color and, with only a few exceptions, must be connected to leads of the same color. On any of the two-color leads there is a greater amount of one color and a lesser amount of a second color, so a two-color lead is identified by first the primary color and then the secondary color. For example, a yellow wire with thin red stripes is referred to as a "yellow/red" lead; it would be a "red/yellow" lead if the colors were reversed to make red the main color.

**MODEL IDENTIFICATION****KZ1000-J:**

Open  
Close  
Duration  
Exhaust  
Open  
Close  
Duration

102HP @8,500 rpm, (U) 97HP @8,500 rpm  
9.3 kg-m @7,000 rpm, (U) 8.8 kg-m @7,500 rpm

35° BTDC  
65° ABDC  
280°  
68° B8DC  
32° ATDC  
280°

Carburetion system

Cylinder numbering method

Firing order

Lubrication system

Engine oil

Grade

Viscosity

Capacity

Starting system

Ignition system

Timing advance

Ignition timing

Spark plugs

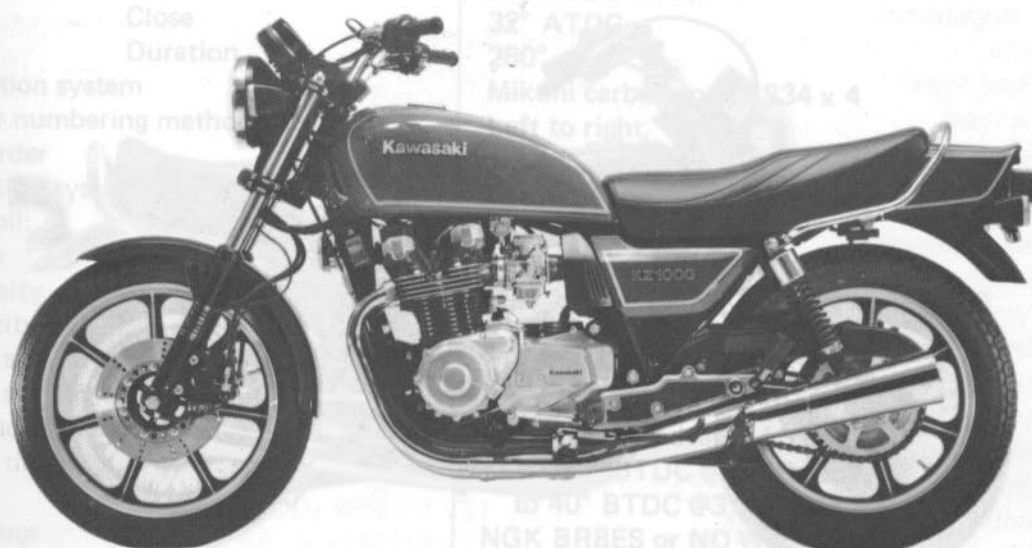

1040° BTDC @ 3  
NGK BR8ES or ND W  
(U) NGK BR8ES or ND W2

(U): US model (G): West German, Swiss, and Swedish models

Specifications subject to change without notice, and may not apply to every country.

(Continued on next page.)

KZ1000-K:



KZ1000-M:



(13) Liquid Gasket, Non-permanent Locking Agent  
 Follow manufacturer's directions for cleaning and preparing surfaces where these compounds will be used. Apply sparingly. Excessive amounts may block engine oil passages and cause serious damage. An example of a non-permanent locking agent commonly available in North America is Loctite Lock N Seal (Blue).  
 (14) Ball Bearing, Oil Seal, Grease Seal Installation  
 When installing a ball bearing, the bearing race which is affected by friction should be greased by a suitable driver. This prevents severe stress on the balls and races, and prevents loss and judder from being caused. First a ball bearing should be greased evenly with the side of the seal until the face of the seal is even with the end of the ball.

- (7) Fuel System
- (8) Engine Rotation
- (9) Lubrication
- (10) Press
- (11) Oil Seal
- (12) Gasket, O-ring

MODEL IDENTIFICATION

KZ1000-L

When in doubt as to the condition of a gasket or O-ring, replace it with a new one. The mating surfaces around the gasket should be free of foreign matter and perfectly smooth to avoid oil or compression leaks.

## SPECIFICATIONS

## KZ/Z1000-J1 Specifications:

Items	KZ/Z1000-J1
<b>Dimensions:</b>	
Overall length	2,265 mm, (U) 2,240 mm
Overall width	820 mm, (U) 845 mm
Overall height	1,145 mm
Wheelbase	1,520 mm
Road clearance	140 mm
Seat height	805 mm
Dry weight	230 kg
Fuel tank capacity	21.4 liters
<b>Performance:</b>	
Climbing ability	30°
Braking distance	12.5 m from 50 kph
Minimum turning radius	2.5 m
<b>Engine:</b>	
Type	4-stroke, DOHC, 4-cylinder
Cooling system	Air cooled
Bore and stroke	69.4 x 66.0 mm
Displacement	998 cc
Compression ratio	9.2
Maximum horsepower	102HP @8,500 rpm, (G) 97HP @8,500 rpm
Maximum torque	9.3 kg-m @7,000 rpm, (G) 8.8 kg-m @7,500 rpm
Valve timing:	
Inlet	Open 35° BTDC
	Close 65° ABDC
	Duration 280°
Exhaust	Open 68° BBDC
	Close 32° ATDC
	Duration 280°
Carburetion system	Mikuni carburetors, BS34 x 4
Cylinder numbering method	Left to right, 1-2-3-4
Firing order	1-2-4-3
Lubrication system	Forced lubrication (Wet sump)
Engine oil:	
Grade	SE class
Viscosity	SAE 10W40, 10W50, 20W40, or 20W50
Capacity	3.7 liters
Starting system	Electric starter
Ignition system	Battery and coil (Transistorized)
Timing advance	Mechanically advanced
Ignition timing	From 10° BTDC @1,000 rpm to 40° BTDC @3,400 rpm
Spark plugs	NGK BR8ES or ND W24ESR-U, (U) NGK B8ES or ND W24ES-U

(U): US model      (G): West German, Swiss, and Swedish models

Specifications subject to change without notice, and may not apply to every country.

(Continued on next page.)

## KZ/Z1000-J1 Specifications (Cont.):

Items	KZ/Z1000-J1
<b>Drive Train:</b>	
Primary reduction system:	
Type	Gear
Reduction ratio	1.732 (97/56)
Clutch type	Wet multi disc
Transmission:	
Type	5-speed, constant mesh, return shift
Gear ratios 1st	2.642 (37/14)
2nd	1.833 (33/18)
3rd	1.428 (30/21)
4th	1.173 (27/23)
5th	1.040 (26/25)
Final drive system:	
Type	Chain drive
Reduction ratio	2.733 (41/15)
Overall drive ratio	4.923 @Top gear
<b>Frame:</b>	
Type	Tubular, double cradle
Castor (rake angle)	27.5°
Trail	99 mm
Front tire:	
Type	Tubeless
Size	3.25V-19 4PR
Rear tire:	
Type	Tubeless
Size	4.25V-18 4PR
Front suspension:	
Type	Telescopic fork (Pneumatic)
Wheel travel	145 mm
Rear suspension:	
Type	Swing arm
Wheel travel	100 mm
Brake type:	
Front	Dual disc brake
Rear	Single disc brake
<b>Electrical Equipment:</b>	
Alternator:	
Type	Three-phase AC
Rated output	20 amp. @8,000 rpm, 14V
Voltage regulator	Short-circuit type
Battery	12V 18AH
Headlight:	
Type	Sem-sealed
Bulb	12V 60/55W (Quartz-halogen)
Tail/brake light	12V 5/21W x 2, (U) (C) 12V 8/27W x 2

(U) : US model

(C) : Canadian model

Specifications subject to change without notice, and may not apply to every country.

(Continued on next page)



## KZ/Z1000-K1, KZ1000-M1 Specifications:

Items	KZ/Z1000-K1	KZ1000-M1	
<b>Dimensions:</b>			
Overall length	2,293 mm, (U) 2,245 mm	2,245 mm	
Overall width	820 mm	*	
Overall height	1,220 mm	*	
Wheelbase	1,535 mm	*	
Road clearance	130 mm	*	
Seat height	785 mm	*	
Dry weight	234 kg, (U) 232 kg	232 kg	
Fuel tank capacity	15 liters	*	
<b>Performance:</b>			
Climbing ability	30°	*	
Braking distance	12.5 m from 50 kph	*	
Minimum turning radius	2.6 m	*	
<b>Engine:</b>			
Type	4-stroke, DOHC, 4-cylinder	*	
Cooling system	Air cooled	*	
Bore and stroke	69.4 x 66.0 mm	*	
Displacement	998 cc	*	
Compression ratio	9.2	*	
Maximum horsepower	92HP @8,000 rpm, (G) 95HP @8,500 rpm	*	
Maximum torque	8.7 kg-m @7,000 rpm, (G) 8.2HP @7,500 rpm	*	
Valve timing:			
Inlet	Open	30° BTDC	*
	Close	60° ABDC	*
	Duration	270°	*
Exhaust	Open	63° BBDC	*
	Close	27° ATDC	*
	Duration	270°	*
Carburetion system	Mikuni carburetors, BS34 x 4	*	
Cylinder numbering method	Left to right, 1-2-3-4	*	
Firing order	1-2-4-3	*	
Lubrication system	Forced lubrication (Wet sump)	*	
Engine oil:			
Grade	SE class	*	
Viscosity	SAE 10W40, 10W50, 20W40, or 20W50	*	
Capacity	3.7 liters	*	
Starting system	Electric starter	*	
Ignition system	Battery and coil (Transistorized)	*	
Timing advance	Mechanically advanced	*	
Ignition timing	From 10° BTDC @1,000 rpm to 40° BTDC @3,400 rpm	*	
Spark plugs	NGK BR8ES or ND W24ESR-U, (U) NGK B8ES or ND W24ES-U	NGK B8ES or ND W24ES-U	

(U): US model

(G): West German, Swiss, and Swedish models

\*: Identical to KZ/Z1000-K1

Specifications subject to change without notice, and may not apply to every country.

(Continued on next page.)

## KZ/Z1000-K1, KZ1000-M1 Specifications (Cont.):

Items	KZ/Z1000-K1	KZ1000-M1
<b>Drive Train:</b>		
Primary reduction system:		
Type	Gear	*
Reduction ratio	1.732 (97/56)	*
Clutch type	Wet multi disc	*
Transmission:		
Type	5-speed, constant mesh, return shift	*
Gear ratios		
1st	2.642 (37/14)	*
2nd	1.833 (33/18)	*
3rd	1.428 (30/21)	*
4th	1.173 (27/23)	*
5th	1.040 (26/25)	*
Final drive system:		
Type	Chain drive	*
Reduction ratio	2.600 (39/15)	*
Overall drive ratio	4.684 @Top gear	*
<b>Frame:</b>		
Type	Tubular, double cradle	*
Castor (rake angle)	29°	*
Trail	107 mm	*
Front tire:		
Type	Tubeless	Tube type
Size	3.25V-19 4PR, (U) (C) 3.25H-19 4PR	3.25H-19 4PR
Rear tire:		
Type	Tubeless	Tube type
Size	130/90V-16 4PR, (U) (C) 130/90-16 67H	130/90-16 67H
Front suspension:		
Type	Telescopic fork (Pneumatic)	*
Wheel travel	180 mm	*
Rear suspension:		
Type	Swing arm	*
Wheel travel	120 mm	*
Brake type:		
Front	Dual disc brake	*
Rear	Single disc brake	*
<b>Electrical Equipment:</b>		
Alternator:		
Type	Three-phase AC	*
Rated output	20 amp. @8,000 rpm, 14V	*
Voltage regulator	Short-circuit type	*
Battery	12V 18AH	*
Headlight:		
Type	Semi-sealed	Sealed
Bulb	12V 60/55W (Quartz-halogen)	12V 60/50W
Tail/brake light	12V 5/21W x 2, (U) (C) 12V 8/27W x 2	12V 8/27W x 2

(U) : US model      (C) : Canadian model  
 \* : Identical to KZ/Z1000-K1

Specifications subject to change without notice,  
 and may not apply to every country.

## TORQUE AND LOCKING AGENT

The following table lists the tightening torque for the major bolts and nuts, and the parts requiring use of a non-permanent locking agent or liquid gasket. To retorque fasteners, first loosen each bolt or nut ½ turn, one at a time, and then tighten it to the specified torque. Follow the sequence if specified. For engine fasteners, retorque them when the engine is cold (at room temperature).

NOTE: 1. Letters used in "Remark"

A : Apply a non-permanent locking agent to the threads.

G : Apply a liquid gasket to the threads or washer.

S : Tighten the fasteners following the sequence specified in this text.

### Engine Part Tightening Torque:

Part	Dia. x Pitch (mm)	Quantity	Torque		Remark	See Page
			kg-m	ft-lbs		
Air suction valve cover bolts (US model)	6 x 1.0	8*	1.0	87 in-lbs	—	6-17
Alternator cover Allen bolts	6 x 1.0	8	—	—	A	6-35
Alternator rotor bolt	12 x 1.25	1	16.0	116	—	6-34
Alternator stator Allen bolts	6 x 1.0	3	1.0	87 in-lbs	A	6-34
Breather cover bolt	8 x 1.25	1	0.60	52 in-lbs	—	6-28
Camshaft bearing cap bolts	6 x 1.0	16	1.7	12.0	S	6-21
Camshaft chain anti-jumping bolt	8 x 1.25	1	—	—	A	6-50
Camshaft chain tensioner cap	18 x 1.5	1	2.8	20	—	6-22
Camshaft sprocket bolts	6 x 1.0	4	1.5	11.0	A	6-19
Carburetor holder Allen bolts	6 x 1.0	8	—	—	A	—
Clutch hub nut	20 x 1.5	1	13.0	94	—	6-39
Clutch release mounting screws	6 x 1.0	2	—	—	A	6-31
Clutch spring bolts	6 x 1.0	5	0.90	78 in-lbs	—	6-39
Crankcase bolts						
Upper half side	6 x 1.0	5	1.0	87 in-lbs	—	6-46
Lower half side	6 x 1.0	16	1.0	87 in-lbs	A	6-46
Lower half side	8 x 1.25	8	2.5	18.0	A, S	6-46
Crankshaft main bearing cap bolts	8 x 1.25	4	2.5	18.0	S	6-50
Cylinder head						
Bolts	6 x 1.0	2	1.2	104 in-lbs	S	6-18
Nuts	10 x 1.25	12	4.0	29	S	6-18
Cylinder head cover bolts	6 x 1.0	24*	1.0	87 in-lbs	—	6-17
Engine drain plug	20 x 1.5	1	3.0	22	—	2-4
Engine mounting bolts						
Front upper (310 mm length)	10 x 1.25	1	4.0	29	—	6-43
Front lower (155 mm length)	10 x 1.25	1	4.0	29	—	6-43
Rear (283 mm length)	12 x 1.25	1	4.0	29	—	6-43
Engine mounting bracket bolts						
Front (65 mm length)	8 x 1.25	2	2.4	17.5	—	6-43
Rear (45 mm length)	8 x 1.25	2	2.4	17.5	—	6-43
Engine sprocket bolt	10 x 1.5	1	8.0	58	—	6-31

\*US model: The four out of these bolts are used to mount both the air suction valve covers and cylinder head cover.

(Continued on next page.)

## Engine Part Tightening Torque (Cont.)

Part	Dia. x Pitch (mm)	Quantity	Torque		Remark	See Page
			kg-m	ft-lbs		
Neutral switch	12 x 1.5	1	1.5	11	—	6-31
Oil filter mounting bolt	20 x 1.5	1	2.0	14.5	—	6-41
Oil pan bolts	6 x 1.0	17	1.0	87 in-lbs	—	6-41
Oil pressure switch	20 x 1.5	1	0.6	52 in-lbs	—	6-28
Oil pump mounting bolts	6 x 1.0	3	0.80	69 in-lbs	—	6-40
Right engine cover Allen bolts	6 x 1.0	6	—	—	A	6-36
Shift pedal return spring pin	8 x 1.25	1	2.0	14.5	A	6-30
Shift drum bearing holder plate bolts	6 x 1.0	2	1.0	87 in-lbs	A	6-40
Shift drum pin plate screw	6 x 1.0	1	—	—	A	6-42
Spark plugs	14 x 1.25	4	2.8	20	—	2-5
Starter clutch Allen bolts	8 x 1.25	3	4.0	29	A	6-34
Starter motor retaining bolts	6 x 1.0	2	—	—	A	6-34
Starter motor terminal nut	6 x 1.0	1	0.50	43 in-lbs	—	6-34
Timing advancer mounting bolt	8 x 1.25	1	2.5	18.0	—	6-37

## Chassis Part Tightening Torque:

Part	Dia. x Pitch (mm)	Quantity	Torque		Remark	See Page
			kg-m	ft-lbs		
Front axle clamp nuts (KZ/Z1000-J)	8 x 1.25	4	1.8	13.0	—	7-4
Front axle clamp nut (KZ/Z1000-K and M)	8 x 1.25	1	1.8	13.0	—	7-4
Front axle nut (KZ/Z1000-J)	14 x 1.5	2	7.0	51	—	7-4
Front axle nut (KZ/Z1000-K and M)	14 x 1.5	1	7.0	51	—	7-4
Front fork bottom Allen bolts	8 x 1.25	2	2.3	16.5	A,G	7-45
Front fork clamp bolts						
Lower	8 x 1.25	4	1.8	13.0	—	7-43
Upper	8 x 1.25	2	1.8	13.0	—	7-43
Front fork air valves	8 x 1.0	2	0.80	69 in-lbs	A	7-46
Front fork drain screws	4 x 0.7	2	—	—	G	2-21
Front fork top bolts		2	2.3	16.5	—	7-46
Handlebar clamp bolts	8 x 1.25	4	1.8	13.0	—	7-40
Rear axle nut	18.5 x 1.5	1	12.0	87	—	2-14
Rear shock absorber fasteners						
Lower bolts	10 x 1.25	2	3.1	22	—	7-46
Upper nuts	12 x 1.25	2	3.1	22	—	7-46
Rear sprocket nuts	10 x 1.25	6	4.0	29	—	7-11

(Continued on next page.)

## Chassis Part Tightening Torque (Cont.)

Part	Dia. x Pitch (mm)	Quantity	Torque		Remark	See Page
			kg-m	ft-lbs		
Spoke nipples (KZ1000-M)		96	0.30	26 in-lbs	—	7-12
Steering stem head bolt	14 x 1.5	1	4.3	31	—	2-19
Steering stem head clamp bolt	8 x 1.25	1	1.8	13.0	—	2-19
Swing arm pivot shaft nut	14 x 1.5	1	10.0	72	—	7-47
Tire air valve nuts	8 x 0.8	4	0.15	13 in-lbs	—	7-13
Torque link nuts	10 x 1.25	2	3.1	22	—	2-14
Turn signal mounting nuts (KZ/Z1000-J)	10 x 1.25	4	1.3	9.5	—	7-30

## Brake Part Tightening Torque:

Part	Dia. x Pitch (mm)	Quantity	Torque		Remark	See Page
			kg-m	ft-lbs		
Bleed valves	7 x 1.0	3	0.80	69 in-lbs	—	2-17
Brake hose banjo bolts	10 x 1.25	7	2.5	18.0	—	7-16
Brake lever pivot bolt	6 x 1.0	1	0.30	26 in-lbs	—	7-22
Brake lever pivot bolt locknut	6 x 1.0	1	0.60	52 in-lbs	—	7-22
Caliper holder shaft bolts	8 x 1.25	6	1.8	13.0	—	7-16
Caliper mounting bolts	10 x 1.25	4	3.3	24	—	7-16
Disc mounting bolts						
KZ/Z1000-J, K: Front	8 x 1.25	14	2.3	16.5	—	7-15
KZ1000-M: Front	10 x 1.25	8	4.0	29	—	7-15
KZ/Z1000-J, K, M: Rear	8 x 1.25	7	2.3	16.5	—	7-15
Front master cylinder clamp bolts	6 x 1.0	2	0.90	78 in-lbs	—	7-20
Rear brake reservoir hose clamp screws	—	2	0.10	9 in-lbs	—	7-20

(Continued on next page.)

**TORQUE AND LOCKING AGENT (CONT.)**

The table below, relating tightening torque to thread diameter and pitch, lists the basic torque for the bolts and nuts used on Kawasaki Motorcycles. However, the actual torque that is necessary may vary among bolts and nuts with the same thread diameter and pitch. The bolts and nuts listed on Pg. 1-9 through 1-11 vary to a greater or lesser extent from what is given in this table. Refer to this table for only the bolts and nuts not included in the table on Pg. 1-9 through 1-11. All of the values are for use with dry solvent-cleaned threads.

**Coarse threads**

	dia (mm)	pitch (mm)	kg-m	ft-lbs
	5	0.80	0.35 – 0.50	30 – 43 in-lbs
	6	1.00	0.60 – 0.90	52 – 78 in-lbs
	8	1.25	1.6 – 2.2	11.5 – 16.0
	10	1.50	3.1 – 4.2	22 – 30
	12	1.75	5.4 – 7.5	39 – 54
	14	2.00	8.3 – 11.5	60 – 83
	16	2.00	13.0 – 18.0	94 – 130
	18	2.50	18.0 – 25	130 – 181
	20	2.50	26 – 35	188 – 253

**Fine threads**

	dia (mm)	pitch (mm)	kg-m	ft-lbs
	5	0.50	0.35 – 0.50	30 – 43 in-lbs
Front fork clamp bolts	6	0.75	0.60 – 0.80	52 – 69 in-lbs
Lower	8	1.00	1.4 – 1.9	10.0 – 13.5
Upper	8	1.00	1.4 – 1.9	10.0 – 13.5
Front fork valves	10	1.25	2.6 – 3.5	19.0 – 25
Front fork drain screws	12	1.50	4.5 – 6.2	33 – 45
Front fork top bolts	14	1.50	7.4 – 10.2	54 – 74
Handlebar clamp bolts	16	1.50	11.5 – 16.0	83 – 116
Rear axle nuts	16	1.50	11.5 – 16.0	83 – 116
Rear shock absorber fasteners	18	1.50	17.0 – 23	123 – 166
Lower bolts	20	1.50	23 – 33	166 – 239
Upper nuts	20	1.50	23 – 33	166 – 239
Rear sprocket nuts	10 x 1.25		4.0	29

(Continued on next page.)

## SPECIAL TOOLS (Cont.)

Ref. No.	Part No.	Description	Quantity
1	57001-110	Spark plug wrench	1
2	57001-113	Valve lifter holder	1
3	57001-115	Piston ring pliers	1
4	57001-123	Compression gauge	1
5	57001-125	Oil pressure gauge	1
6	57001-127	Vaccum gauge set	1 set
7	57001-135	Bearing puller	1
8	57001-137	Driver	1
9	57001-143	Inside circlip pliers	1
10	57001-144	Outside circlip pliers	1
11	57001-147	Piston base	1 set
12	57001-162	Valve guide reamer	1
13	57001-163	Valve guide arbor	1
14	57001-183	Front fork cylinder holder handle	1
15	57001-241	Valve spring compressor	1
16	57001-243	Adaptor — use with 57001-241.	1
17	57001-266	Oil seal guide	1
18	57001-305	Clutch holder	1
19	57001-306	Holder	1
20	57001-308	Rotor holder	1
21	57001-317	Adapter — use with 57001-135.	1
22	57001-382	Driver	1
23	57001-900	Engine stand	1
24	57001-910	Piston pin puller	1
25	57001-980	Electrotester	1
26	57001-983	Hand tester	1
27	57001-1017	Fuel level gauge	1
28	57001-1057	Adapter — use with 57001-183.	1
29	57001-1058	Oil seal and bearing remover assembly	1
30	57001-1061	Adapter — use with 57001-1058.	1
31	57001-1063	Rim protectors	1 set
32	57001-1065	Tire changer	1
33	57001-1072	Bead breaker	1
34	57001-1074	Adapter — use with 57001-137.	1
35	57001-1075	Driver press shaft	1
36	57001-1076	Driver — use with 57001-1075.	1
37	57001-1094	Piston ring compressor	4
38	57001-1099	Rotor puller	1
39	57001-1100	Stem nut wrench	1
40	57001-1104	Driver	1

(Continued on next page.)

## SPECIAL TOOLS (Cont.)

Ref. No.	Part No.	Description	Quantity
41	57001-1106	Driver — use with 57001-1075.	1
42	57001-1107	Stem bearing remover	1
43	57001-1111	Valve seat cutter case	1
44	57001-1112	Cutter separate case	1
45	57001-1116	Valve seat cutter, 45° — $\phi$ 35.0	1
46	57001-1117	Valve seat cutter, 45° — $\phi$ 41.5	1
47	57001-1121	Outside cutter, 32° — $\phi$ 35.0	1
48	57001-1122	Outside cutter, 32° — $\phi$ 38.5	1
49	57001-1124	Inside cutter, 60° — $\phi$ 41.0	1
50	57001-1126	Cutter holder, 7.0 mm	1
51	57001-1128	Cutter holder, bar	1
52	57001-1129	Bearing driver set — contains 57001-1130 through 57001-1149.	1
53	57001-1130	Bearing driver case	1
54	57001-1131	Driver separate case	1
55	57001-1151	Rotor puller adapter	1

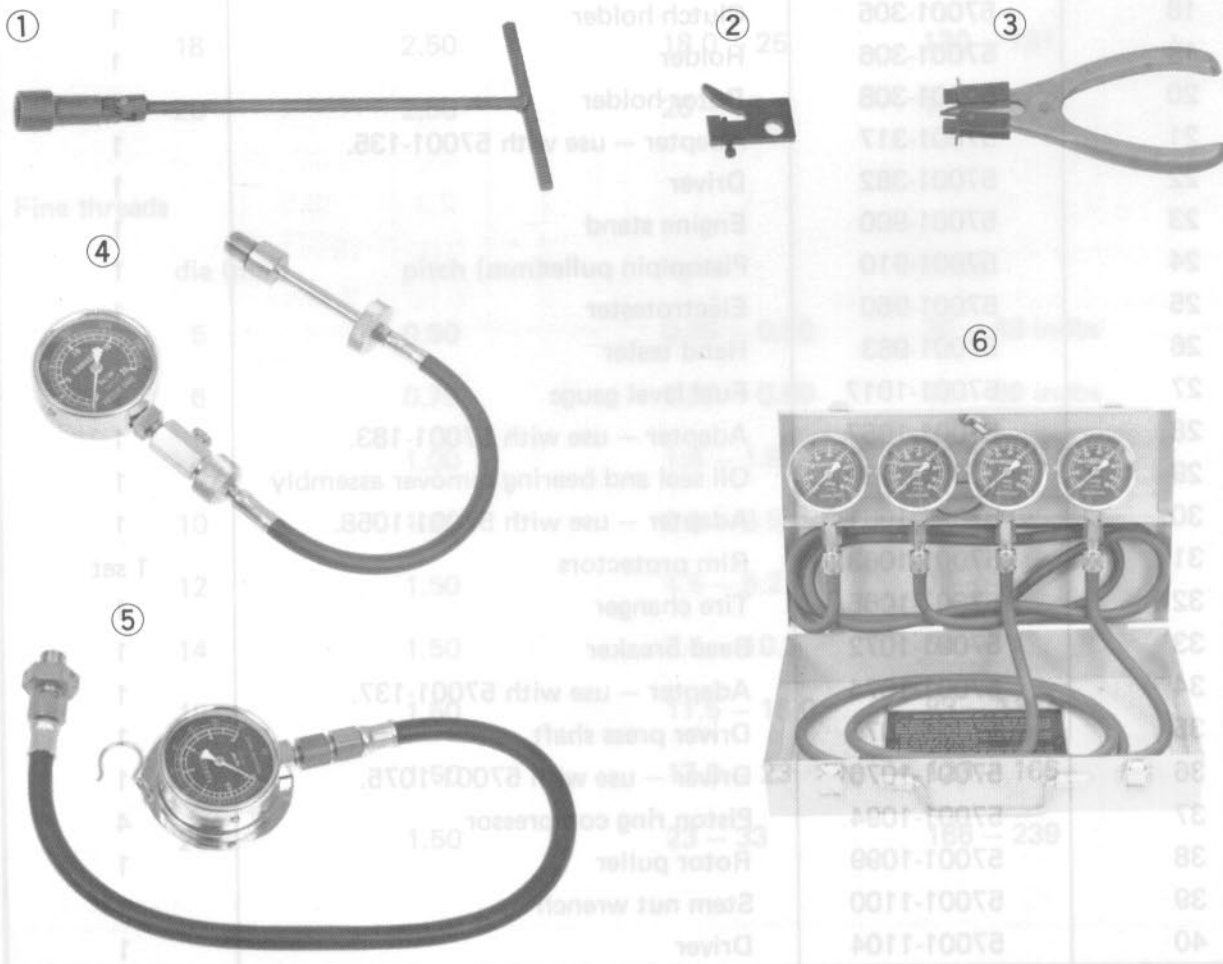

(Continued on next page.)



SPECIAL TOOLS (Cont.)

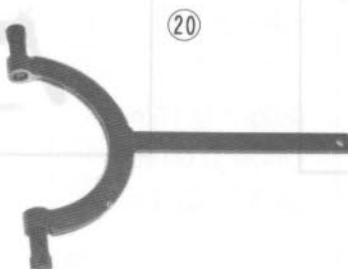
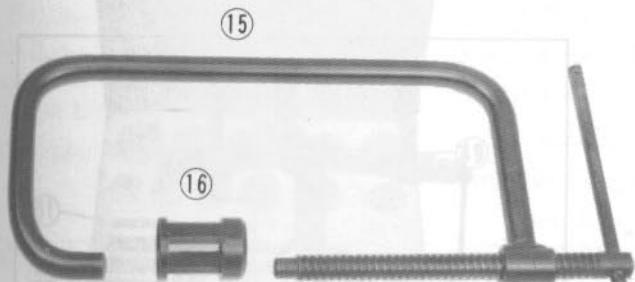
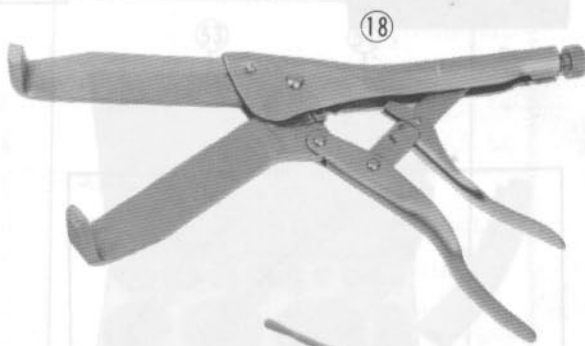
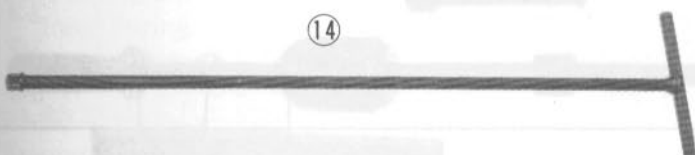
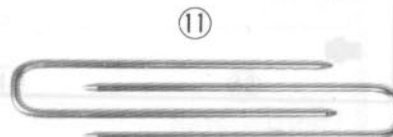
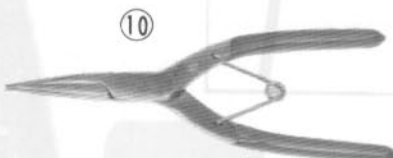
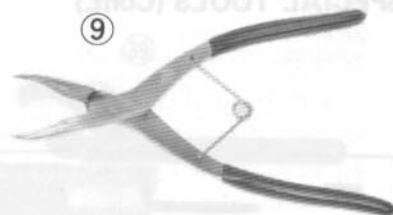

(Continued on next page.)





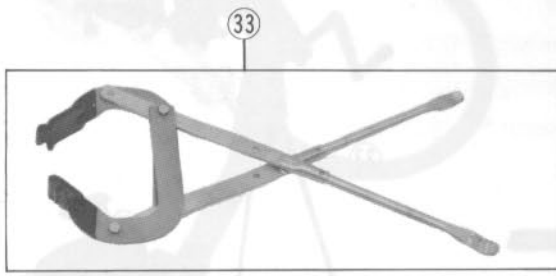
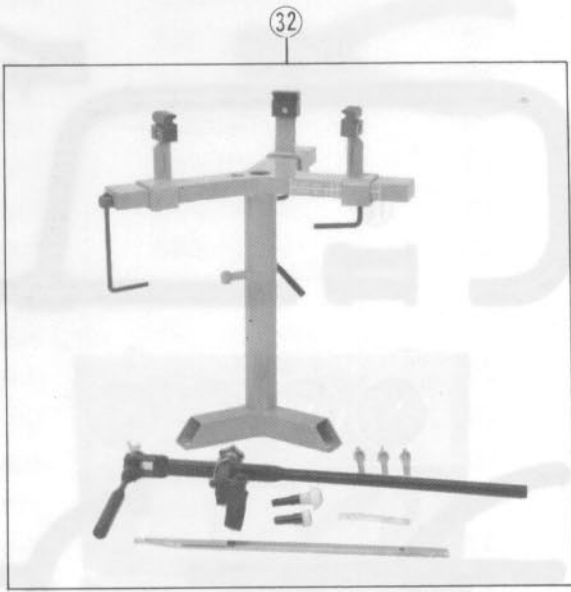
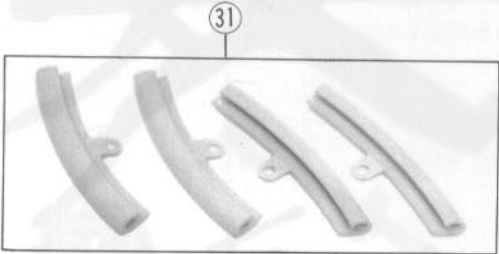
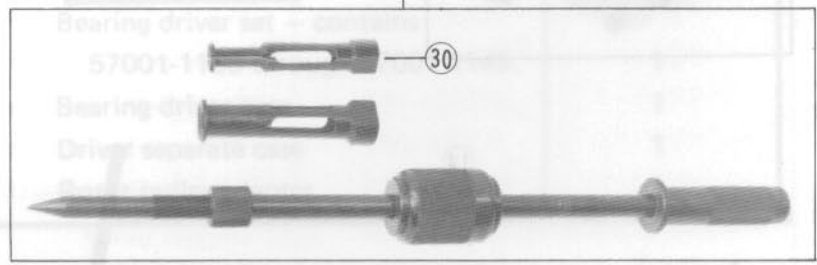
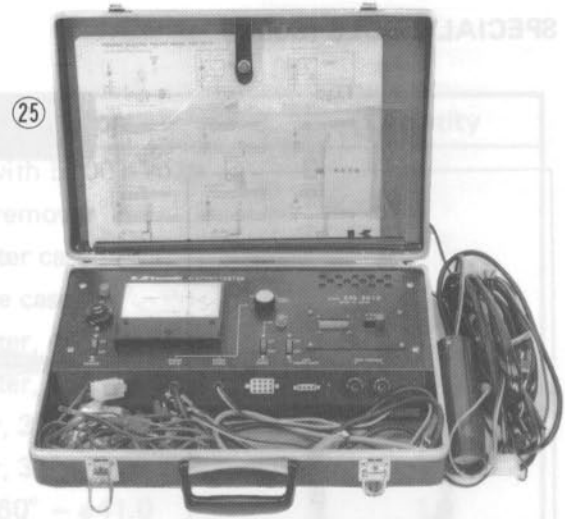
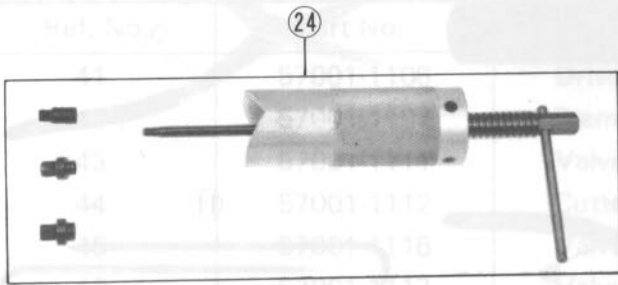

(Continued on next page.)

SPECIAL TOOLS (Cont.)

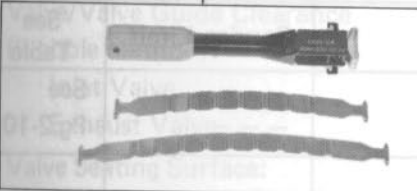

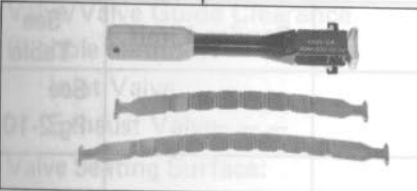
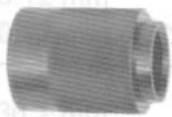
(Continued on next page.)

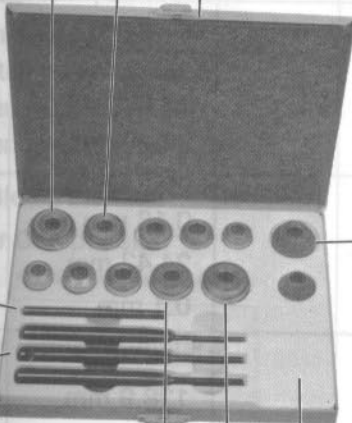
SPECIAL TOOLS (Cont.)

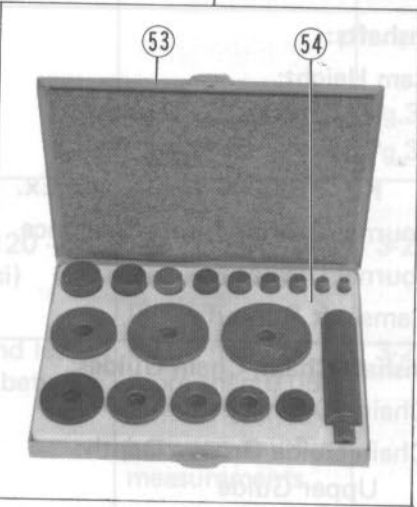
 <p>37</p>	<p>38</p> 	<p>39</p> 
 <p>40</p> <p>41</p> <p>42</p>		
 <p>43</p> <p>44</p> <p>45</p> <p>46</p> <p>47</p> <p>48</p> <p>49</p> <p>50</p> <p>51</p>	 <p>55</p>	 <p>52</p> <p>53</p> <p>54</p>

(Continued on next page)

(page text not printed)

## SERVICE DATA

The following tables list the service data which show criteria for servicing major parts. Although reliable measurements can only be obtained by using the proper instruments and following the procedures explained in this text, detail has not been explained in this section. See each section for a detailed account.

### Engine:

Item	Standard	Service Limit	See Table
<b>Throttle Grip:</b> Grip play	2 – 3 mm	---	See Pg.2-10
<b>Carburetors:</b>			
Idle Speed	1,000 ± 50 rpm	---	2-6
Synchronization	Under 2 cmHg difference	---	2-7
<b>Jet Needle Clip Position:</b>			
US Models	Non-adjustable	---	3-2
Other than US Models	3rd groove from top	---	3-2
<b>Pilot Screw Position:</b>			
US Models	Non-adjustable	---	3-2
Other than US Models	1¼ turns out	---	3-2
Service Fuel Level	3 ± 1 mm	---	3-3
<b>Camshafts:</b>			
<b>Cam Height:</b>			
KZ/Z1000-J:   Inlet	36.910 – 37.090 mm	36.80 mm	3-5
Exhaust	36.510 – 36.690 mm	36.40 mm	3-5
KZ/Z1000-K, M: In. and Ex.	36.006 – 36.186 mm	35.91 mm	3-5
Journal/Bearing Insert Clearance	0.020 – 0.070 mm	0.16 mm	3-6
Journal Diameter	24.459 – 24.480 mm	24.42 mm	3-7
Camshaft Runout	Under 0.03 mm	0.1 mm	3-8
<b>Camshaft Chain, Chain Guides:</b>			
Chain 20-Link Length	127.00 – 127.16 mm	128.9 mm	3-9
Chain Guide Groove Depth:			
Upper Guide	0 mm	4.3 mm	3-10
Front and Rear Guides	1.0 – 1.5 mm	3.3 mm	3-10
<b>Cylinder Head Valves:</b>			
Valve Clearance:   In. and Ex.	0.05 – 0.15 mm	---	2-4
Cylinder Head Warp	Under 0.05 mm	---	3-11
Combustion Chamber Volume	39.5 – 40.3 cc	---	3-12
<b>Valve Head Thickness:</b>			
Inlet Valve	1 mm	0.5 mm	3-13
Exhaust Valve	1 mm	0.7 mm	3-13
Valve Stem Bend	Under 0.01 mm	0.05 mm	3-14

(Continued on next page.)

## Engine (Cont.):

Item	Standard	Service Limit	See Table
Valve Stem Diameter:			
Inlet Valve	6.965 – 6.980 mm	6.95 mm	3-15
Exhaust Valve	6.955 – 6.970 mm	6.94 mm	3-15
Valve Guide Inside Diameter	7.000 – 7.015 mm	7.08 mm	3-16
Valve/Valve Guide Clearance (Wobble Method):			
Inlet Valve	0.05 – 0.12 mm	0.24 mm	3-17
Exhaust Valve	0.07 – 0.13 mm	0.22 mm	3-17
Valve Seating Surface:			
Outside Diameter: In.	35.9 – 36.1 mm	---	3-18
Ex.	30.9 – 31.1 mm	---	3-18
Width: In. and Ex.	0.8 – 1.2 mm	---	3-18
Valve Spring Tension:			
Inner Spring	25.75 – 28.45 kg @23.6 mm	23.7 kg	3-20
Outer Spring	47.0 – 51.8 kg @25.6 mm	43.3 kg	3-20
Valve Spring Squareness:			
Inner Spring	---	1.3 mm	3-21
Outer Spring	---	1.5 mm	3-21
<b>Clean Air System (US Model):</b>			
Vacuum Switch Valve			
Switching Pressure:			
When raising vacuum	35 – 39 cmHg	---	Pg.3-14
When lowering vacuum	27 – 31 cmHg	---	Pg.3-14
<b>Cylinder Block, Pistons:</b>			
Cylinder Compression	11.2 – 13.2 kg/cm <sup>2</sup> (1,120 – 1,320 kPa, 159 – 188 psi)	See Pg.3-15 for detailed information.	3-22
Cylinder Inside Diameter	69.400 – 69.412 mm, and less than 0.01 mm difference between any two measurements	69.50 mm, or more than 0.05 mm difference between any two measurements	3-23
Piston Diameter	69.342 – 69.357 mm	69.2 mm	3-24
Piston/Cylinder Clearance	0.043 – 0.070 mm	---	3-25
Piston Ring/Groove Clearance:			
Top Ring	0.030 – 0.070 mm	0.17 mm	3-26
2nd Ring	0.020 – 0.060 mm	0.16 mm	3-26
Piston Ring Thickness:			
Top Ring	0.970 – 0.990 mm	0.90 mm	3-27
2nd Ring	1.170 – 1.190 mm	1.10 mm	3-27

(Continued on next page.)

## Engine (Cont.):

Item	Standard	Service Limit	See Table
<b>Piston Ring Groove Width:</b>			
Top Ring Groove	1.02 – 1.04 mm	1.12 mm	3-28
2nd Ring Groove	1.21 – 1.23 mm	1.31 mm	3-28
Oil Ring Groove	2.51 – 2.53 mm	2.61 mm	3-28
Piston Ring End Gap: Top and 2nd	0.20 – 0.40 mm	0.7 mm	3-29
Piston Pin Diameter	16.995 – 17.000 mm	16.96 mm	3-30
Piston Pin Hole Diameter	17.004 – 17.011 mm	17.08 mm	3-30
Con-Rod Small End Diameter	17.003 – 17.014 mm	17.05 mm	3-30
<b>Crankshaft, Connecting Rods:</b>			
Con-Rod Bend, Twist/100 mm	Under 0.05 mm	0.2 mm	3-31
Con-Rod Big End Radial Clearance	0.016 – 0.030 mm	0.08 mm	3-32
Con-Rod Big End Side Clearance	0.030 – 0.040 mm	0.6 mm	3-33
Crankshaft Runout	Under 0.04 mm	0.10 mm	3-34
Outer Race Side Clearance	0.2 – 0.3 mm	0.5 mm	3-35
<b>Clutch:</b>			
Clutch Lever Play	2 – 3 mm	---	Pg.2-13
Release Adjusting Screw Position	¼ turn out	---	Pg.2-12
Clutch Spring Tension	23.5 – 26.5 kg @23.5 mm	22.5 kg	3-36
Friction Plate Thickness	2.9 – 3.1 mm	2.8 mm	3-37
Friction, Steel Plate Warp	Under 0.2 mm	0.3 mm	3-38
Friction Plate/Clutch Housing Clearance	0.35 – 0.65 mm	0.9 mm	3-39
Clutch Housing Gear/Primary Gear Backlash	0.03 – 0.10 mm	0.14 mm	3-40
Clutch Housing Inside Diameter	57.000 – 57.030 mm	57.06 mm	3-41
Clutch Housing Bearing Collar Outside Diameter	56.921 – 56.940 mm	56.90 mm	3-41
<b>Transmission, Shift Mechanism:</b>			
Shift Fork Ear Thickness	5.9 – 6.0 mm	5.8 mm	3-42
Shift Fork Guide Pin Diameter	7.990 – 8.005 mm	7.94 mm	3-43
Shift Drum Groove Width	8.05 – 8.20 mm	8.25 mm	3-44
Gear Backlash	0.06 – 0.23 mm	0.30 mm	3-45
Width of Shift Fork Groove on Gears	6.05 – 6.15 mm	6.25 mm	3-46
Gear/Shaft, Gear/Bushing Clearance:			
O1	0.027 – 0.061 mm	0.16 mm	3-47
O2, D5	0.025 – 0.075 mm	0.17 mm	3-47
O3, D4	0.020 – 0.062 mm	0.16 mm	3-47

(Continued on next page.)

## Engine (Cont.):

Item	Standard	Service Limit	See Table
<b>Engine Lubrication System:</b>			
Engine Oil:			
Grade	SE class	---	2-2
Viscosity	10W40, 10W50, 20W40 or 20W50	---	2-2
Capacity: When filter is changed.	3.7 liters	---	2-2
When filter is not changed.	3.0 liters	---	2-2
Oil Pressure @3,000 rpm, 60°C (140°F)	About 0.2 kg/cm <sup>2</sup> (20 kPa, 2.8 psi)	---	3-48
Pump Gear/Pump Body Clearance	0.011 – 0.083 mm	0.14 mm	3-50

## Chassis:

Item	Standard	Service Limit	See Table
<b>Wheels:</b>			
Tire Tread Depth:			
KZ/Z1000-J: Front	3.8 mm		
Rear	6.7 mm		
KZ/Z1000-K: Front	3.5 mm	See Table 2-14 on Pg.2-22	---
Rear	6.2 mm		
KZ1000-M: Front	3.5 mm		
Rear	7.4 mm		
Tire Air Pressure	See Table 4-1 on Pg.4-4	---	---
Rim Runout:			
KZ/Z1000-J, K: Axial	---	0.5 mm	4-3
Radial	---	0.8 mm	4-3
KZ1000-M: Axial and Radial	---	2 mm	2-16
Axle Runout/100 mm	Under 0.05 mm	0.7 mm	4-4
<b>Sprockets:</b>			
Engine Sprocket Diameter	79.01 – 79.21 mm	78.3 mm	4-8
Rear Sprocket Diameter:			
39T	224.59 – 225.09 mm	224.3 mm	4-6
41T	236.72 – 237.22 mm	236.4 mm	4-6
Rear Sprocket Warp	Under 0.4 mm	0.5 mm	4-7
<b>Drive Chain:</b>			
Chain Slack	30 – 35 mm	Less than 30 mm, or more than 40 mm	2-8
20-Link Length	381.0 – 381.8 mm	389 mm	2-10

(Continued on next page.)

## Chassis (Cont.):

Item	Standard	Service Limit	See Table
<b>Brakes:</b>			
Pad Lining Thickness:			
Front	3.5 mm	1mm	2-11
Rear	5 mm	1mm	2-11
Brake Fluid Grade	D.O.T.3	---	Pg.2-16
Brake Light Switch:			
Front	Non-adjustable	---	---
Rear	On after 15 mm pedal travel	---	Pg.2-18
Brake Pedal Position:			
KZ1000-J, M US, Canadian Models	8 - 12 mm	---	4-8
Z1000-J other than US, Canadian Models	13 - 17 mm	---	4-8
KZ/Z1000-K All Models	8 - 12 mm	---	4-8
Front Master Cylinder Parts:			
Cylinder Inside Diameter	15.870 - 15.933 mm	15.95 mm	4-9
Piston Outside Diameter	15.827 - 15.854 mm	15.80 mm	4-9
Primary Cup Diameter	16.15 - 16.65 mm	16.0 mm	4-9
Secondary Cup Diameter	16.6 - 17.0 mm	16.4 mm	4-9
Spring Free Length	36.6 - 40.6 mm	34.8 mm	4-10
Rear Master Cylinder Parts:			
Cylinder Inside Diameter	14.000 - 14.063 mm	14.08 mm	4-9
Piston Outside Diameter	13.823 - 13.850 mm	13.80 mm	4-9
Primary Cup Diameter	14.2 - 14.6 mm	14.1 mm	4-9
Secondary Cup Diameter	14.75 - 15.25 mm	14.6 mm	4-9
Spring Free Length	34.5 - 38.5 mm	32.8mm	4-10
Caliper Parts (Front and Rear):			
Cylinder Inside Diameter	42.85 - 42.90 mm	42.92 mm	4-11
Piston outside Diameter	42.77 - 42.82 mm	42.75 mm	4-11
Disc Runout (Front and Rear)	Under 0.15 mm	0.3 mm	4-12
Disc Thickness:			
Front	4.8 - 5.1 mm	4.5 mm	4-13
Rear	6.8 - 7.1 mm	6 mm	4-13
<b>Front Fork:</b>			
Oil Type	SAE 10W20	---	2-13
Oil Capacity:			
KZ/Z1000-J	327 ±4 cc (when changing oil: about 300 cc)	---	2-13
KZ/Z1000-K, M	351 ±4cc (when changing oil: about 320 cc)	---	2-13
Oil Level:			
KZ/Z1000-J	110 ± 2 mm	---	2-13
KZ/Z1000-K, M	184 ± 2 mm	---	2-12
Air Pressure:			
KZ1000-J US, Canadian Models	0.25 - 0.35 kg/cm <sup>2</sup> (25 - 35 kPa, 3.6 - 5.0 psi)	---	4-14

(Continued on next page.)



## Chassis (Cont.):

Item	Standard	Service Limit	See Table
Z1000-J other than US, Canadian Models	0.45 – 0.55 kg/cm <sup>2</sup> (45 – 55 kPa, 6.4 – 7.8 psi)	---	4-14
KZ/Z1000-K All Models, KZ 1000-M All Models	0.40 – 0.60 kg/cm <sup>2</sup> (40 – 60 kPa, 5.7 – 8.5 psi)	---	4-14
Fork Spring Free Length:			
KZ1000-J US, Canadian Models	554 mm	543 mm	4-15
Z1000-J other than US, Canadian Models	529 mm	518 mm	4-15
KZ/Z1000-K All Models, KZ 1000-M All Models:			
Short Spring	130.5 mm	128 mm	4-15
Long Spring	470 mm	461 mm	4-15
<b>Swing Arm:</b>			
Sleeve Outside Diameter	24.987 – 25.000 mm	24.96 mm	4-20
Pivot Shaft Runout	Under 0.10 mm	0.7 mm	4-21

## Electrical:

Item	Standard	Service Limit	See Table
<b>Charging System:</b>			
Regulator/Rectifier Output Voltage	Battery voltage – 15V	---	5-2
Alternator Output Voltage @4,000 rpm, no loads	About 50V	---	5-3
Stator Coil Resistance	0.36 – 0.54 Ω	---	5-4
<b>Ignition System:</b>			
Spark plugs:			
US Models	NGK B8ES or ND W24ES-U	---	2-3
Other than US Models	NGK BR8ES or ND W24ESR-U	---	2-3
Plug Gap	0.7 – 0.8 mm	---	2-3
Ignition Coils:			
Arcing Distance (3-Needle Method)	7 mm or more	---	5-7
Primary Winding Resistance	1.8 – 2.8 Ω	---	5-8
Secondary winding Resistance	10.4 – 15.6 kΩ	---	5-8
Pickup Coil Resistance	360 – 540 Ω	---	5-10
Igniter Resistance	See Table 5-12 on Pg. 5-15.	---	---

(Continued on next page.)

Electrical (Cont.):

Item	Standard	Service Limit	See Table
<b>Electric Starter System:</b>			
Stator Motor:			
Brush Length	12.0 – 13.0 mm	6 mm	5-14
Brush Spring Tension	560 – 680 grams	---	Pg.5-18
Commutator Groove Depth	0.5 – 0.8 mm	0.2 mm	5-15
<b>Fuel Gauge:</b>			
Resistance of Fuel Level Sender:			
Full	0.5 – 5.5 Ω	---	5-27
Empty	102 – 118 Ω	---	5-27
Fuel Gauge Internal Resistance:			
KZ/Z1000-J, K	170 – 185 Ω	---	5-28
KZ1000-M	50 – 60 Ω	---	5-28

(Continued on next page)

(Continued on next page)

KZ1000-J1 Wiring Diagram  
(US, Canadian Models)

# KZ1000-J1 Wiring Diagram (US, Canadian Models)

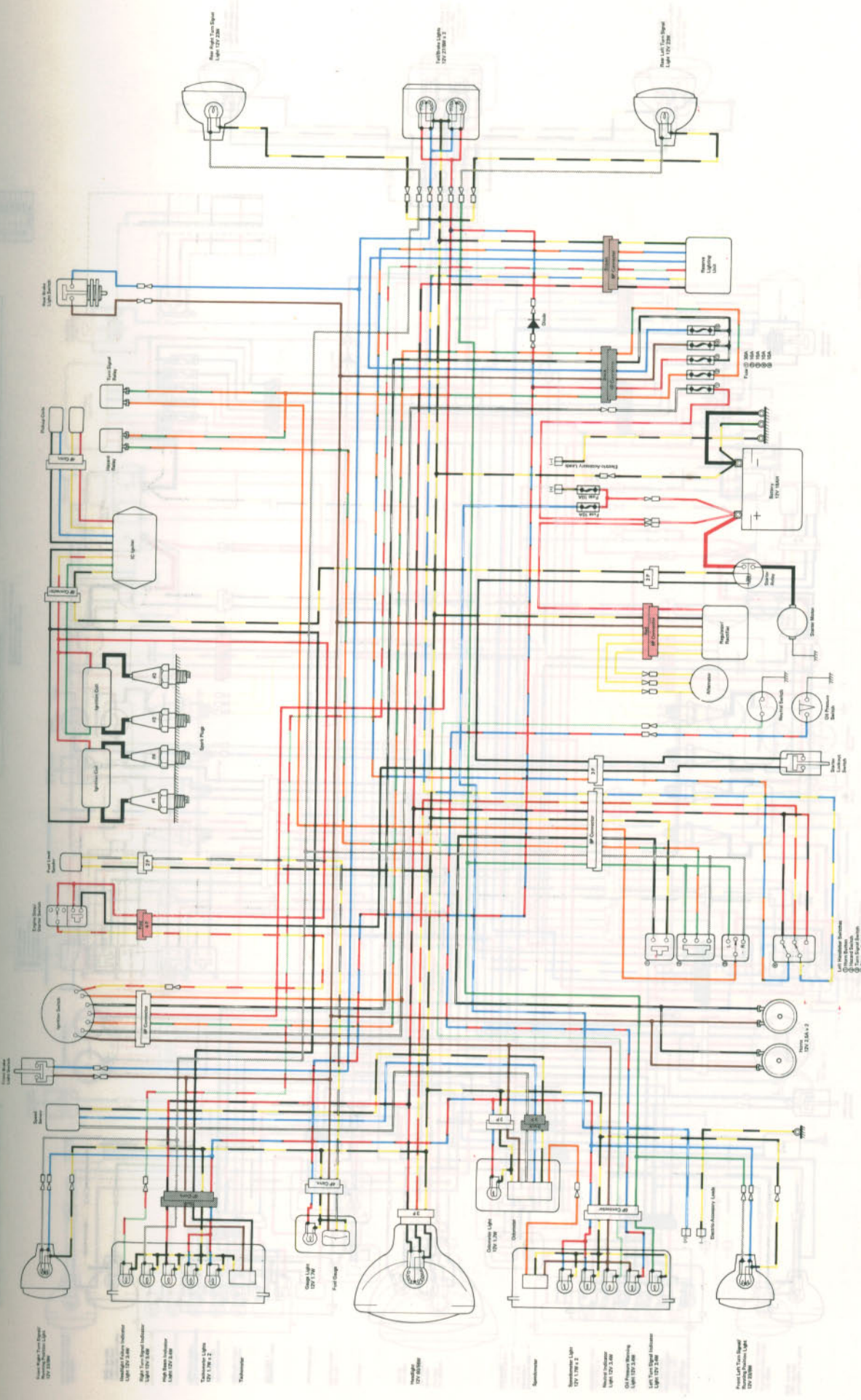

Color Code	Wire
Red	Red
Blue	Blue
Yellow	Yellow
Green	Green
Black	Black
White	White
Grey	Grey
Orange	Orange
Purple	Purple
Brown	Brown
Pink	Pink
Light Blue	Light Blue
Light Green	Light Green
Light Yellow	Light Yellow
Light Purple	Light Purple
Light Brown	Light Brown
Light Pink	Light Pink
Light Light Blue	Light Light Blue
Light Light Green	Light Light Green
Light Light Yellow	Light Light Yellow
Light Light Purple	Light Light Purple
Light Light Brown	Light Light Brown
Light Light Pink	Light Light Pink

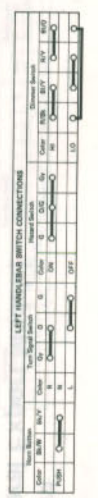
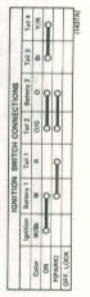

Legend:  
 ( ) Ground to Chassis  
 ( ) Ground to Battery  
 ( ) Ground to Engine Block

Electrical (Cont.)

Z1000-J1 Wiring Diagram (European, General Export Models)

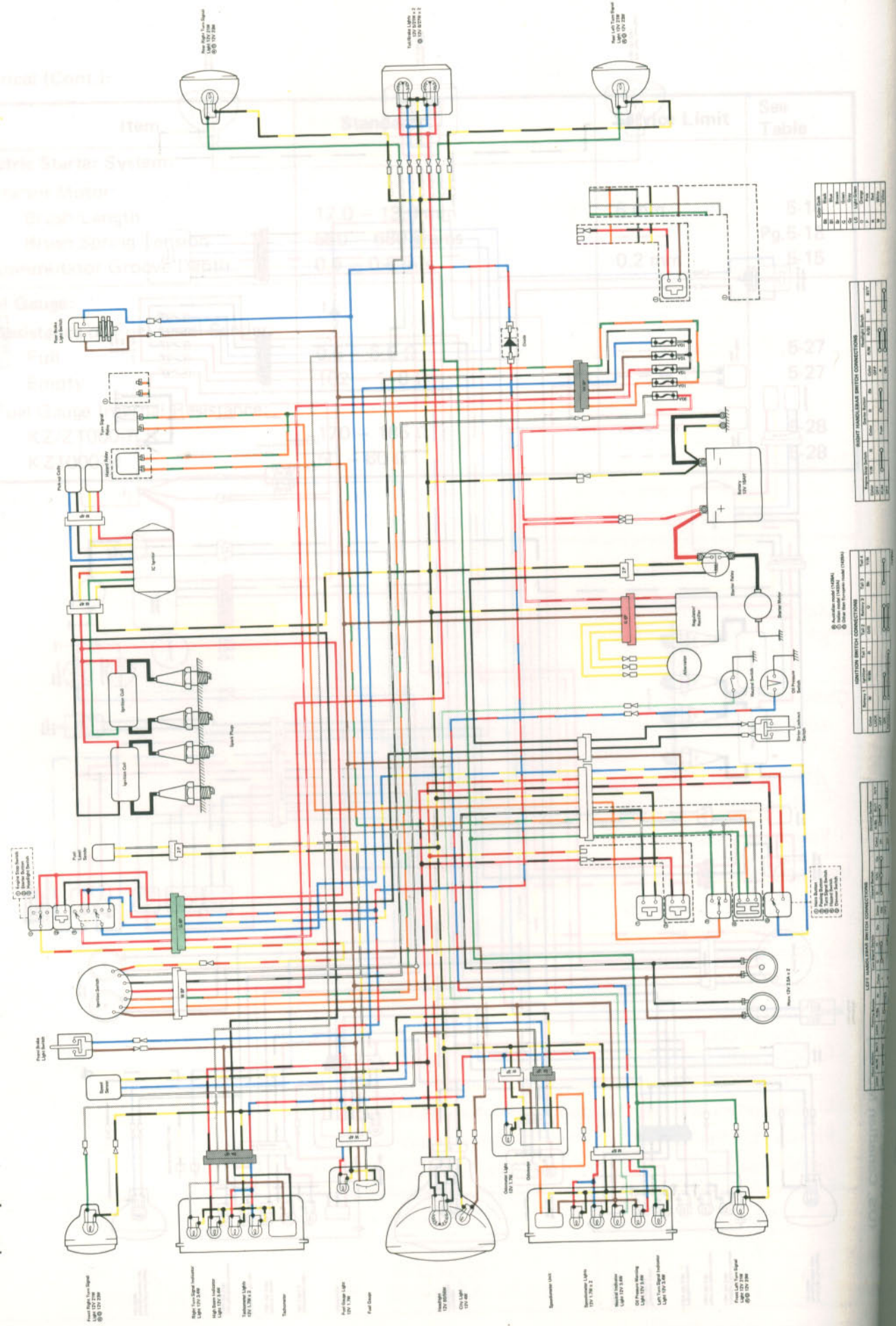

KZ1000-K1 Wiring Diagram (US, Canadian Models)

# KZ1000-K1 Wiring Diagram (US, Canadian Models)

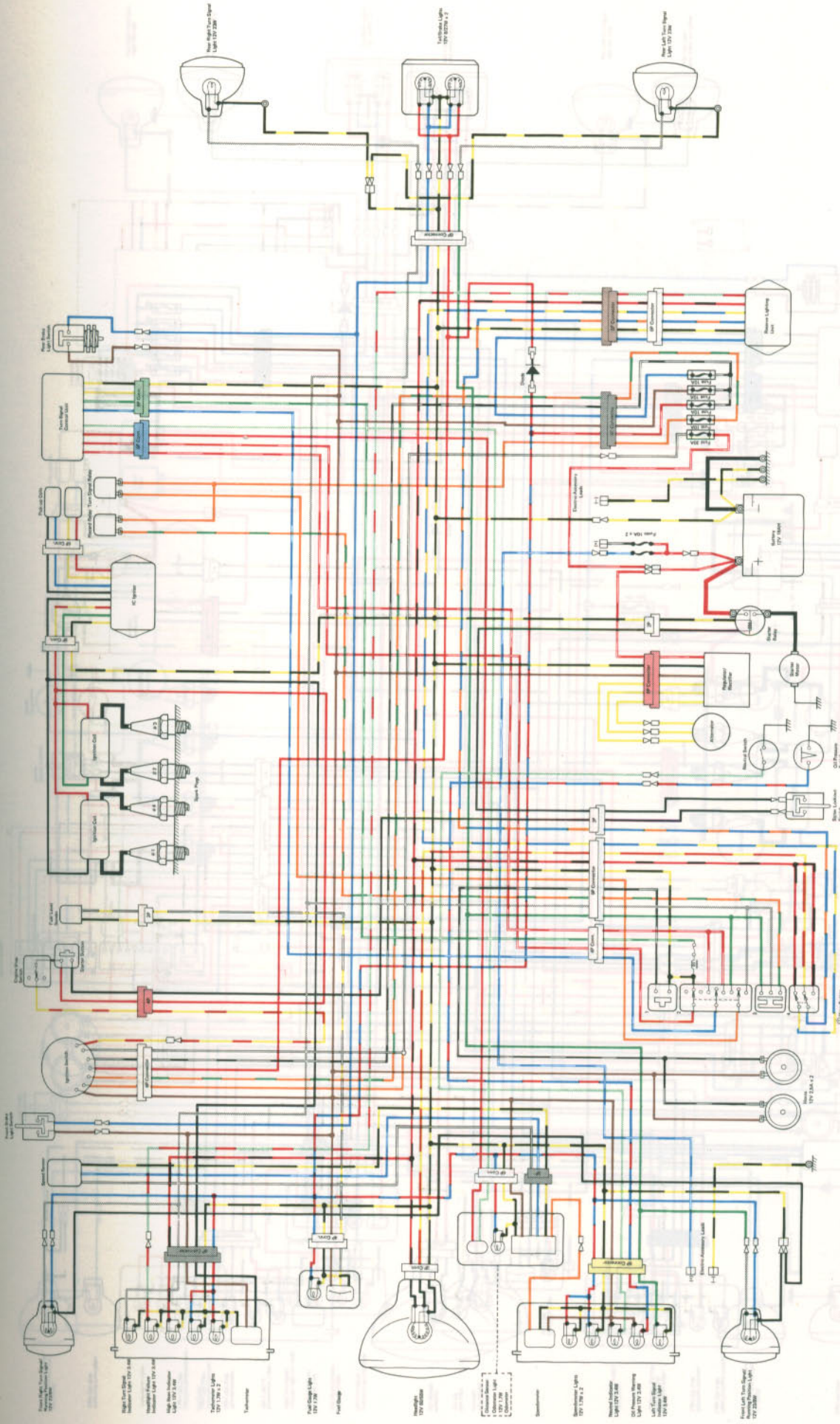

Color Code	Wire Color
1	Black
2	Blue
3	Green
4	Red
5	Yellow
6	White
7	Grey
8	Brown
9	Pink
10	Orange
11	Light Blue
12	Light Green
13	Light Red
14	Light Yellow
15	Light Grey
16	Light Brown
17	Light Pink
18	Light Orange
19	Light Light Blue
20	Light Light Green
21	Light Light Red
22	Light Light Yellow
23	Light Light Grey
24	Light Light Brown
25	Light Light Pink
26	Light Light Orange
27	Light Light Light Blue
28	Light Light Light Green
29	Light Light Light Red
30	Light Light Light Yellow
31	Light Light Light Grey
32	Light Light Light Brown
33	Light Light Light Pink
34	Light Light Light Orange
35	Light Light Light Light Blue
36	Light Light Light Light Green
37	Light Light Light Light Red
38	Light Light Light Light Yellow
39	Light Light Light Light Grey
40	Light Light Light Light Brown
41	Light Light Light Light Pink
42	Light Light Light Light Orange
43	Light Light Light Light Light Blue
44	Light Light Light Light Light Green
45	Light Light Light Light Light Red
46	Light Light Light Light Light Yellow
47	Light Light Light Light Light Grey
48	Light Light Light Light Light Brown
49	Light Light Light Light Light Pink
50	Light Light Light Light Light Orange

Switch	Terminal 1	Terminal 2	Terminal 3	Terminal 4
Ignition Switch	IGN	IGN	IGN	IGN
Left Handlebar Switch	IGN	IGN	IGN	IGN
Right Handlebar Switch	IGN	IGN	IGN	IGN
Horn Button	IGN	IGN	IGN	IGN
Horn Relay	IGN	IGN	IGN	IGN
Horn Bell	IGN	IGN	IGN	IGN
Horn Switch	IGN	IGN	IGN	IGN
Horn Switch Screw	IGN	IGN	IGN	IGN
Horn Switch Spring	IGN	IGN	IGN	IGN
Horn Switch Spring Adjuster	IGN	IGN	IGN	IGN
Horn Switch Spring Adjuster Screw	IGN	IGN	IGN	IGN
Horn Switch Spring Adjuster Screw Lock	IGN	IGN	IGN	IGN

Switch	Terminal 1	Terminal 2	Terminal 3	Terminal 4
Ignition Switch	IGN	IGN	IGN	IGN
Left Handlebar Switch	IGN	IGN	IGN	IGN
Right Handlebar Switch	IGN	IGN	IGN	IGN
Horn Button	IGN	IGN	IGN	IGN
Horn Relay	IGN	IGN	IGN	IGN
Horn Bell	IGN	IGN	IGN	IGN
Horn Switch	IGN	IGN	IGN	IGN
Horn Switch Screw	IGN	IGN	IGN	IGN
Horn Switch Spring	IGN	IGN	IGN	IGN
Horn Switch Spring Adjuster	IGN	IGN	IGN	IGN
Horn Switch Spring Adjuster Screw	IGN	IGN	IGN	IGN
Horn Switch Spring Adjuster Screw Lock	IGN	IGN	IGN	IGN

Switch	Terminal 1	Terminal 2	Terminal 3	Terminal 4
Ignition Switch	IGN	IGN	IGN	IGN
Left Handlebar Switch	IGN	IGN	IGN	IGN
Right Handlebar Switch	IGN	IGN	IGN	IGN
Horn Button	IGN	IGN	IGN	IGN
Horn Relay	IGN	IGN	IGN	IGN
Horn Bell	IGN	IGN	IGN	IGN
Horn Switch	IGN	IGN	IGN	IGN
Horn Switch Screw	IGN	IGN	IGN	IGN
Horn Switch Spring	IGN	IGN	IGN	IGN
Horn Switch Spring Adjuster	IGN	IGN	IGN	IGN
Horn Switch Spring Adjuster Screw	IGN	IGN	IGN	IGN
Horn Switch Spring Adjuster Screw Lock	IGN	IGN	IGN	IGN

# Z1000-K1 Wiring Diagram (European, General Export Models)

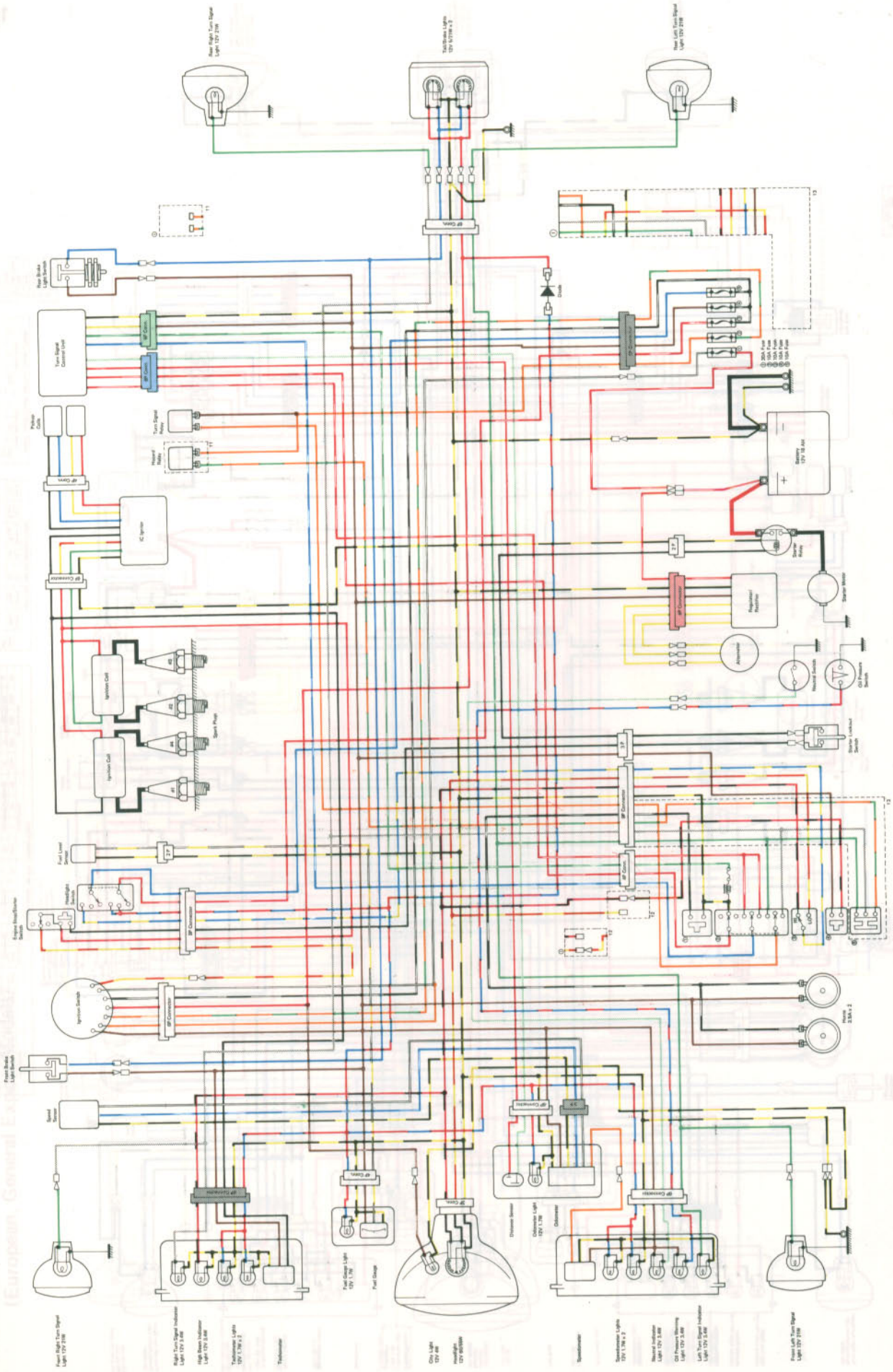

Color	Code
Red	1
Green	2
Blue	3
Yellow	4
Black	5
White	6
Brown	7
Pink	8
Grey	9
Orange	10
Light Blue	11
Light Green	12
Light Yellow	13
Light Purple	14
Light Brown	15
Light Grey	16
Light Orange	17
Light Blue-Green	18
Light Yellow-Green	19
Light Purple-Green	20
Light Brown-Green	21
Light Grey-Green	22
Light Orange-Green	23
Light Blue-Black	24
Light Green-Black	25
Light Yellow-Black	26
Light Purple-Black	27
Light Brown-Black	28
Light Grey-Black	29
Light Orange-Black	30

Color	Code
Red	1
Green	2
Blue	3
Yellow	4
Black	5
White	6
Brown	7
Pink	8
Grey	9
Orange	10
Light Blue	11
Light Green	12
Light Yellow	13
Light Purple	14
Light Brown	15
Light Grey	16
Light Orange	17
Light Blue-Green	18
Light Yellow-Green	19
Light Purple-Green	20
Light Brown-Green	21
Light Grey-Green	22
Light Orange-Green	23
Light Blue-Black	24
Light Green-Black	25
Light Yellow-Black	26
Light Purple-Black	27
Light Brown-Black	28
Light Grey-Black	29
Light Orange-Black	30

Color	Code
Red	1
Green	2
Blue	3
Yellow	4
Black	5
White	6
Brown	7
Pink	8
Grey	9
Orange	10
Light Blue	11
Light Green	12
Light Yellow	13
Light Purple	14
Light Brown	15
Light Grey	16
Light Orange	17
Light Blue-Green	18
Light Yellow-Green	19
Light Purple-Green	20
Light Brown-Green	21
Light Grey-Green	22
Light Orange-Green	23
Light Blue-Black	24
Light Green-Black	25
Light Yellow-Black	26
Light Purple-Black	27
Light Brown-Black	28
Light Grey-Black	29
Light Orange-Black	30

Color	Code
Red	1
Green	2
Blue	3
Yellow	4
Black	5
White	6
Brown	7
Pink	8
Grey	9
Orange	10
Light Blue	11
Light Green	12
Light Yellow	13
Light Purple	14
Light Brown	15
Light Grey	16
Light Orange	17
Light Blue-Green	18
Light Yellow-Green	19
Light Purple-Green	20
Light Brown-Green	21
Light Grey-Green	22
Light Orange-Green	23
Light Blue-Black	24
Light Green-Black	25
Light Yellow-Black	26
Light Purple-Black	27
Light Brown-Black	28
Light Grey-Black	29
Light Orange-Black	30

**KZ1000-M1 Wiring Diagram (US, Canadian Models)**

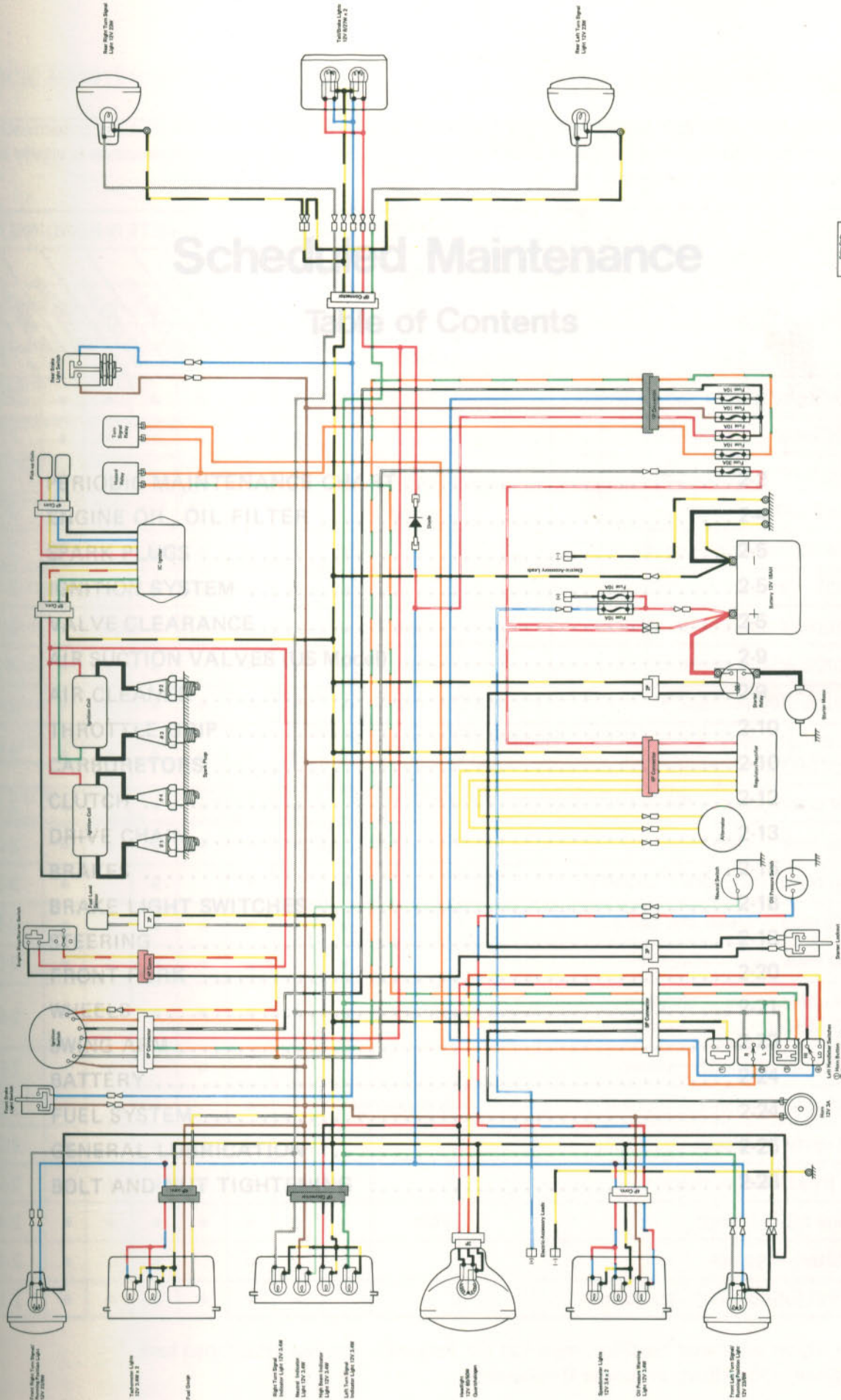

Front Right Turn Signal Light 12V 21/5W

Turn Signal Light 12V 21/5W x 2

Fuel Gauge

Right Turn Signal Indicator Light 12V 21/5W

Neutral Indicator Light 12V 21/5W

High Beam Indicator Light 12V 21/5W

Left Turn Signal Indicator Light 12V 21/5W

Headlight 12V 35/35W x 2

Indicator Light 12V 21/5W x 2

Oil Pressure Warning Light 12V 21/5W

Front Left Turn Signal Light 12V 21/5W

Legend:  
 (R) Main Battery  
 (G) Ground  
 (B) Ignition  
 (Y) Generator  
 (W) Accessory  
 (K) Kill Switch  
 (R) Right Turn Signal  
 (L) Left Turn Signal  
 (N) Neutral Indicator  
 (H) High Beam Indicator  
 (O) Oil Pressure Indicator  
 (F) Fuel Gauge  
 (I) Instrument Panel  
 (S) Stop Switch  
 (B) Brake Light  
 (H) Horn

Color Code

Red	B+
Green	Ground
Blue	Ignition
Yellow	Generator
White	Accessory
Black	Ground
Orange	Stop Switch
Purple	Horn
Brown	Brake Light
Grey	Instrument Panel

RIGHT HANDLEBAR SWITCH CONNECTIONS

Color	Function	Switch Position
Red	Ignition	ON
Green	Ground	ON
Blue	Ignition	OFF
Yellow	Generator	OFF
White	Accessory	OFF
Black	Ground	OFF

IGNITION SWITCH CONNECTIONS

Terminal	Color	Function
1	Red	Ignition
2	Green	Ground
3	Blue	Ignition
4	Yellow	Generator
5	White	Accessory
6	Black	Ground

LEFT HANDLEBAR SWITCH CONNECTIONS

Terminal	Color	Function
1	Red	Ignition
2	Green	Ground
3	Blue	Ignition
4	Yellow	Generator
5	White	Accessory
6	Black	Ground

LEFT HANDLEBAR SWITCH CONNECTIONS

Terminal	Color	Function
1	Red	Ignition
2	Green	Ground
3	Blue	Ignition
4	Yellow	Generator
5	White	Accessory
6	Black	Ground

Color Code

Red	B+
Green	Ground
Blue	Ignition
Yellow	Generator
White	Accessory
Black	Ground
Orange	Stop Switch
Purple	Horn
Brown	Brake Light
Grey	Instrument Panel

# Scheduled Maintenance

## Table of Contents

PERIODIC MAINTENANCE CHART	2-2
ENGINE OIL, OIL FILTER	2-4
SPARK PLUGS	2-5
IGNITION SYSTEM	2-5
VALVE CLEARANCE	2-5
AIR SUCTION VALVES (US Model)	2-9
AIR CLEANER	2-9
THROTTLE GRIP	2-10
CARBURETORS	2-10
CLUTCH	2-12
DRIVE CHAIN	2-13
BRAKES	2-15
BRAKE LIGHT SWITCHES	2-18
STEERING	2-18
FRONT FORK	2-20
WHEELS	2-21
SWING ARM	2-23
BATTERY	2-24
FUEL SYSTEM	2-24
GENERAL LUBRICATION	2-25
BOLT AND NUT TIGHTENING	2-28

\* For higher odometer readings, repeat at the frequency interval established here.  
 † Replace, add, adjust, or torque if necessary.

(Continued on next page)



## PERIODIC MAINTENANCE CHART

The maintenance and adjustments for the KZ/Z1000-J, K, and M must be done in accordance with this chart to keep the motorcycle in good running condition. **The initial maintenance is vitally important and must not be neglected.**

OPERATION	FREQUENCY	ODOMETER READING *								
		Every	800 km	5,000 km	10,000 km	15,000 km	20,000 km	25,000 km	30,000 km	See Page
Battery electrolyte level – check †	month	•	•	•	•	•	•	•	•	2-24
Brake wear – check †			•	•	•	•	•	•	•	2-15
Brake fluid level – check †	month	•	•	•	•	•	•	•	•	2-15
Brake fluid – change	year			•		•			•	2-16
Brake light switch – check †		•	•	•	•	•	•	•	•	2-18
Clutch – adjust		•	•	•	•	•	•	•	•	2-12
Carburetor operation – check †		•	•	•	•	•	•	•	•	2-10
Throttle grip – check †		•	•	•	•	•	•	•	•	2-10
Steering play – check †		•	•	•	•	•	•	•	•	2-18
Spoke tightness and rim runout – check † (KZ1000-M)		•	•	•	•	•	•	•	•	2-23
Drive chain wear – check †			•	•	•	•	•	•	•	2-14
Front fork – clean			•	•	•	•	•	•	•	2-20
Nuts, bolts, fasteners – check †		•		•		•			•	2-28
Spark plug – clean and gap †		•	•	•	•	•	•	•	•	2-5
Valve clearance – check †		•	•	•	•	•	•	•	•	2-5
Air suction valve – check † (US Model)			•	•	•	•	•	•	•	2-9
Air cleaner element – clean			•		•			•		2-9
Air cleaner element – replace	5 cleanings			•			•		•	2-9
Fuel system – clean				•		•			•	2-24
Tire tread wear – check †			•	•	•	•	•	•	•	2-21
Engine oil – change	year	•	•	•	•	•	•	•	•	2-4
Oil filter – replace		•		•		•			•	2-4
General lubrication – perform			•	•	•	•	•	•	•	2-25

\* For higher odometer readings, repeat at the frequency interval established here.

† Replace, add, adjust, or torque if necessary.

(Continued on next page.)

## PERIODIC MAINTENANCE CHART (Cont.)

OPERATION	FREQUENCY	ODOMETER READING *							See Page
		800 km	5,000 km	10,000 km	15,000 km	20,000 km	25,000 km	30,000 km	
Front fork oil – change	Every			•		•		•	2-20
Timing advancer – lubricate				•		•		•	2-5
Swing arm – lubricate				•		•		•	2-23
Wheel bearing – lubricate	2 years					•			2-22
Steering stem bearings – lubricate	2 years					•			2-20
Master cylinder cup and dust seal – replace	2 years								2-17
Caliper piston seal and dust seal – replace	2 years								2-17
Brake hose – replace	4 years								2-17
Fuel hose – replace	4 years								2-25
Drive chain – lubricate	Every 300 km								2-15
Drive chain slack – check †	Every 800 km								2-13

\* For higher odometer readings, repeat at the frequency interval established here.

† Replace, add, adjust, or torque if necessary.

**ENGINE OIL, OIL FILTER**

In order for the engine, transmission, and clutch to function properly, maintain the engine oil at the proper level, and change the oil and oil filter in accordance with the Periodic Maintenance Chart. Not only do dirt and metal particles collect in the oil, but the oil itself loses its lubricative quality if used too long.

**WARNING** 1. **Motorcycle operation with insufficient, deteriorated, or contaminated engine oil will cause accelerated wear and may result in engine or transmission seizure, accident, and injury.**

**Oil Level Inspection**

●If the oil has just been changed, start the engine and run it for several minutes at idle speed. This fills the oil filter with oil. Stop the engine, then wait several minutes until the oil settles.

**CAUTION** 1. **Racing the engine before the oil reaches every part can cause engine seizure.**

●If the motorcycle has just been used, wait several minutes for all the oil to drain down.  
 ●Check the engine oil level through the oil level gauge. With the motorcycle held level, the oil level should come up between the lines next to the gauge.

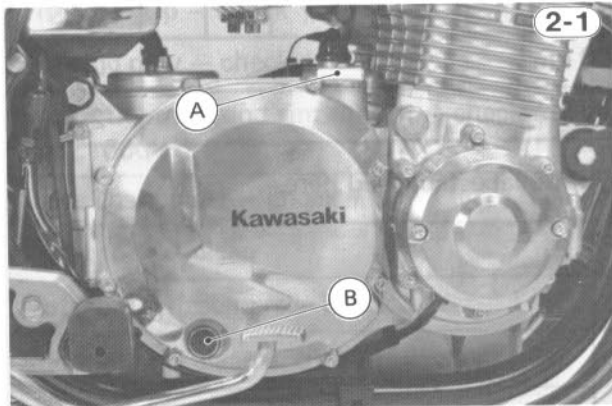

A. Oil Filler Opening Cap      B. Level Gauge

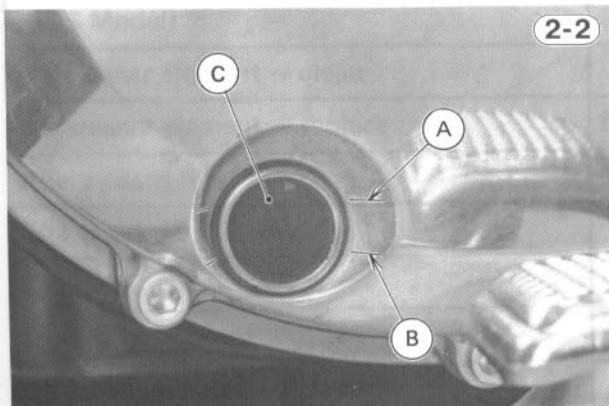

A. Upper Level      B. Lower Level      C. Level Gauge

★If the oil level is too high, remove the excess oil, using a syringe or some other suitable device.

★If the oil level is too low, add the correct amount of oil through the oil filler opening. Use the same type and make of oil that is already in the engine.

**CAUTION** 1. **If the engine oil gets extremely low or if the oil pump or oil passages clog up or otherwise do not function properly, the oil pressure warning light will light. If this light stays on when the engine speed is above 1,300 rpm, stop the engine immediately and find the cause.**

**Oil and/or Oil Filter Change**

- Warm up the engine throughly, and then stop the engine.
- Place an oil pan beneath the engine.
- Remove the engine drain plug.

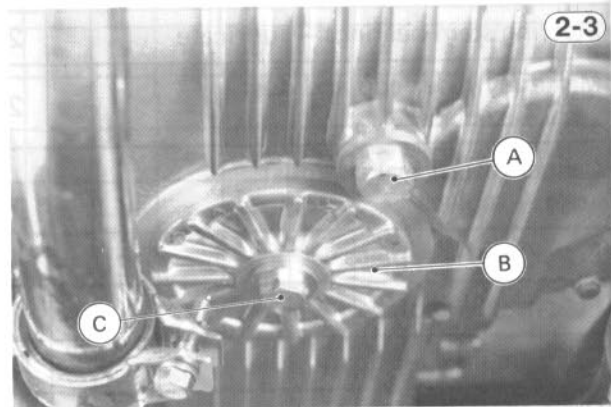

A. Drain Plug      C. Oil Filter Mounting Bolt  
 B. Oil Filter Cover

- With the motorcycle perpendicular to the ground, let the oil completely drain.
- If the oil filter is to be changed, replace it with a new one (Pg. 6-39).
- After the oil has completely drained out, install the engine drain plug with its gasket. Proper torque for the plug is shown in the table.

**NOTE:** 1. Replace the damaged gasket with a new one.

**Table 2-1 Tightening Torque**

Engine Drain Plug	3.0 kg-m (22 ft-lbs)
Oil Filter Mounting Bolt	2.0 kg-m (14.5 ft-lbs)

- Fill the engine up to the upper level with a good quality motor oil specified in the table.
- Check the oil level.

**Table 2-2 Engine Oil**

Grade	Viscosity	Filling Engine Oil Capacity	
		When filter is not changed	When filter is changed
SE Class	SAE 10W40	3.0 liters	3.7 liters
	10W50		
	20W40	3.0 liters	3.7 liters
	20W50		

1. I  
2. C

## SPARK PLUGS

Neglecting the spark plug eventually leads to difficult starting and poor performance. If the spark plug is used for a long period, the electrodes gradually burn away and carbon builds up along the inside part. In accordance with the Periodic Maintenance Chart, the plug should be removed for inspection, cleaning and to reset the gap.

### Cleaning and Gapping

- Remove the spark plugs.
- Clean the spark plugs preferably in a sand-blasting device, and then clean off any abrasive particles. The plug may also be cleaned using a high flash-point solvent and a wire brush or other suitable tool.
- Visually inspect the spark plug electrodes and insulator for any damage.
- ★ If the spark plug electrodes are corroded or damaged, or if the insulator is cracked, replace the plug. Use the standard plug or its equivalent.
- Measure the plug gap with a wire-type thickness gauge.
- ★ If the gap is incorrect, adjust the gap by bending the side electrode.

Table 2-3 Spark Plug

Standard Plug	NGK BR8ES or ND W24ESR-U, ① NGK B8ES or ND W24ES-U
Plug Gap	0.7 – 0.8 mm
Tightening Torque	2.8 kg-m (20 ft-lbs)

### Spark Plug

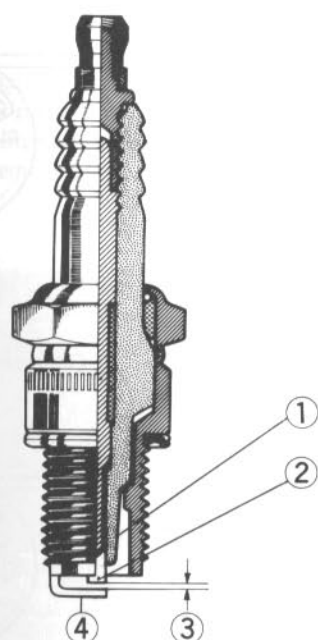

1. Insulator  
2. Center Electrode  
3. Plug Gap  
4. Side Electrode

## IGNITION SYSTEM

This motorcycle has a transistorized ignition system which has no moving parts in the electrical circuit. Consequently, there are no parts except an automatic timing advancer to require periodic maintenance. In accordance with the Periodic Maintenance Chart, the timing advancer should be lubricated as follows:

### Lubrication

- Remove the automatic timing advancer, and disassemble it.
- Wash each part with a high flash-point solvent, and dry them.
- Apply grease sparingly to the weight pivoting shafts and weight spring ends, and fill the groove in the timing rotor sleeve with grease.

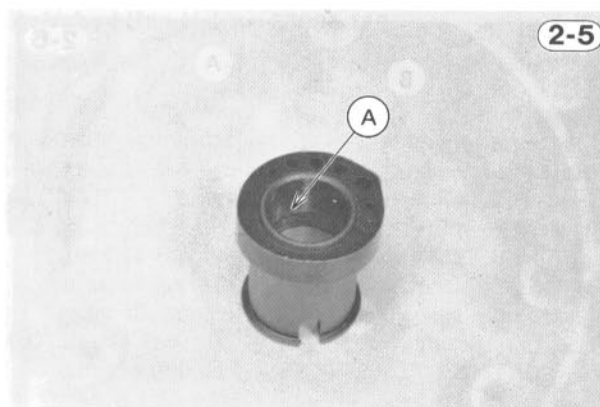

### A. Grease

- Assemble the timing advancer, and install it on the crankshaft.

## VALVE CLEARANCE

Valve and valve seat wear decreases valve clearance, upsetting valve timing.

**CAUTION** 1. If valve clearance is left unadjusted, the wear will eventually cause the valves to remain partly open; which lowers performance, burns the valve seats, and may cause serious engine damage.

Valve clearance for each valve should be checked and adjusted in accordance with the Periodic Maintenance Chart. When carrying out adjustment, be careful to adjust within the specified clearance. Adjusting to a larger value will both disturb valve timing and cause engine noise.

**NOTE:** 1. Valve clearance must be checked when the engine is cold (room or atmospheric temperature).

**Inspection**

- Open the seat, and disconnect the battery negative (-) lead.
- Remove the fuel tank.
- Remove the spark plugs.
- US model only: Remove the vacuum switch valve.
- Remove the cylinder head cover and its gasket.
- Remove the pickup coil cover.
- Using a 17 mm wrench on the crankshaft rotation nut, turn the crankshaft clockwise so that the "T" mark for the #1 and #4 pistons (1 4 "T" mark for short) on the timing advancer is aligned with the timing mark on the right engine cover.

**NOTE:** 1. In Fig. 2-6, the pickup coil assembly is removed for explanation. In actual procedure, pickup coil assembly removal is not necessary.

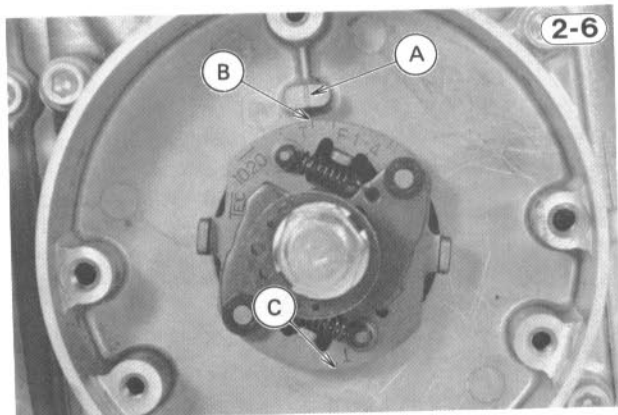

- A. Timing Mark
- B. "T" Mark for # 1 and # 4 Pistons
- C. "T" Mark for # 2 and # 3 Pistons

- Check that the "EX" mark (arrow adjoining letters "EX") on the exhaust camshaft sprocket is aligned with the cylinder head cover mating surface on the front side of the exhaust camshaft. If it is not, turn the crankshaft another turn until the "EX" mark is aligned with the crankcase mating surface again (Fig. 2-7).

- NOTE:** 1. At this position, the #1 (extreme left) piston is at top dead center (TDC) at the end of its compression stroke.
2. For valve clearance inspection, align the specified timing marks on the camshaft sprockets to position the camshafts.
- At this crankshaft position, measure the clearance between the cam and the shim of the #1 and #2 exhaust valves.

**Table 2-4 Valve Clearance (when engine cold)**

Inlet and Exhaust	0.05 - 0.15 mm
-------------------	----------------

**Valve Clearance Measurement**

1. #1 Piston TDC at End of Compression Stroke for #1 and #2 Exhaust Valves.

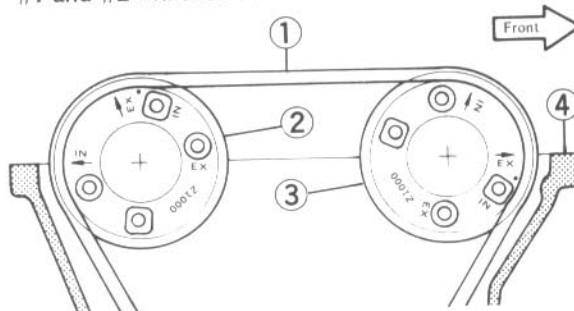

- 1. Camshaft Chain
- 2. Inlet Camshaft Sprocket
- 3. Exhaust Camshaft Sprocket
- 4. Cylinder Head

2. #2 Piston TDC at End of Compression Stroke for #1 and #2 Inlet Valves

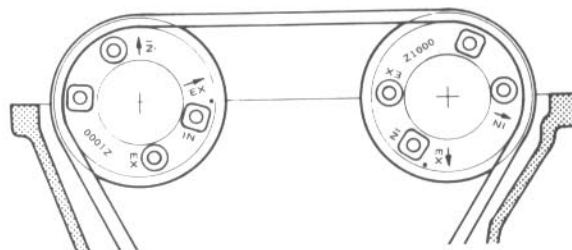

3. #4 Piston TDC at End of Compression Stroke for #3 and #4 Exhaust Valves

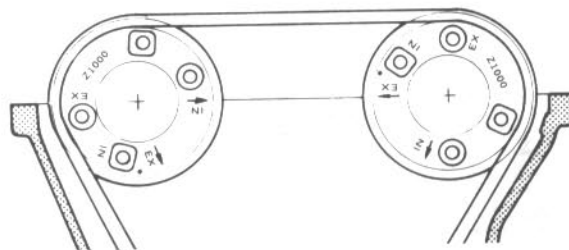

4. #3 Piston TDC at End of Compression Stroke for #3 and #4 Inlet Valves

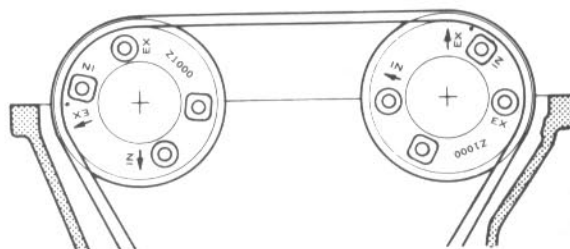

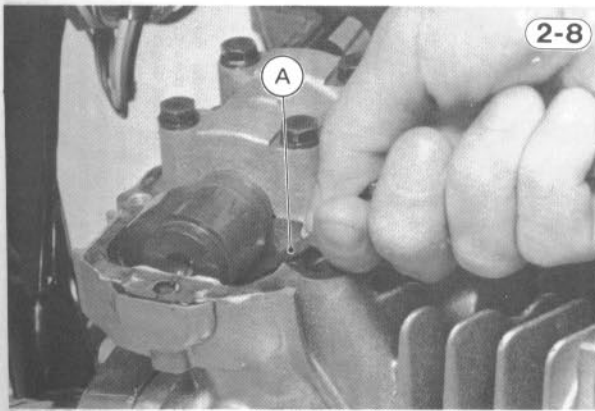

A. Thickness Gauge

- Next turn the crankshaft  $\frac{1}{2}$  turn clockwise, and align the punch mark on the inlet camshaft sprocket with the cylinder head cover mating surface on the front side of the inlet camshaft.
- At this crankshaft position, measure the valve clearance of the #1 and #2 inlet valves.
- Turn the crankshaft  $\frac{1}{2}$  turn clockwise, and align the "EX" mark on the exhaust camshaft sprocket with the mating surface on the rear side of the exhaust camshaft.
- At this crankshaft position, measure the valve clearance of the #3 and #4 exhaust valves.
- Turn the crankshaft  $\frac{1}{2}$  turn clockwise, and align the punch mark on the inlet camshaft sprocket with the mating surface on the rear side of the inlet camshaft.
- At this crankshaft position, measure the valve clearance of the #3 and #4 inlet valves.
- \*If the valve clearance is incorrect, continue the following procedure to replace the present shim with a new shim, which will give the proper clearance.

#### Adjustment

- Turn the crankshaft so that the cam points away from the lifter. Position the notch in the lifter so it points toward the opposite camshaft. This will allow the shim to be lifted and removed later.

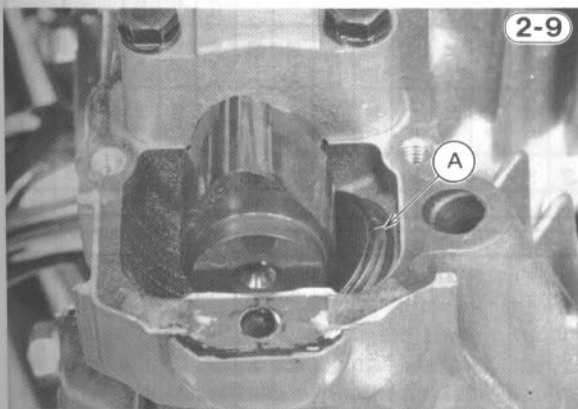

A. Notch

- Turn the crankshaft so that the cam is pushing the lifter down and fit the tool in place.

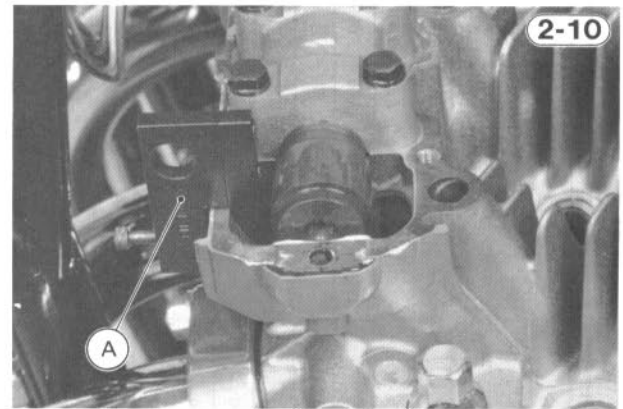

A. Valve Lifter Holder: 57001-113

- Turn the crankshaft in the proper direction so that the cam points away from the lifter, and remove the shim.

**CAUTION** 1. When the valve lifter holder is fitted to a valve assembly, and the crankshaft is turned to rotate the camshaft, it **MUST** be turned so the cam lobe turns away from the tool. If it is turned toward the tool, serious engine damage can result.

**NOTE:** 1. The camshaft rotates in the same direction as the crankshaft.

#### Valve Lifter Holder

2-11

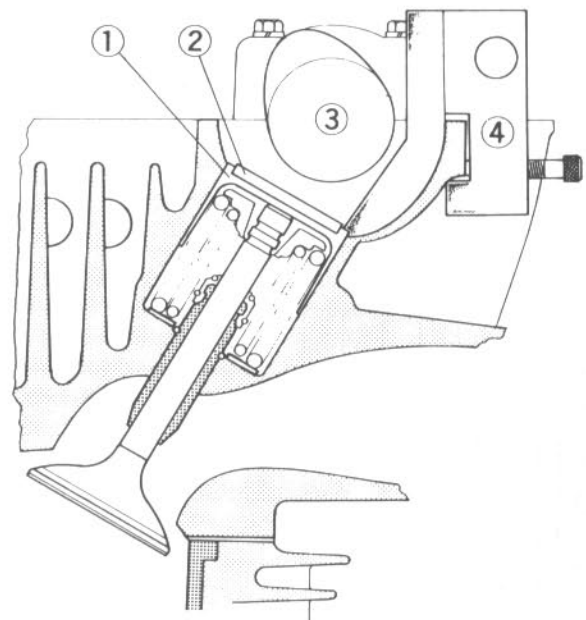

1. Valve Lifter  
2. Shim

3. Camshaft  
4. Valve Lifter Holder

Table 2-5 Valve Adjustment Chart (Both Inlet and Exhaust)

VALVE CLEARANCE (mm)	PRESENT SHIM SIZE																								
	001	002	003	004	005	006	007	008	009	010	011	012	013	014	015	016	017	018	019	020	021	022	023	024	025
0.00 - 0.02	2.00	2.05	2.10	2.15	2.20	2.25	2.30	2.35	2.40	2.45	2.50	2.55	2.60	2.65	2.70	2.75	2.80	2.85	2.90	2.95	3.00	3.05	3.10	3.15	3.20
0.03 - 0.04	2.00	2.05	2.10	2.15	2.20	2.25	2.30	2.35	2.40	2.45	2.50	2.55	2.60	2.65	2.70	2.75	2.80	2.85	2.90	2.95	3.00	3.05	3.10	3.15	3.20
0.05 - 0.15			2.00	2.05	2.10	2.15	2.20	2.25	2.30	2.35	2.40	2.45	2.50	2.55	2.60	2.65	2.70	2.75	2.80	2.85	2.90	2.95	3.00	3.05	3.10
0.16 - 0.17			2.10	2.15	2.20	2.25	2.30	2.35	2.40	2.45	2.50	2.55	2.60	2.65	2.70	2.75	2.80	2.85	2.90	2.95	3.00	3.05	3.10	3.15	3.20
0.18 - 0.22			2.20	2.25	2.30	2.35	2.40	2.45	2.50	2.55	2.60	2.65	2.70	2.75	2.80	2.85	2.90	2.95	3.00	3.05	3.10	3.15	3.20		
0.23 - 0.27			2.30	2.35	2.40	2.45	2.50	2.55	2.60	2.65	2.70	2.75	2.80	2.85	2.90	2.95	3.00	3.05	3.10	3.15	3.20				
0.28 - 0.32			2.40	2.45	2.50	2.55	2.60	2.65	2.70	2.75	2.80	2.85	2.90	2.95	3.00	3.05	3.10	3.15	3.20						
0.33 - 0.37			2.50	2.55	2.60	2.65	2.70	2.75	2.80	2.85	2.90	2.95	3.00	3.05	3.10	3.15	3.20								
0.38 - 0.42			2.60	2.65	2.70	2.75	2.80	2.85	2.90	2.95	3.00	3.05	3.10	3.15	3.20										
0.43 - 0.47			2.70	2.75	2.80	2.85	2.90	2.95	3.00	3.05	3.10	3.15	3.20												
0.48 - 0.52			2.80	2.85	2.90	2.95	3.00	3.05	3.10	3.15	3.20														
0.53 - 0.57			2.90	2.95	3.00	3.05	3.10	3.15	3.20																
0.58 - 0.62			3.00	3.05	3.10	3.15	3.20																		
0.63 - 0.67			3.10	3.15	3.20																				
0.68 - 0.72			3.20																						
0.73 - 0.77																									
0.78 - 0.82																									
0.83 - 0.87																									
0.88 - 0.92																									
0.93 - 0.97																									
0.98 - 1.02																									
1.03 - 1.07																									
1.08 - 1.12																									
1.13 - 1.17																									
1.18 - 1.22																									
1.23 - 1.27																									
1.28 - 1.35																									

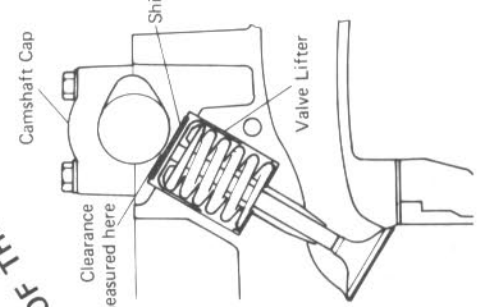

1. Align the mark on the camshaft sprocket with the cover mating surface, and measure the clearance (cold).
  2. Check present shim size.
  3. Match clearance in vertical column with present shim size in horizontal column.
  4. The shim specified where the lines intersect is the one that will give you the proper clearance.
- NOTE: 1. If there is no clearance between the shim and the cam, select a shim which is several sizes smaller and then remeasure the clearance.

**CAUTION**

1. Do not put shim stock under the shim. This may cause the shim to pop out at high rpm, causing extensive engine damage.
2. Do not grind the shim. This may cause it to fracture, causing extensive engine damage.
3. Check the valve clearance with the proper method in the text. Checking the clearance at any other cam position may result in improper valve clearance.

INSTALL THE SHIM OF THIS THICKNESS (mm)

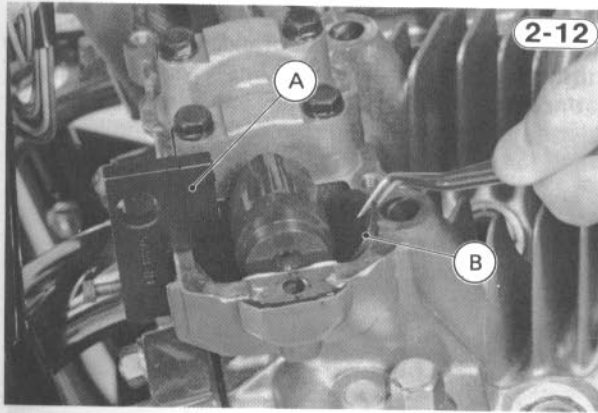

A. Valve Lifter Holder      B. Shim

- Check the present shim thickness (shim size) which is printed on the shim surface; and referring to the Valve Adjustment Chart (Pg. 2-8), select a new shim which brings valve clearance within the specified limits.

Shims are available in sizes from 2.00 to 3.20 mm, in increments of 0.05 mm.

**NOTE:** 1. If there is no clearance between the shim and cam, select a shim which is several sizes smaller and then remeasure the valve clearance once it is installed.

- Insert the new shim on the valve lifter with the numbered side facing downwards so the number won't be polished off by the action of the cam.

**CAUTION** 1. Do not put shim stock under the shim. This may cause the shim to pop out at high rpm, causing extensive engine damage.

2. Do not grind the shim. This may cause it to fracture, causing extensive engine damage.

**NOTE:** 1. If the smallest shim does not sufficiently increase clearance, the valve seat is probably worn. In this case, (a) repair the valve seat (Pg. 3-10), (b) grind down the valve stem slightly (Pg. 3-8), (c) then recheck the clearance.

- Turn the crankshaft so that the cam is again pushing down the lifter, and remove the special tool.

★ Make sure that the valve clearance is correct. If it is not, readjust.

- Adjust the clearance for the other valves in the same manner.

- Install the pickup coil cover.

- Install the cylinder head cover with a new gasket.

- US model only: Install the vacuum switch valve.

- Install the spark plugs.

- Install the fuel tank.

- Connect the battery negative (–) lead.

## AIR SUCTION VALVES (US Model)

The air suction valve is essentially a check valve which allows fresh air to flow only from the air cleaner into the exhaust port. Any air that has passed the air suction valve is prevented from returning. Inspect the air suction valves in accordance with the Periodic Maintenance Chart.

### Inspection

- Remove the fuel tank, and remove the air suction valves.
- Visually inspect the reeds for cracks, folds, warps, heat damage, or other damage.
- ★ If there is any doubt as to the condition of the reed contact areas, replace the air suction valve as an assembly.

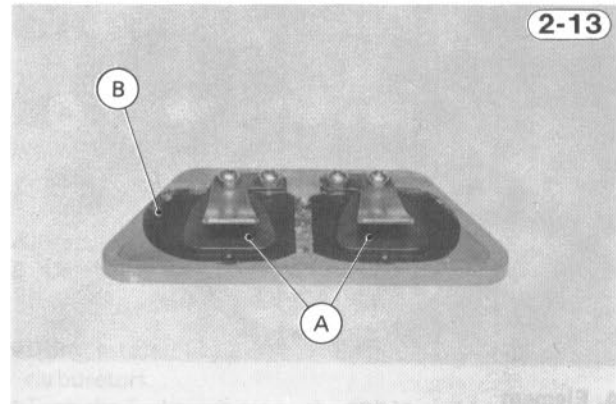

A. Reeds      B. Valve Holder

- Check the reed contact areas of the valve holder for grooves, scratches, any signs of separation from the holder, or heat damage.

★ If there is any doubt as to the condition of the reed contact areas, replace the air suction valve as an assembly.

★ If any carbon or other foreign particles have accumulated between the reed and the reed contact area, wash the valve assembly clean with a high flash-point solvent.

**CAUTION** 1. Do not scrape off the deposits with a scraper as this could damage the rubber, requiring replacement of the suction valve assembly.

- Install the air suction valves, and install the fuel tank.

## AIR CLEANER

A clogged air cleaner restricts the engine's air intake, increasing fuel consumption, reducing engine power, and causing spark plug fouling.

The air cleaner element must be cleaned and replaced in accordance with the Periodic Maintenance Chart. In dusty areas, the element should be cleaned more frequently than the recommended interval. After riding through rain or on muddy roads, the element should be cleaned immediately. The element should be replaced if it is damaged.

### Cleaning

- Remove the air cleaner element.
- Check the filter and sponge gasket of the element for damage.



- ★If the sponge gasket comes loose, stick it back on with an adhesive sealant.
- ★If the sponge or the filter is damaged, replace the element with a new one.
- Clean the element in a bath of a high flash-point solvent, and then dry it from the inside with compressed air.

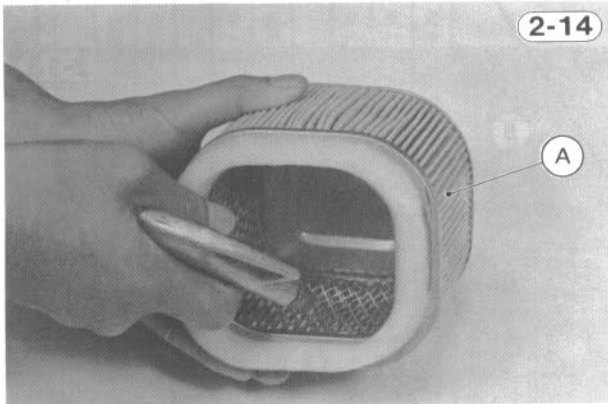

A. Element

**WARNING**

1. Clean the element in a well-ventilated area, and take ample care that there are no sparks or flame anywhere near the working area.
2. Because of the danger of highly flammable liquids, do not use gasoline or a low flash-point solvent to clean the element.

**CAUTION**

1. Since this is a dry-type element, do not use kerosene or any fluid which would leave the element oily.
- Install the element.

**Replacement**

Since repeated cleaning opens the pores of the element, replace it according to the Periodic Maintenance Chart. Refer to the "Disassembly" chapter for detailed removal and installation procedure.

---

**THROTTLE GRIP**

---

The throttle grip controls the throttle valves. If the throttle grip has excessive play due to either cable stretch or maladjustment, it will cause a delay in throttle response, especially at low engine speed. Also, the throttle valves may not open fully at full throttle. On the other hand, if the throttle grip has no play, the throttle will be hard to control, and the idle speed will be erratic. Check the throttle grip play periodically in accordance with the Periodic Maintenance Chart, and adjust the play if necessary.

**Inspection**

- Turn the throttle grip back and forth to check the throttle grip play.

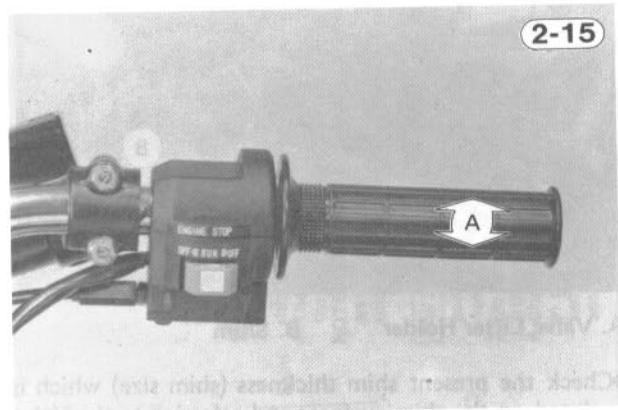

A. 2 – 3 mm

- ★There should be 2 – 3 mm play measured at the grip. If the cable does not have the proper play, adjust it as follows.

**Adjustment**

- Loosen the locknut at the upper end of the throttle cable, and turn the adjusting nut to adjust the play.

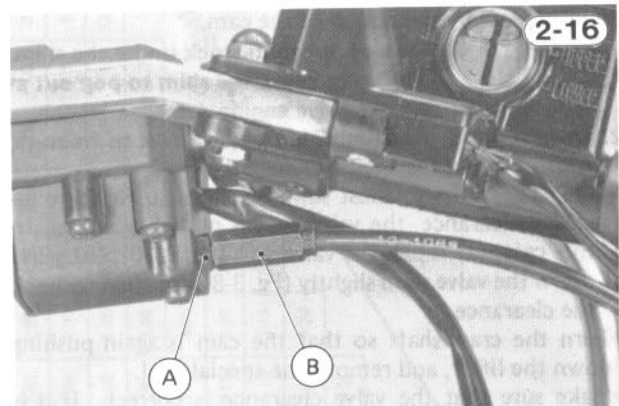

A. Locknut

B. Adjusting Nut

- Tighten the locknut.

---

**CARBURETORS**

---

The following procedure covers the carburetor adjustment, which should be performed in accordance with the Periodic Maintenance Chart or whenever the idle speed is disturbed.

When the idle speed is too low, the engine may stall; when the idle speed is too high, the fuel consumption becomes excessive, and the resulting lack of engine braking may make the motorcycle difficult to control. Poor carburetor synchronization will cause unstable idling, sluggish throttle response, and reduced engine power and performance.

### Idle Speed:

#### Inspection

- Thoroughly warm up the engine.
- Check that the idle speed is within the specified range.

Table 2-6 Idle Speed

1,000 ± 50 rpm
----------------

★ If the idle speed is out of the specified range, adjust it as follows.

#### Adjustment

- Turn the adjusting screw to adjust the idle speed.

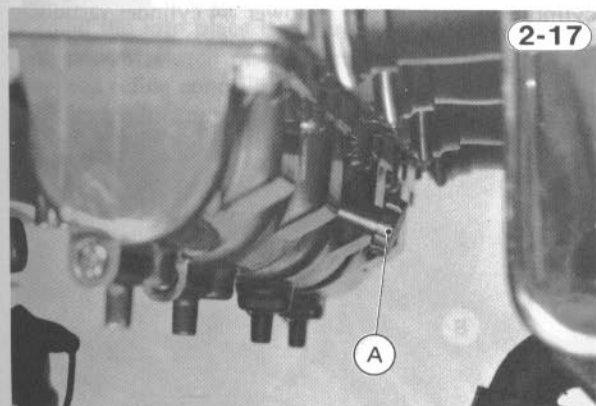

A. Adjusting Screw

- Open and close the throttle a few times to make sure that the idle speed is within the specified range. Re-adjust if necessary.
- With the engine idling, turn the handlebar to both sides. If handlebar movement changes the idle speed; the throttle cable may be improperly adjusted or incorrectly routed, or it may be damaged.

**WARNING** 1. Operation with improperly adjusted, incorrectly routed, or a damaged cable could result in an unsafe riding condition.

### Synchronization:

#### Inspection

- Warm up the engine thoroughly.
- Remove the fuel tank, and put it on the work bench near the motorcycle on the same level as the original position.
- US model: Pull off the three vacuum hoses (one for the fuel tap, two for the vacuum switch valve) and the rubber cap from the fittings on the carburetors.
- Other than US model: Pull off the vacuum hose (for the fuel tap) and the three rubber caps from the fittings on the carburetors.

- Attach the vacuum gauge (special tool) to the fittings.

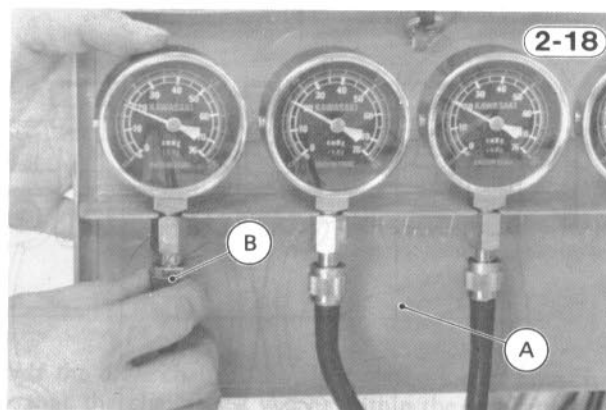

A. Vacuum Gauge Set: 57001-127

B. Damper Valve

- Using a suitable hose, connect the fuel tank with the carburetors.
- Turn the fuel tap lever to the "PRI" position.
- Start the engine, and let it idle.
- Adjust the damper valves so that the gauge needle flutter is less than 3 cm Hg.
- Adjust the idle speed.
- Note the gauge readings.

Table 2-7 Engine Vacuum

Difference between any two cylinders	Less than 2 cm Hg
--------------------------------------	-------------------

★ If the gauge shows more vacuum difference than specified in the table, synchronize the carburetors.

#### Adjustment

- To change the vacuum, loosen the locknut, and turn the balance adjusting screw.

**NOTE:** 1. First synchronize the left two or right two cylinders by means of the adjusting screw ① or ② between #1 and #2 cylinders, or #3 and #4 cylinders (Fig. 2-19). Then synchronize the left two cylinders and the right two cylinders using the center adjusting screw ③. Adjust the idle speed as necessary.

- If the idle speed has been changed during synchronization, adjust the idle speed again.
- Open the throttle grip and let it snap shut a few times. Make sure the vacuum readings stay within the specified vacuum reading.
- ★ If they do not, repeat the last three steps.
- After the carburetors are properly synchronized, tighten the locknuts without changing the positions of the screws.
- Detach the vacuum gauges, and install the vacuum hose(s) and the rubber cap(s) on the fittings on the carburetors.
- Install the fuel tank.

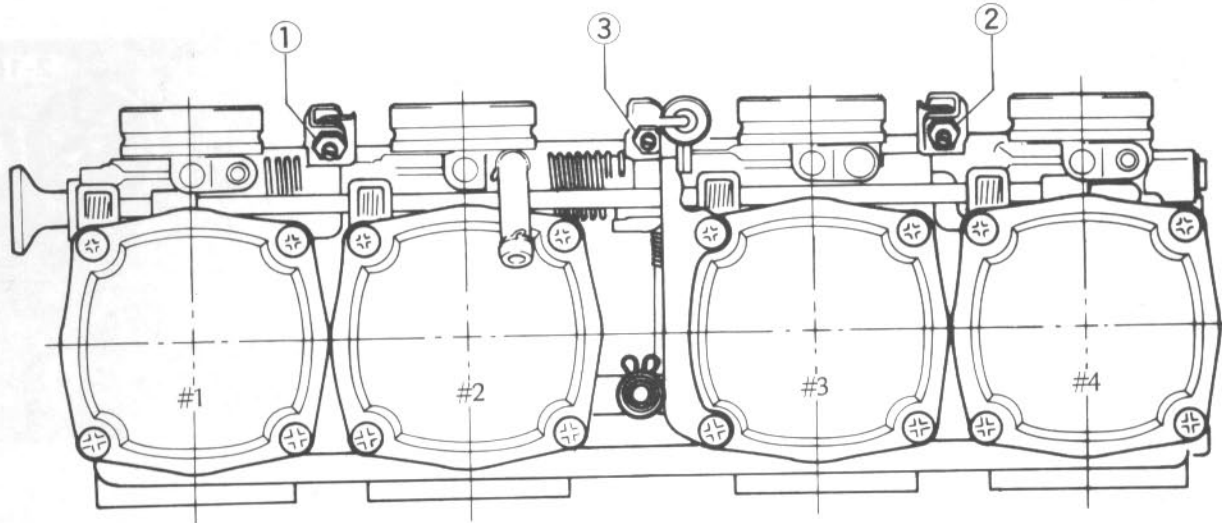

1. Left Adjusting Screw:  
Turn this screw clockwise to lower #1 cylinder vacuum.

3. Center Adjusting Screw:  
Turn this screw clockwise to lower #1 and #2 cylinder vacuum simultaneously.

2. Right Adjusting Screw:  
Turn this screw clockwise to lower #4 cylinder vacuum.

**CLUTCH**

Due to the friction plate wear and the clutch cable stretch over a long period of use, the clutch must be adjusted in accordance with the Periodic Maintenance Chart.

**WARNING** 1. To avoid a serious burn, never touch the hot engine or an exhaust pipe during clutch adjustment.

*Adjustment*

- Remove the clutch release adjusting cover.
- Loosen the locknuts, and turn in fully the clutch cable adjusters to give the cable plenty of play.

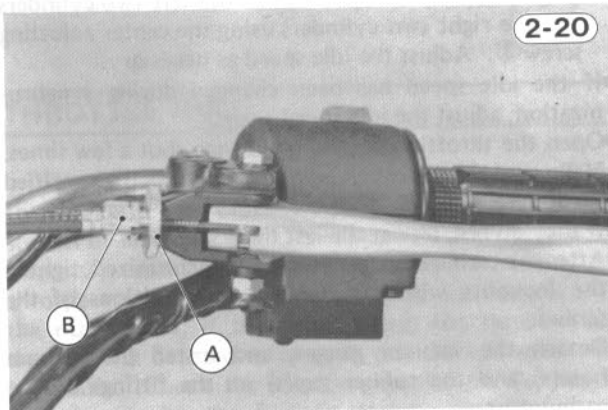

A. Locknut B. Cable Adjuster

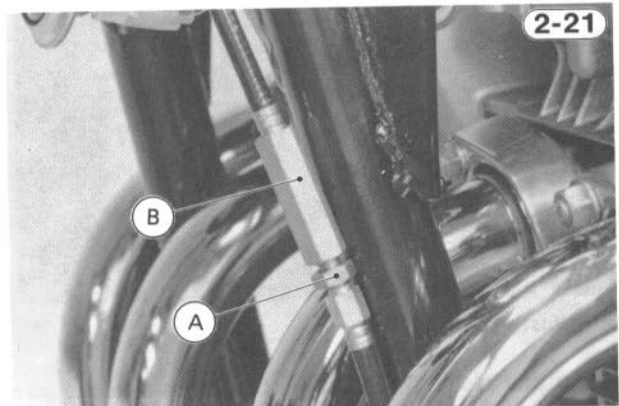

A. Locknut B. Cable Adjuster

- Loosen the locknut, and turn the clutch release adjusting screw clockwise until it becomes hard to turn.
- Turn the release adjusting screw counterclockwise 1/4 turn from that point, and tighten the locknut.

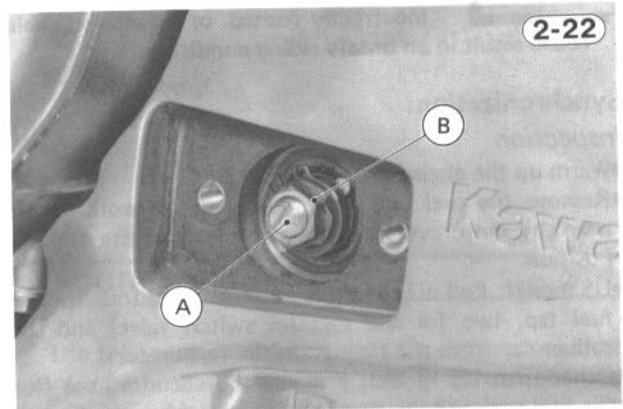

A. Release Adjusting Screw B. Locknut

- Turn the clutch cable adjusters so that the clutch lever will have 2 – 3 mm of play as shown in the figure.

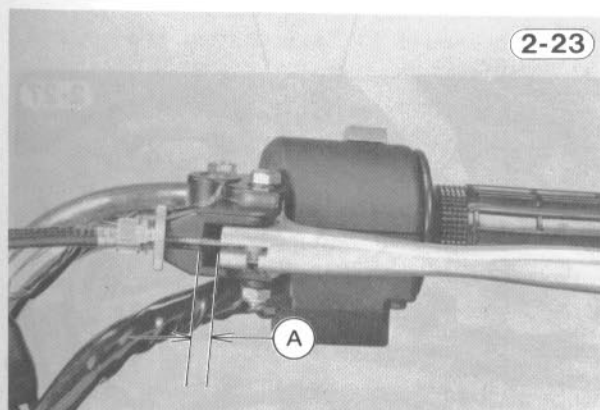

A. 2 – 3 mm

**WARNING** 1. Be sure each end of the clutch outer cable is fully seated in its fitting, or it could slip into place later, creating enough cable play to prevent clutch disengagement, resulting in a hazardous riding condition.

- Tighten the locknuts, and install the removed parts.
- After the adjustment is made, start the engine and check that the clutch does not slip and that it releases properly.

## DRIVE CHAIN

The drive chain must be checked, adjusted, and lubricated in accordance with the Periodic Maintenance Chart for safety and to prevent excessive wear. Lubrication is also necessary after riding through rain or on wet roads, or any time that the chain appears dry. If the chain becomes badly worn or maladjusted – either too loose or too tight – the chain could jump off the sprockets or break.

**NOTE:** 1. Observe the “CAUTION” for drive chain on Pg. 4-18.

**WARNING** 1. A chain that breaks or jumps off the sprockets could snag on the engine sprocket or lock the rear wheel, severely damaging the motorcycle and causing it to go out of control.

### Slack Inspection

- Set the motorcycle up on its center stand.
- Rotate the rear wheel to find the position where the chain is tightest, and measure the vertical movement midway between the sprockets.

## Chain Slack

2-24

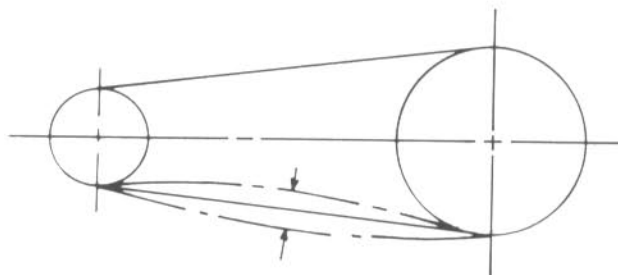

- ★ If the drive chain is too tight or too loose, adjust it so that the chain slack will be within the standard value.

Table 2-8 Drive Chain Slack

Standard	30 – 35 mm
Too tight or too loose	less than 30 mm or more than 40 mm

### Slack Adjustment

- Loosen the rear torque link nut.

**CAUTION** 1. Do not forget to loosen the torque link nut.

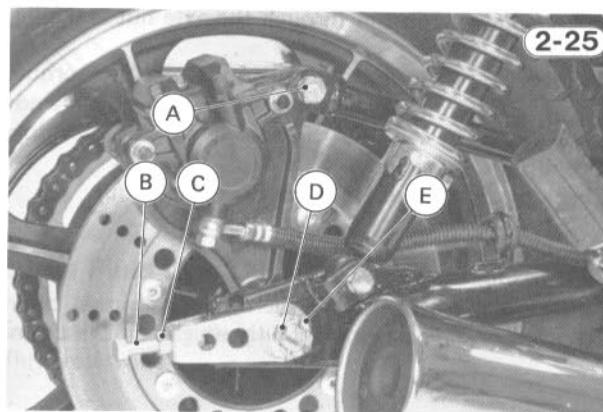

- A. Torque Link Nut      D. Cotter Pin  
B. Adjusting Bolt      E. Axle Nut  
C. Locknut

- Loosen the left and right chain adjuster locknuts.
- Remove the cotter pin, and loosen the axle nut.
- If the chain is too tight, back out the left and right chain adjusting bolts evenly, and kick the wheel forward until the chain is too loose.
- Turn both chain adjusting bolts evenly until the drive chain has the correct amount of slack. To keep the chain and wheel properly aligned, the notch on the left chain adjuster should align with the same swing arm mark that the right chain adjuster notch aligns with.

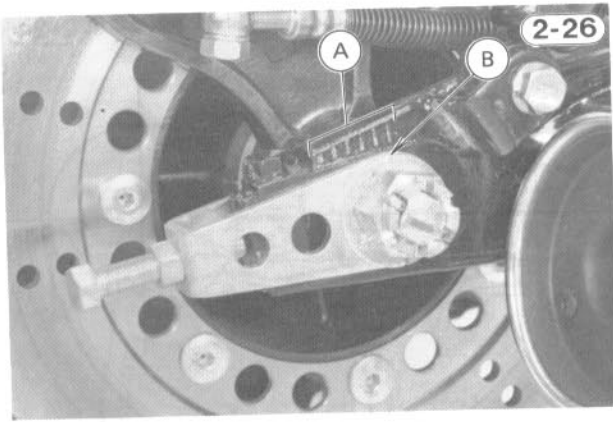

A. Swing Arm Marks      B. Notch

**NOTE:** 1. Wheel alignment can also be checked using the straightedge or string method.

**WARNING** 1. Misalignment of the wheel will result in abnormal wear, and may result in an unsafe riding condition.

- Tighten both chain adjusting bolt locknuts.
- Tighten the axle nut to the specified torque.

**Table 2-9 Tightening Torque**

Axle Nut	12.0 kg-m (87 ft-lbs)
Torque Link Nut	3.0 kg-m (22 ft-lbs)

- Rotate the wheel, measure the chain slack again at the tightest position, and readjust if necessary.
- Insert a new cotter pin through the axle nut and axle, and spread its ends.
- Tighten the rear torque link nut to the specified torque.

**WARNING** 1. If the axle and torque link nuts are not securely tightened, an unsafe riding condition may result.

- Check the rear brake. (See the Brakes section.)

**Wear Inspection**

- Stretch the chain taut either by using the chain adjusters, or by hanging a 10 kg weight on the chain.

**Drive Chain**

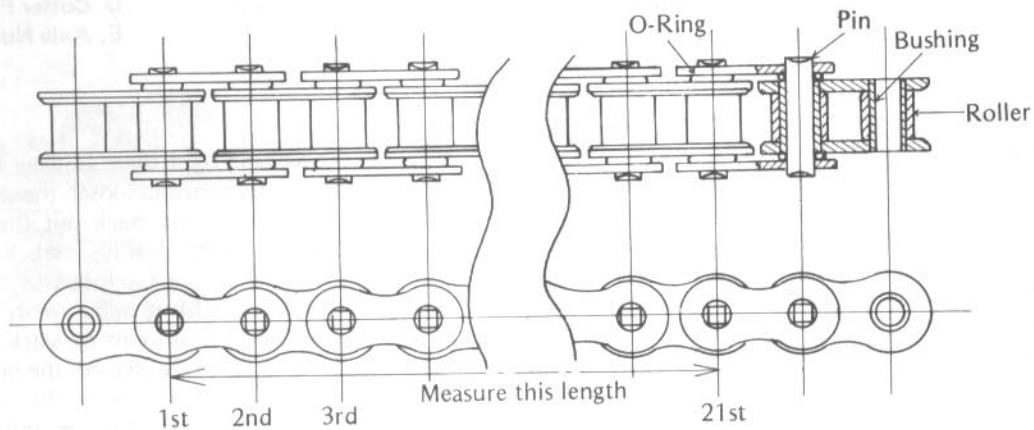

- Measure the length of 20 links on a straight part of the chain from pin center of the 1st pin to pin center of the 21st pin. Since the chain may wear unevenly, take measurements at several places.

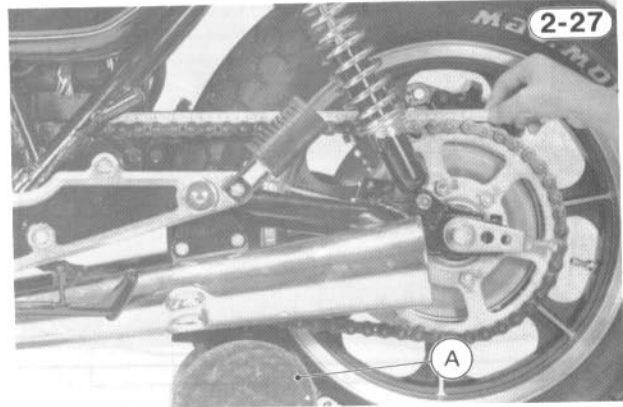

A. Weight

- ★ If any measurements exceeds the service limit, replace the chain. Also replace the engine and rear sprockets when the drive chain is replaced.

**WARNING** 1. For safety, use only the standard chain. It is an endless type and should not be cut for installation.

**Table 2-10 Drive Chain 20-Link Length**

Standard	Service Limit
381.0 – 381.8 mm	389 mm

- Rotate the rear wheel to inspect the drive chain for damaged rollers, and loose pins and links.
- Also inspect the sprockets for unevenly or excessively worn teeth, and damaged teeth.

**NOTE:** 1. Sprocket wear is exaggerated for illustration.  
 ★ If there is any irregularity, replace the drive chain and both sprockets.

**Sprocket Teeth**

2-29

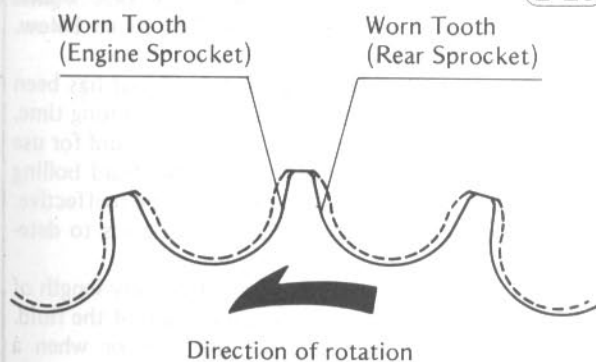
**Lubrication**

The chain should be lubricated with a lubricant which will both prevent the exterior from rusting and also absorb shock and reduce friction in the interior of the chain. An effective, good quality lubricant specially formulated for chains is best for regular chain lubrication. If a special lubricant is not available, a heavy oil such as SAE 90 is preferred to a lighter oil because it will stay on the chain longer and provide better lubrication.

- Apply oil to the sides of the rollers so that oil will penetrate to the rollers and bushings. Apply the oil to the O-rings so that the O-rings will be coated with oil.
- Wipe off any excess oil.

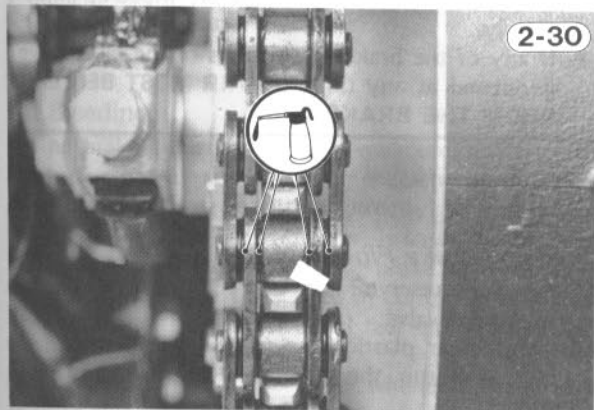
**BRAKES****Brake Adjustment:**

Disc and disc pad wear is automatically compensated for and has no effect on the brake lever and pedal action. So there are no parts that require periodic adjustment on the front and rear brakes.

**WARNING** 1. If the brake lever or pedal has a soft or "spongy feeling" when it is applied, there might be air in the brake lines or the brake may be defective. Since it is dangerous to operate the motorcycle under such conditions, bleed the air from the brake line immediately.

**Brake Wear:**

In accordance with the Periodic Maintenance Chart, inspect the front and rear brakes for wear.

**Inspection**

- Check the lining thickness of the pads in each caliper.
- ★If the lining thickness of either pad is less than the service limit, replace both pads in the caliper as a set.

**Table 2-11 Pad Lining Thickness**

	Standard	Service Limit
Front	3.5 mm	1 mm
Rear	5 mm	1 mm

**Brake Pad**

2-31

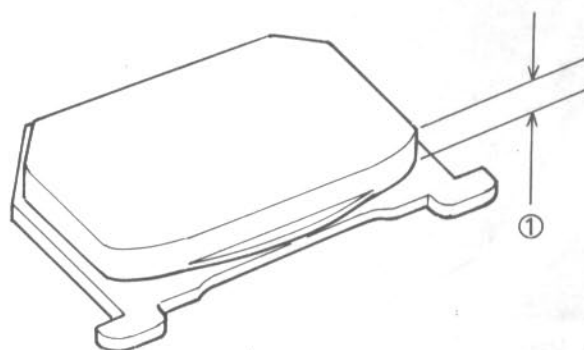

1. Lining Thickness

**Brake Fluid Level:**

In accordance with the Periodic Maintenance Chart, inspect the brake fluid level in the front and rear brake fluid reservoirs.

**Inspection**

- Check the brake fluid level in the reservoir.
- NOTE:** 1. Hold the reservoir horizontal when checking brake fluid level.
- ★The fluid level should be between the upper and lower level lines. If the fluid level is lower than the lower level line, fill the reservoir to the upper level line with the same type and brand of fluid that already is in the reservoir.
- NOTE:** 1. See the next paragraph for brake fluid requirement.

**WARNING** 1. Change the brake fluid in the brake line completely if the brake fluid must be refilled but the type and brand of the brake fluid that already is in the reservoir are unidentified. After changing the fluid, use only the same type and brand

of fluid thereafter. Mixing different types and brands of brake fluid lowers the brake fluid boiling point and could cause the brake to be ineffective. It may also cause the rubber brake parts to deteriorate.

#### Front Brake Fluid Reservoir

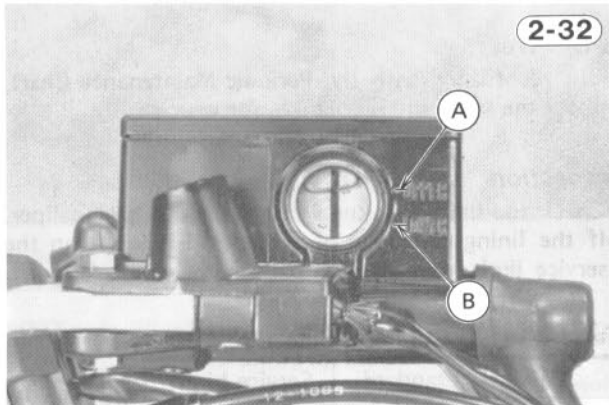

A. Upper Level Line      B. Lower Level Line

#### Rear Brake Fluid Reservoir

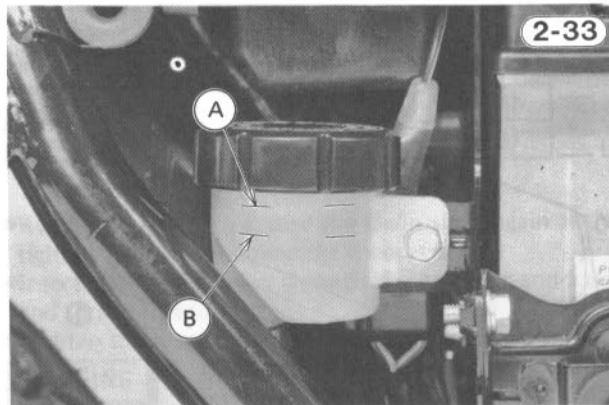

A. Upper Level Line      B. Lower Level Line

#### Brake Fluid Change:

In accordance with the Periodic Maintenance Chart, change the brake fluid. The brake fluid should also be changed if it becomes contaminated with dirt or water.

#### Brake Fluid Requirement:

Recommended fluids are given in the table below. If none of the recommended brake fluids are available, use extra heavy-duty brake fluid only from a container marked D.O.T.3.

Table 2-12 Recommended Disc Brake Fluid

Type	Brand
D.O.T.3	Atlas Extra Heavy Duty
	Shell Super Heavy Duty
	Texaco Super Heavy Duty
	Wagner Lockheed Heavy Duty
	Castrol Girling-Universal
	Castrol GT (LMA)
	Castrol Disc Brake Fluid

**WARNING** When working with the disc brake, observe the precautions listed below.

1. Never reuse old brake fluid.
2. Do not use fluid from a container that has been left unsealed or that has been open for a long time.
3. Do not mix two types and brands of fluid for use in the brake. This lowers the brake fluid boiling point and could cause the brake to be ineffective. It may also cause the rubber brake parts to deteriorate.
4. Don't leave the reservoir cap off for any length of time to avoid moisture contamination of the fluid.
5. Don't change the fluid in the rain or when a strong wind is blowing.
6. Except for the disc pads and discs, use only disc brake fluid, isopropyl alcohol, or ethyl alcohol for cleaning brake parts. Do not use any other fluid for cleaning these parts. Gasoline, motor oil, or any other petroleum distillate will cause deterioration of the rubber parts. Oil spilled on any part will be difficult to wash off completely and will eventually reach and break down the rubber used in the disc brake.
7. When handling the disc pads or disc, be careful that no disc brake fluid or any oil gets on them. Clean off any fluid or oil that inadvertently gets on the pads or disc with a high flash-point solvent. Do not use one which will leave an oily residue. Replace the pads with new ones if they cannot be cleaned satisfactorily.
8. Brake fluid quickly ruins painted surfaces; any spilled fluid should be completely wiped up immediately.
9. If any of the brake line fittings or the bleed valve is opened at any time, the **AIR MUST BE BLED FROM THE BRAKE.**

#### Changing Brake Fluid

- Remove the reservoir cap, and remove the rubber cap on the bleed valve.
  - Attach a clear plastic hose to the bleed valve on the caliper, and run the other end of the hose into a container.
  - Open the bleed valve (counterclockwise to open), and pump the brake lever or pedal until all the fluid is drained from the line.
  - Close the bleed valve.
  - Front brake: Since a dual disc brake is used, repeat the above 4 steps one more time for the other side.
  - Fill the reservoir with fresh brake fluid.
  - Open the bleed valve, apply the brake by the brake lever or pedal, close the valve with the brake held applied, and then quickly release the lever or pedal. Repeat this operation until the brake line is filled and fluid starts coming out of the plastic hose.
- NOTE:** 1. Replenish the fluid in the reservoir as often as necessary to keep it from running completely out.
- Front brake: Repeat the above 2 steps one more time for the other side.
  - Bleed the air from the lines.

## Filling up Brake Line

2-34

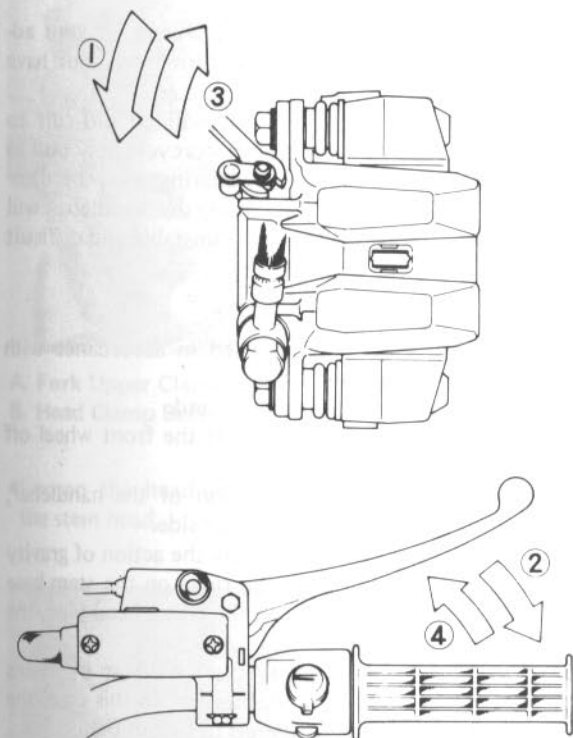

1. Open the bleed valve.
2. Apply the brake, keeping the brake applied.
3. Close the bleed valve.
4. Then quickly release the brake.

## Air Bleeding:

The brake fluid has a very low compression coefficient so that almost all the movement of the brake lever or pedal is transmitted directly to the caliper for braking action. Air, however, is easily compressed. When air enters the brake lines, brake lever or pedal movement will be partially used in compressing the air. This will make the lever or pedal feel spongy, and there will be a loss in braking power.

Bleed the air from the brake whenever brake lever or pedal action feels soft or spongy, after the brake fluid is changed, or whenever a brake line fitting has been loosened for any reason.

- Remove the reservoir cap, and check that there is plenty of fluid in the reservoir.
- With the reservoir cap installed, slowly pump the brake lever or pedal several times until no air bubbles can be seen rising up through the fluid from the holes at the bottom of the reservoir. This bleeds the air from the master cylinder end of the line.
- Connect a clear plastic hose to the bleed valve at the caliper, running the other end of the hose into a container. Pump the brake lever or pedal a few times until it becomes hard and then, holding the lever squeezed or the pedal pushed down, quickly open (turn counterclockwise) and close the bleed valve. Then release the lever or pedal. Repeat this operation until no more air can be seen coming out into the plastic hose.

## Bleeding Brake Line

2-35

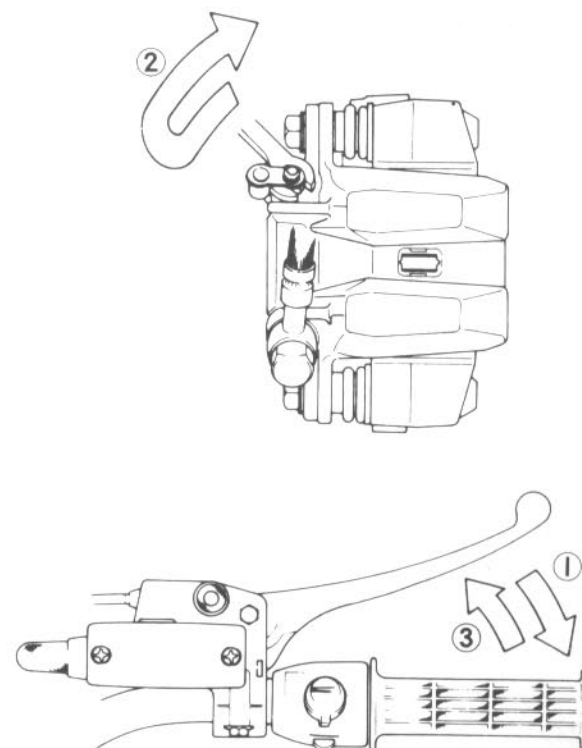

1. Hold the brake applied.
2. Quickly open and close the valve.
3. Release the brake.

- Tighten the bleed valve to 0.80 kg-m (69 in-lbs) of torque.

**NOTE:** 1. The fluid level must be checked several times during the bleeding operation and replenished as necessary. If the fluid in the reservoir runs completely out any time during bleeding, the bleeding operation must be done over again from the beginning since air will have entered the line.

- Front brake: Since a dual disc brake is used, repeat the above four steps one more time for the other side.
- When air bleeding is finished, install the rubber cap(s) on the bleed valve, and check that the brake fluid is filled to the upper level line marked in the reservoir (handlebar turned so that the reservoir is level).
- Apply the brake forcefully for a few seconds, and check for fluid leakage around the fittings.

## Rubber Disc Brake Parts:

In accordance with the Periodic Maintenance Chart, replace the brake hoses, caliper and master cylinder rubber parts. The removal and installation, disassembly and assembly sequences which need a special care is explained in the "Disassembly" Chapter.



## BRAKE LIGHT SWITCHES

When either the front or rear brake is applied, the brake light goes on. The front brake light switch requires no adjustment, but the rear brake light switch should be adjusted in accordance with the Periodic Maintenance Chart.

### Inspection

- Turn on the ignition switch.
- The brake light should go on when the front brake is applied.
- ★ If it does not, inspect the brake light circuit.
- Check the operation of the rear brake light switch by depressing the brake pedal. The brake light should go on after about 15 mm of pedal travel.

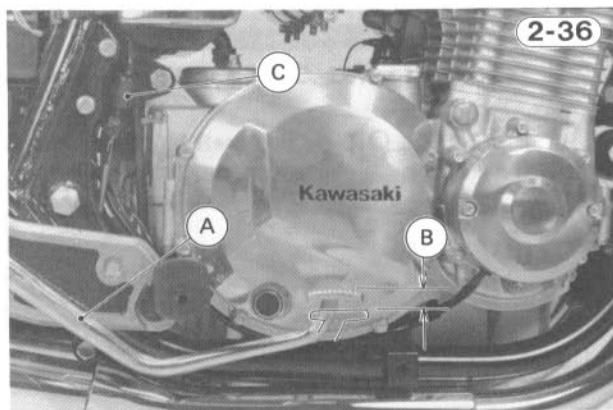

A. Brake Pedal                      C. Brake Light Switch  
B. 15 mm

- ★ If it does not, adjust the rear brake light switch.

### Adjustment

- Adjust the rear brake light switch by moving the switch up or down. To change the switch position, turn the adjusting nut.

**CAUTION** 1. To avoid damaging the electrical connections inside the switch, be sure that the switch body does not turn during adjustment.

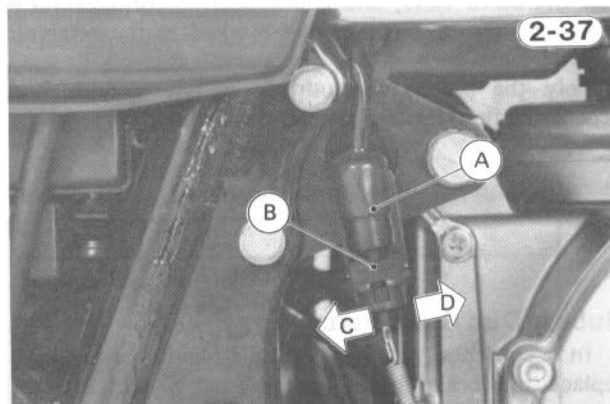

A. Rear Brake Light Switch                      C. Lights sooner.  
B. Adjusting Nut                                      D. Lights later.

## STEERING

For safety, the steering should always be kept adjusted so that the handlebar will turn freely but have no play.

If the steering is too tight; it will be difficult to turn the handlebar quickly, the motorcycle may pull to one side, and the steering stem bearings may be damaged. If the steering is too loose, the handlebar will vibrate and the motorcycle will be unstable and difficult to steer in a straight line.

### Inspection

The steering should be checked in accordance with the Periodic Maintenance Chart.

- Set the motorcycle on its center stand.
- Using a jack under the engine, lift the front wheel off the ground.
- From the straightforward position of the handlebar, slowly push the handlebar to either side.
- ★ If the handlebar begins to turn by the action of gravity and continues moving until the ridge on the stem base stops against the stop plate on the frame head pipe, the steering is not too tight.

**NOTE:** 1. The handlebar may catch halfway by means of the cables and wiring harnesses. In this case, the steering couldn't be considered to be too tight.

- ★ If the handlebar does not begin to turn by the action of gravity, the steering is too tight necessitating adjustment.

- Squat in front of the motorcycle and grasp the lower ends of the front fork. Push and pull the fork end back and forth.

- ★ If play is felt, the steering is too loose, necessitating adjustment.

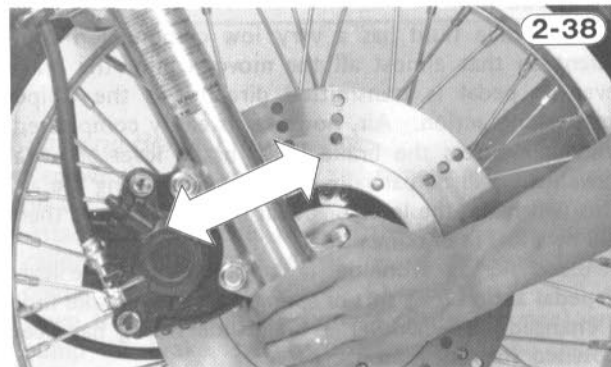

### Adjustment

Proper steering adjustment is completed by finding out the correct position of the lower stem locknut and by tightening the stem head bolt to the specified torque.

- Remove the fuel tank to avoid damaging the painted surface.
- Remove the screws, and take off the handlebar clamp cover.
- Remove the handlebar clamp bolts and lockwashers (4 ea), remove the clamp cover bracket and handlebar clamps, and put the handlebar aside from the steering stem head.
- Loosen the front fork upper clamp bolts (2) and stem head clamp bolt.
- Remove the steering stem head bolt and washer.

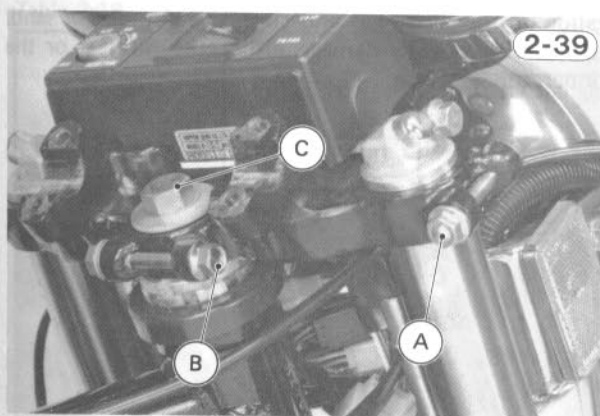

A. Fork Upper Clamp Bolt      C. Head Bolt  
B. Head Clamp Bolt

- Loosen the headlight bracket mounting bolts (2) on the stem head.

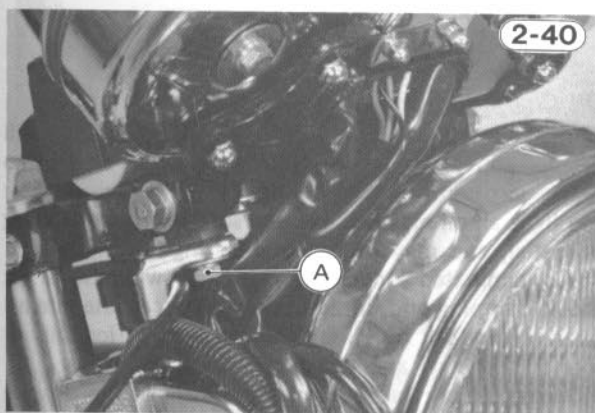

A. Headlight Bracket Mounting Bolts

- Tap lightly on the bottom of the stem head with a mallet, and lift the stem head slightly to loosen the upper steering stem locknut.
- Loosen the upper stem locknut all the way with the stem nut wrench (special tool).

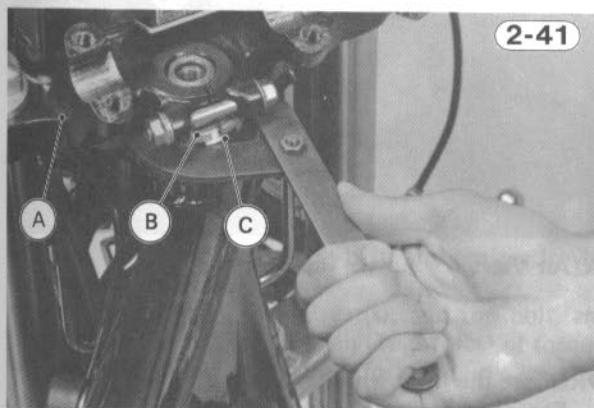

A. Stem Head      C. Lower Stem Locknut  
B. Upper Stem Locknut

- NOTE:** 1. The following four steps should be performed on only first adjustment after steering bearing installation. This procedure settle the bearings in place.
- Using the stem locknut wrench, tighten the lower stem locknut to 4.0 kg-m (29 ft-lbs) of torque. To tighten the steering stem locknut to the specified torque, hook the wrench on the stem locknut, and pull the wrench at the hole by 22.2 kg force in the direction shown in Fig. 2-42.

#### Torquing Stem Locknut

2-42

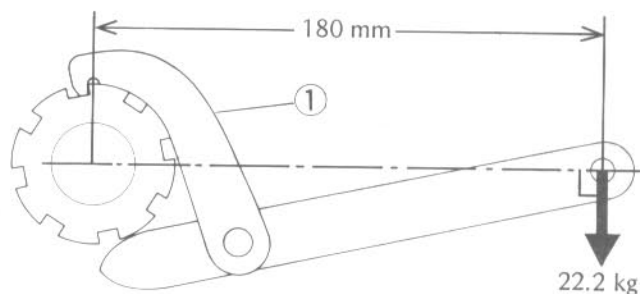

- Stem Nut Wrench: 57001-1100

- Check that there is no play and the steering stem turns smoothly without the rattle. If not, the steering stem bearing may be damaged.
- Again back out the lower steering stem locknut a fraction of a turn until it turns lightly.
- Turn the lower steering stem locknut lightly clockwise until it just becomes hard to turn. Do not over-tighten, or the steering will be too tight.

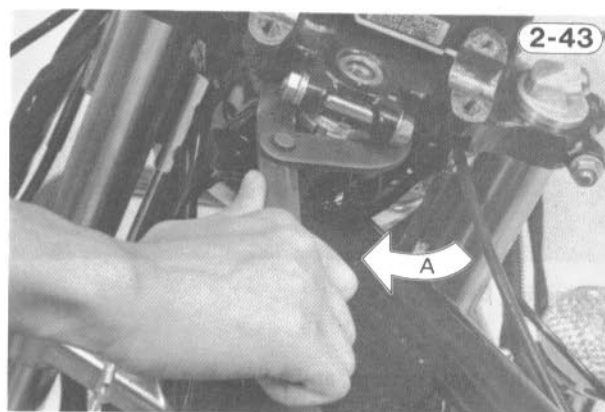

A. Turn lightly.

- If the steering is too tight, loosen the lower stem locknut a fraction of turn; if the steering is too loose, tighten the locknut a fraction of turn. Turn the locknut a 1/8 turn at maximum at a time.
- Keeping the lower stem locknut at the position with another wrench (92110-1036), tighten the upper stem locknut lightly.

- Tighten the steering stem head bolt to 4.3 kg-m (31 ft-lbs) of torque.
- Tighten the steering stem head clamp bolt to 1.8 kg-m (13.0 ft-lbs) of torque.
- Tighten the front fork upper clamp bolts (2) to 1.8 kg-m (13.0 ft-lbs) of torque.
- Temporarily install the handlebar on the stem head, and check the steering again.
- ★ If the steering is still too tight or too loose, repeat the adjustment.
- Install the handlebar correctly and install the removed parts.
- Remount the fuel tank.

### Lubrication

In accordance with the Periodic Maintenance Chart, the steering stem bearings should be relubricated.

- Remove the steering stem.
- Using a high flash-point solvent, wash the upper and lower tapered roller bearings in the cages, and wipe the upper and lower outer races, which are press-fitted into the frame head pipe, clean of grease and dirt.
- Visually check the outer races and the rollers.
- ★ Replace the bearing assembly if they show wear or damage.
- Pack the upper and lower tapered roller bearings in the cages with grease, and apply light coat of grease to the upper and lower outer races.

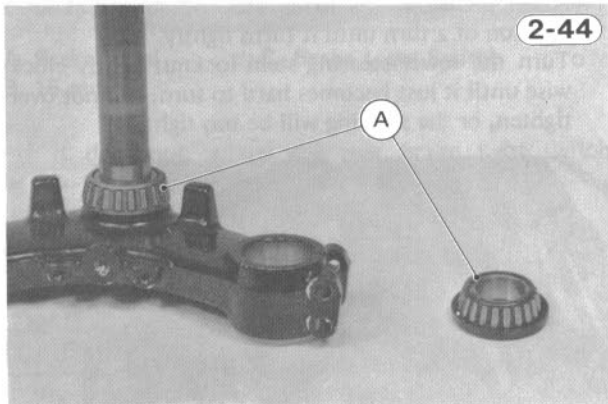

A. Steering Bearings

- Install the steering stem, and adjust the steering.

## FRONT FORK

### Cleaning

Dirt or sand that has worked its way past a dust seal will eventually damage the oil seal, causing oil leakage. In accordance with the Periodic Maintenance Chart, clean dirt or sand that has accumulated in the dust seals.

- Slide up the dust seals and clean out any dirt or sand. Be careful not to damage either the oil seal or the inner tube surface.

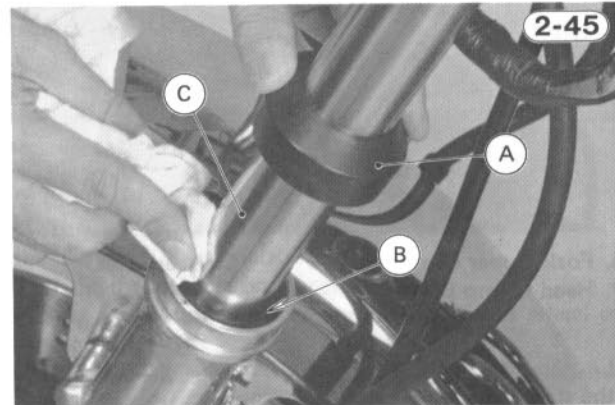

A. Dust Seal

B. Oil Seal

C. Inner Tube

### Oil Change

Either too much or too little oil in the fork legs will adversely affect shock damping. Too much oil or too heavy an oil makes the action too stiff; too little oil or too light an oil makes the action soft, decreases damping potential, and may cause noise during fork movement.

Contaminated or deteriorated oil will also affect shock damping and, in addition, will accelerate internal wear. The fork oil should be changed periodically or sooner if the oil appears dirty.

- Release the air in both fork legs through the air valve at the top of the fork leg, and loosen both top bolts before fork leg removal.

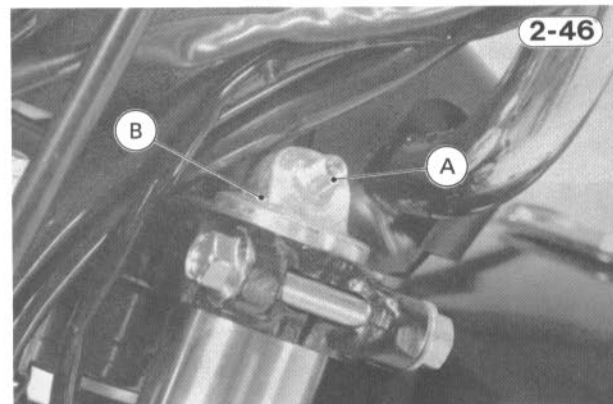

A. Air Valve

B. Top Bolt

- Remove the front wheel and both fork legs.  
For each fork leg, repeat the following procedure:
- Unscrew the drain screw and top bolt, and pull out the fork spring(s) and spring seat(s).

Table 2-13 Fork Oil

Model	Oil Type	Filling Fork Oil Capacity		Oil Level*
		When Changing Oil	After Disassembly and Completely Dry	
KZ/Z1000-J	SAE 10W20	about 300 cc	327 ± 4 cc	110 ± 2 mm
KZ/Z1000-K, KZ1000-M	SAE 10W20	about 320 cc	351 ± 4 cc	184 ± 2 mm

\*Distance from the top of the inner tube, measured with the fork tube fully compressed and with the main spring(s) removed.

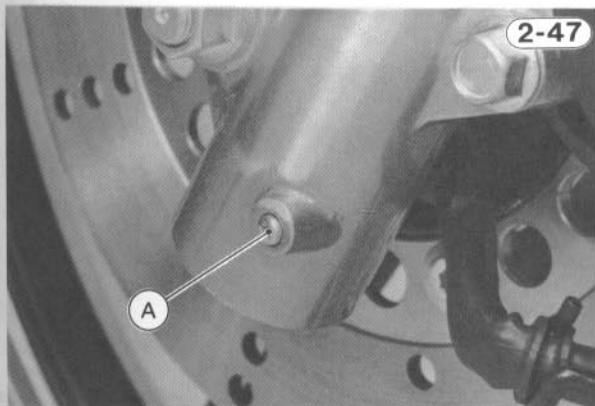

2-47

A. Drain Screw

- Pour the oil into the suitable container, pumping as necessary to empty out all the oil.
- Wash the drain screw threads clean of oil, and blow them dry.
- Apply a liquid gasket to the thread of drain screw, and install the screw and gasket.
- Pour in the type and amount of oil specified in Table 2-13.
- Pump the fork enough times to expel the air from the upper and lower chambers.
- With the fork leg fully compressed and held upright, insert a tape measure or rod in the inner tube, and measure the distance from the top of the inner tube to the oil.

★ If the oil is above or below the specified level, remove or add oil and recheck the oil level.

**CAUTION** 1. The operation of air front forks is especially dependent upon correct oil level. Higher level than specified may cause oil leakage and seal breakage. So be sure to maintain the specified level.

- Inspect the O-ring on the top bolt, and replace it with a new one if it is damaged.
- Install the spring(s), spring seat(s), and top bolt, and tighten the top bolt to 2.3 kg-m (16.5 ft-lbs) of torque.
- Change the oil of the other fork leg in the same manner.
- Install the front fork legs and front wheel.
- Adjust the air pressure in each fork leg (Pg. 4-14).

## Oil Level Measurement

2-48

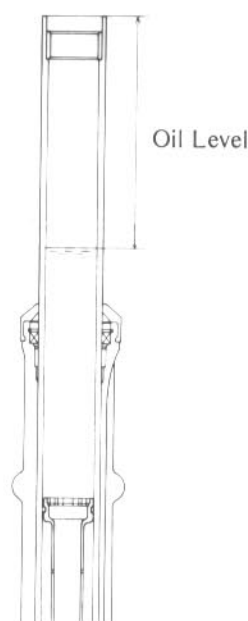

---

## WHEELS

---

### Tires:

#### Tire Wear, Damage

As the tire tread wears down, the tire becomes more susceptible the puncture and failure. An accepted estimate is that 90% of all tire failures occur during the last 10% of tread life (90% worn). So it is false economy and unsafe to use the tires until they are bald.

## 2-22

In accordance with the Periodic Maintenance Chart, check the tire for wear.

- Measure the depth of the tread with a depth gauge. Since the tire may wear unevenly, take measurements at several places.
- ★ If any measurement is less than the service limit, replace the tire.

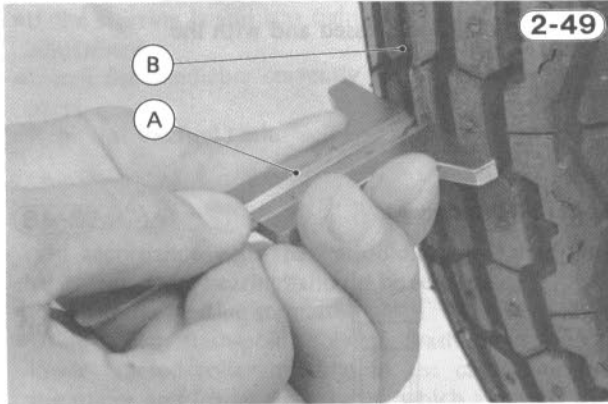

A. Depth Gauge

B. Tread

Table 2-14 Tire Tread Depth

Tire	Service Limit	
	Under 130 kph	Over 130 kph
Front	1 mm	1 mm
Rear	2 mm	3 mm

- Visually inspect the tire for cracks and cuts, replacing the tire in case of bad damage. Swelling or high spots indicate internal damage, requiring tire replacement.
- Remove any imbedded stones or other foreign particles from the tread.

**NOTE:** 1. Check and balance the wheels when required, or when a tire is replaced with a new one.  
2. Tires and rims specially designed for tubeless use have the indications of "TUBELESS" on the tire side wall and the rim spoke.

- WARNING** 1. To ensure safe handling and stability, use only the recommended standard tires for replacement, inflated to the standard pressure.  
2. For front and rear wheels of a motorcycle, use the tires of the same maker.

Table 2-15 Standard Tire

	KZ/Z1000-J	KZ1000-K US, Canadian Models	Z1000-K other than US, Canadian Models	KZ1000-M
Front	3.25V-19 4PR TUBELESS BRIDGESTONE L303A	3.25H-19 4PR TUBELESS BS L303AW, or DUNLOP F8	3.25V-19 4PR TUBELESS DUNLOP F11	3.25H-19 4PR TUBE TYPE DUNLOP F11
Rear	4.25V-18 4PR TUBELESS BRIDGESTONE G506	130/90-16 67H TUBELESS BS G504BW, or DUNLOP K427	130/90V-16 4PR TUBELESS DUNLOP K427	130/90-16 67H TUBE TYPE DUNLOP K427

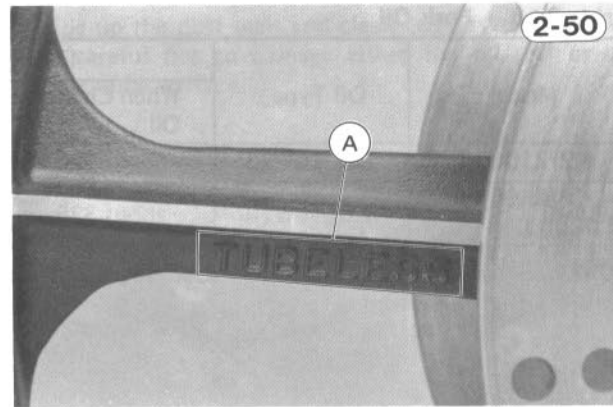

A. TUBELESS



A. TUBELESS

### Wheel Bearings:

#### Lubrication

Since worn wheel bearings will cause play in the wheel, vibration, and instability, they should be cleaned, inspected, and greased in accordance with the Periodic Maintenance Chart.

- Remove the front wheel and the rear wheel coupling, and remove the two front wheel bearings and one rear wheel coupling bearing.

**NOTE:** 1. The two rear wheel bearings are packed with grease, and shielded. Bearing removal is not required for lubrication.

- Wash the bearing with a high flash-point solvent, dry it (do not spin it while it is dry), and oil it.

- Spin it by hand to check its condition.
- ★ If it is noisy, does not spin smoothly, or has any rough spots, it must be replaced.
- If the same bearing is to be used again, re-wash it with a high flash-point solvent, and dry it.
- Pack it with good quality bearing grease before installation. Turn the bearing around by hand a few times to make sure the grease is distributed uniformly inside the bearing, and wipe the old grease out of the hub before bearing installation.



- Replace the grease seals, which are removed for bearing removal, with new ones. The seals are generally damaged upon removal.

### Spoke and Rim (KZ1000-M):

The spokes and rims of the wire-spoke wheels on the KZ1000-M must be inspected as follows in accordance with the Periodic Maintenance Chart. Since the spokes must withstand repeated stress, it is important to take sufficient care that the spokes are not allowed to loosen and that they are tightened evenly. Loose or unevenly tightened spokes cause the rim to warp, increase the possibility of spoke breakage, and hasten nipple and spoke metal fatigue.

#### Spoke Tightness

- Check that all the spokes are tightened evenly since they stretch a certain amount during use.
- ★ Standard spoke tightening torque is 0.20 – 0.40 kg-m (17 – 35 in-lbs). Over- or under-tightening may cause breakage.

#### WARNING

1. If any spoke breaks, it should be replaced immediately. A missing spoke places an additional load on the other spokes, which will eventually cause other spokes to break.

#### Rim Runout

- Set a dial gauge against the side of the rim, and rotate the wheel to measure axial runout. The difference between the highest and lowest dial readings is the amount of runout.

- Set the dial gauge to the inner circumference of the rim, and rotate the wheel to measure radial runout. The difference between the highest and lowest dial readings is the amount of runout.

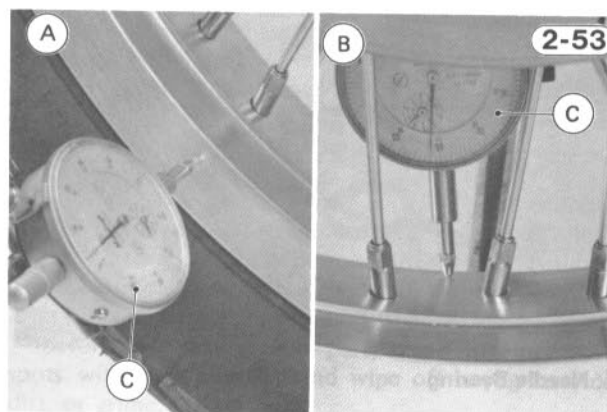

A. Axial Runout      C. Dial Gauge  
B. Radial Runout

Table 2-16 Rim Runout (with tire installed)

	Service Limit
Axial and Radial	2 mm

- ★ If rim runout exceeds the service limit, correct the rim warp (runout). A certain amount of rim warp can be corrected by recentering the rim. Loosen some spokes and tighten others to change the position of different parts of the rim. If the rim is badly bent, however, it should be replaced.

## SWING ARM

In order for the swing arm to function safely and wear slowly, it should be lubricated in accordance with the Periodic Maintenance Chart.

#### Lubrication

- Remove the swing arm, and pull the swing arm sleeves out of the pivot.
- NOTE:** 1. The distance collar can be left in the swing arm pivot for swing arm lubrication.
- Using a high flash-point solvent, wash the sleeves and the needle bearings clean of grease, and dry them.
- Inspect the needle bearings, sleeves, and grease seals for abrasions, color change, or other damage.
- ★ If there is any doubt as to the condition of any needle bearing or sleeve, replace all the needle bearings and sleeves. Replace the damaged grease seal with a new one.

- Pack the needle bearings with a molybdenum disulfide chassis assembly grease, and apply same grease to the outer circumference of the sleeves.

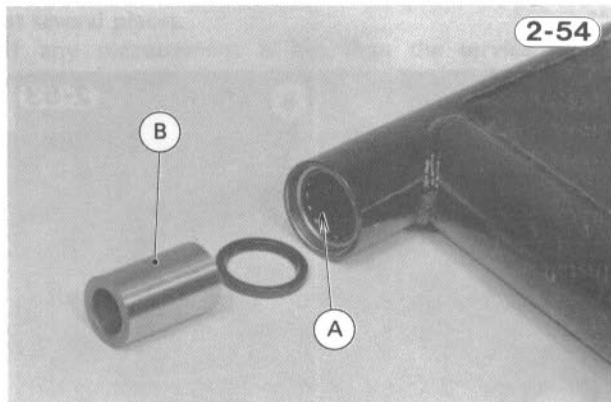

A. Needle Bearing      B. Sleeve

- Install the swing arm.

## BATTERY

### Battery Electrolyte Level Inspection

The battery electrolyte level must be kept between the upper and lower level lines. Check the electrolyte level in each cell in accordance with the Periodic Maintenance Chart.

- Remove the battery.
- Check that the electrolyte level in the each cell is between the upper and lower level lines.

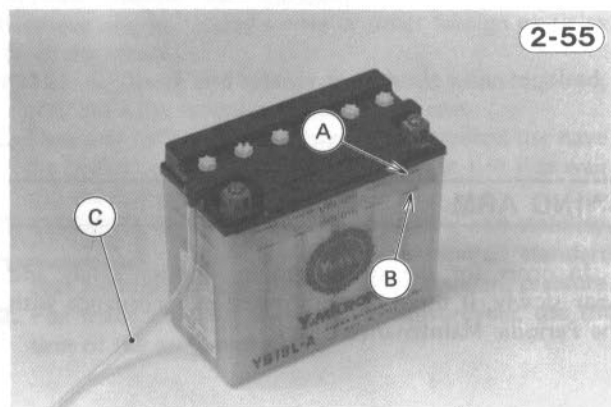

A. Upper Level Line      C. Vent Hose  
B. Lower Level Line

- ★If the electrolyte level is low in the cell, fill with distilled water as follows.
- Remove the battery filler caps and fill with distilled water until the electrolyte level in each cell reaches the upper level line.

### CAUTION

1. Add only distilled water to the battery. Ordinary tap water is not a substitute for distilled water and will shorten the life of the battery.

- Install the battery observing the "CAUTION" label for battery vent hose routing.

## FUEL SYSTEM

Accumulation of moisture or sediment in the fuel system will restrict the flow of fuel and cause carburetor malfunction. The system should be checked in accordance with the Periodic Maintenance Chart.

### WARNING

1. Inspect the fuel system in a well-ventilated area, and take ample care that there are no sparks or flame anywhere near the working area.
2. Never inspect the fuel system when the engine is still warm.
3. Wipe any fuel off the engine before starting it.

### Inspection and Cleaning

- Connect a suitable hose to the fitting at the bottom of each carburetor float bowl.
- Run the lower ends of the hoses into a suitable container.
- Turn the fuel tap lever to the "PRI" position.
- Turn out each drain plug a few turns to drain the carburetors, and check to see if water or dirt has accumulated in the carburetors. Continue draining each carburetor for about 10 seconds.

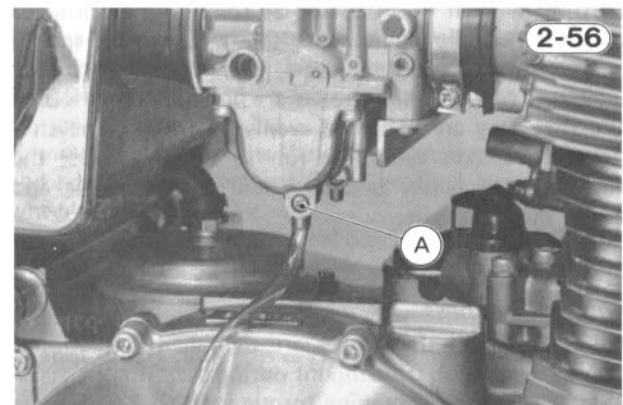

A. Drain Plug

- Tighten the drain plug, and turn the fuel tap lever to the "ON" position.
- ★If any water or dirt appeared during the above inspection, clean the fuel system as follows.
- Remove the fuel tank, and remove the fuel tap from the tank.
- Flash out the fuel tank with a high flash-point solvent.
- Wash the fuel filter on the fuel tap clean of dirt with a high flash-point solvent.
- Remove the carburetors, and disassemble them to clean the fuel and air passages.

**CAUTION**

1. Remove the diaphragm and float before cleaning the carburetor with compressed air, or they will be damaged.
  2. Remove as many rubber or plastic parts from the carburetors as possible before cleaning the carburetors with a cleaning solution. This will prevent damage or deterioration of the parts.
  3. The carburetor body has plastic parts that cannot be removed. **DO NOT** use a strong carburetor cleaning solution which could attack these parts; instead, use a mild cleaning solution safe for plastic parts.
  4. Do not use wire for cleaning as this could damage the jets.
- Wash the disassembled parts, and air and fuel passages with a high flash-point solvent then blow them clean with compressed air. If necessary, use a bath of automotive type carburetor cleaner.

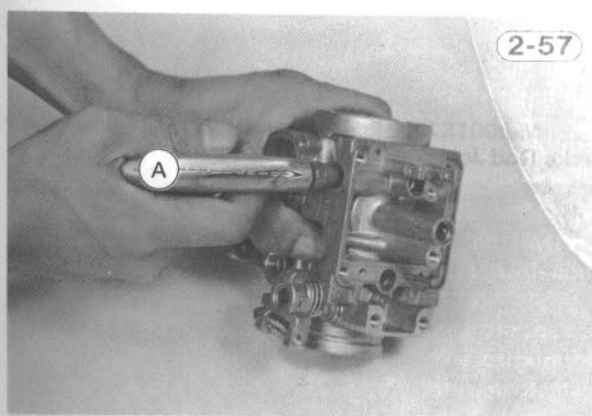

A. Blow passages clean.

- Assemble and install the carburetors.
- Install the fuel tap on the fuel tank, and install the fuel tank.

**Fuel Hose Replacement**

In accordance with the Periodic Maintenance Chart, replace the fuel hose with a new one.

- Remove the fuel tank.
- Replace the fuel hose which connects the fuel tap with the carburetors. Also replace the hose clamps with new ones.

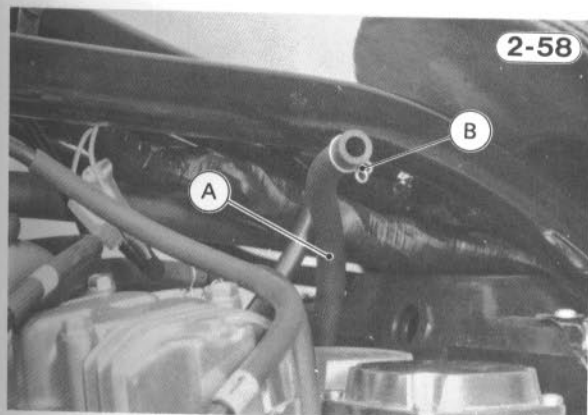

A. Fuel Hose

B. Clamps

- Install the fuel tank, and check for fuel leakage.

**GENERAL LUBRICATION**

Lubricate the points shown here, with either motor oil or regular grease, in accordance with the Periodic Maintenance Chart or whenever the vehicle has been operated under wet or rainy conditions, and especially after using a highpressure spray washer.

Before lubricating each part, clean off any rusty spots with rust remover and wipe off any grease, oil, dirt, or grime.

**NOTE:** 1. A few drops of oil are effective to keep bolts and nuts from rusting and sticking. This makes removal easier. Badly rusted nuts, bolts etc., should be replaced with new ones.

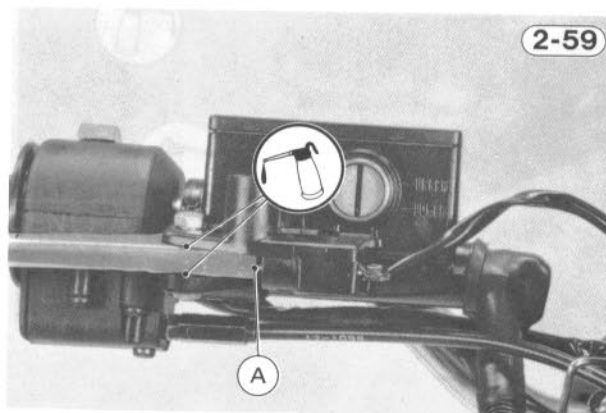
**Brake Lever**

A. Grease.

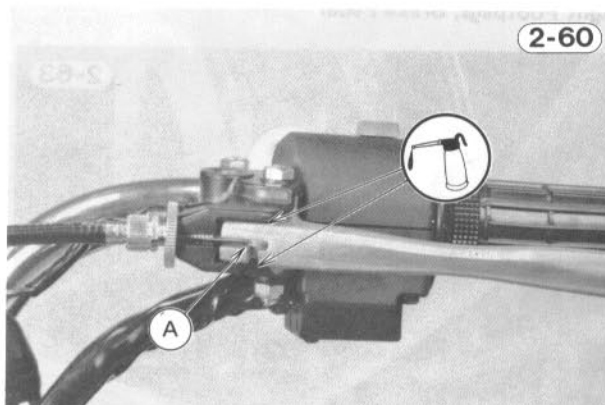
**Clutch Lever**

A. Grease.



Center Stand

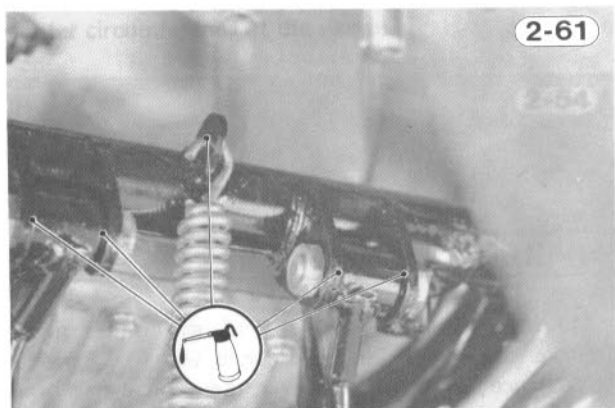

Rear Footpegs

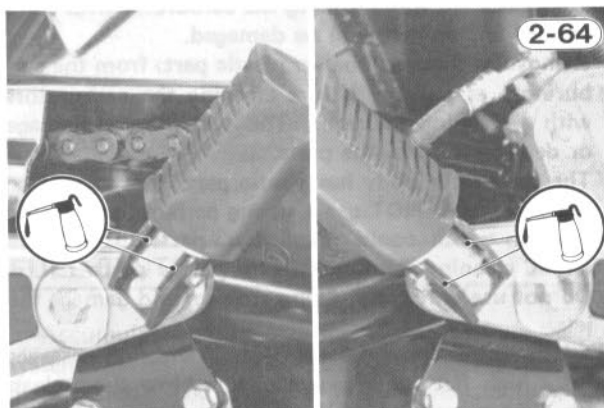

Left Footpegs, Side Stand

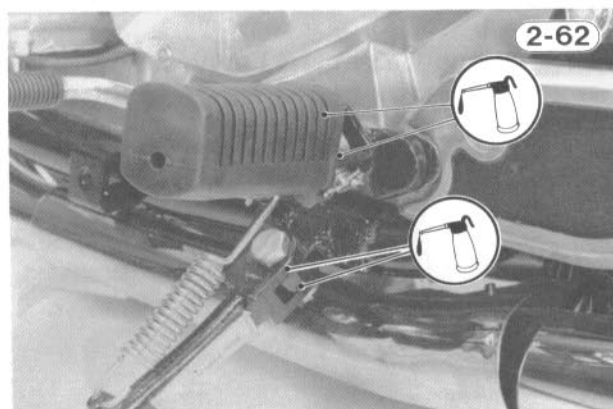

Brake Rod Joint

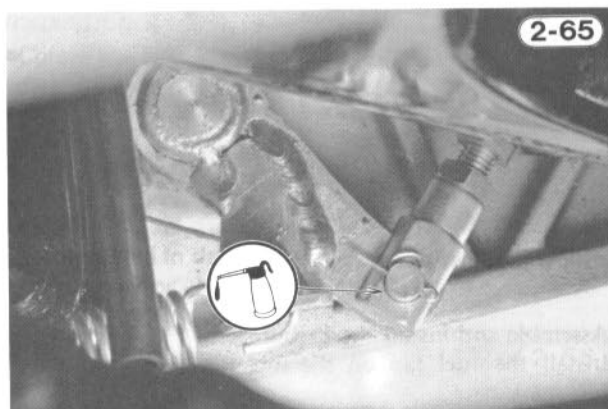

Right Footpegs, Brake Pedal

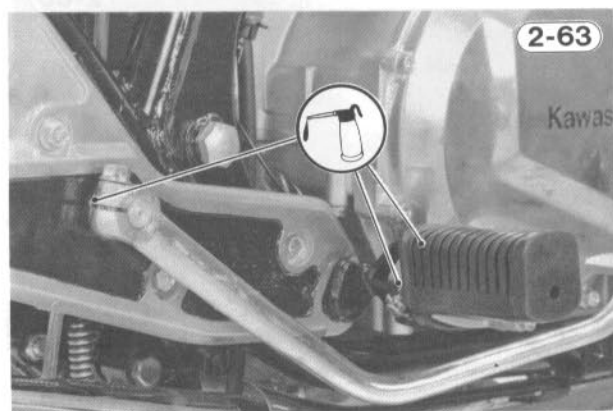

Throttle Grip

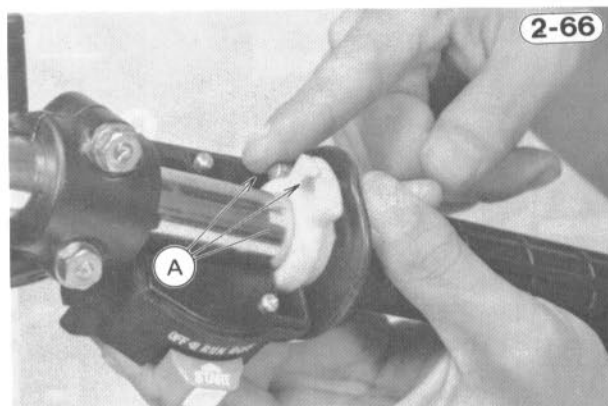

A. Grease.

Clutch and Throttle Cable Lubrication

2-67

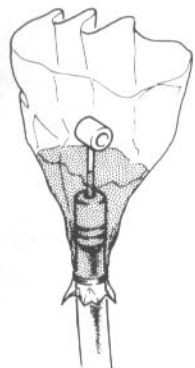

A. Grease Fitting

Carburetor Choke Link Mechanism

2-69

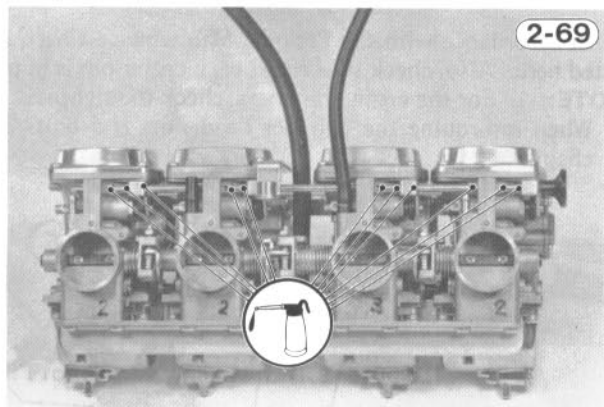

A. Choke Knob Rod

Tachometer and Speedometer Cables (KZ1000-M)

2-68

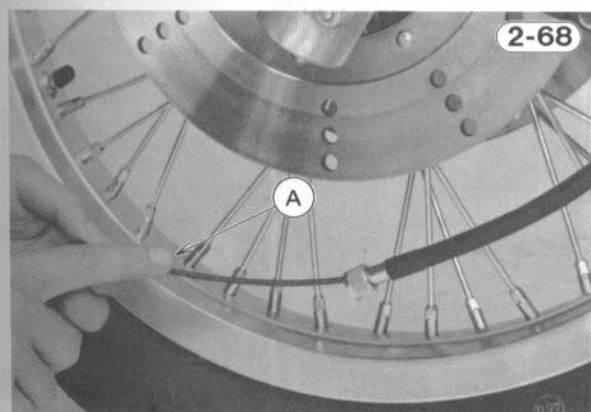

A. Grease Sparingly.

A. Grease Fitting

## BOLT AND NUT TIGHTENING

In accordance with the Periodic Maintenance Chart, it is very important to check the tightness of the bolts and nuts listed here. Also, check to see that each cotter pin is in place and in good condition.

**NOTE:** 1. For the engine fasteners, check the tightness of them when the engine is cold (at room temperature).

2. When retorquing the cylinder head nuts and bolts, follow the tightening sequence specified in the "Disassembly" chapter.

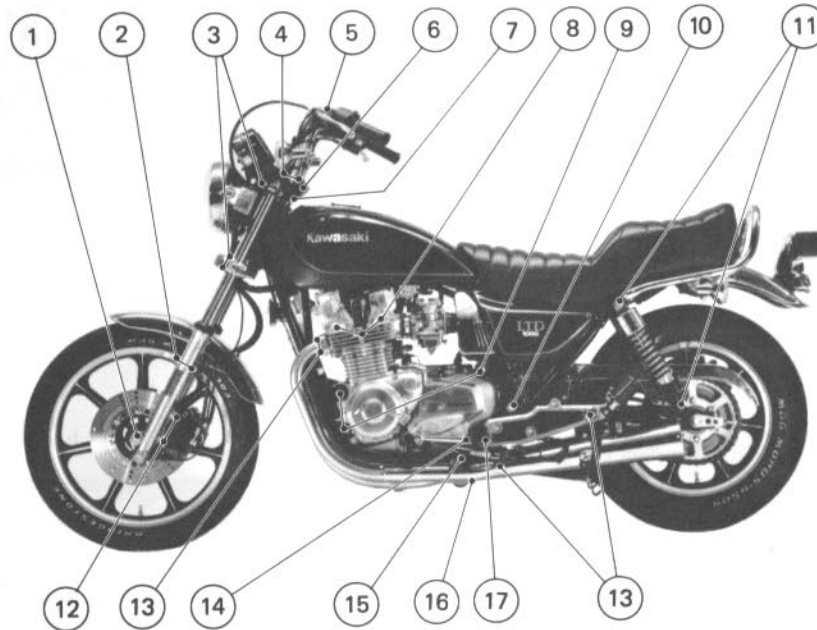

2-70

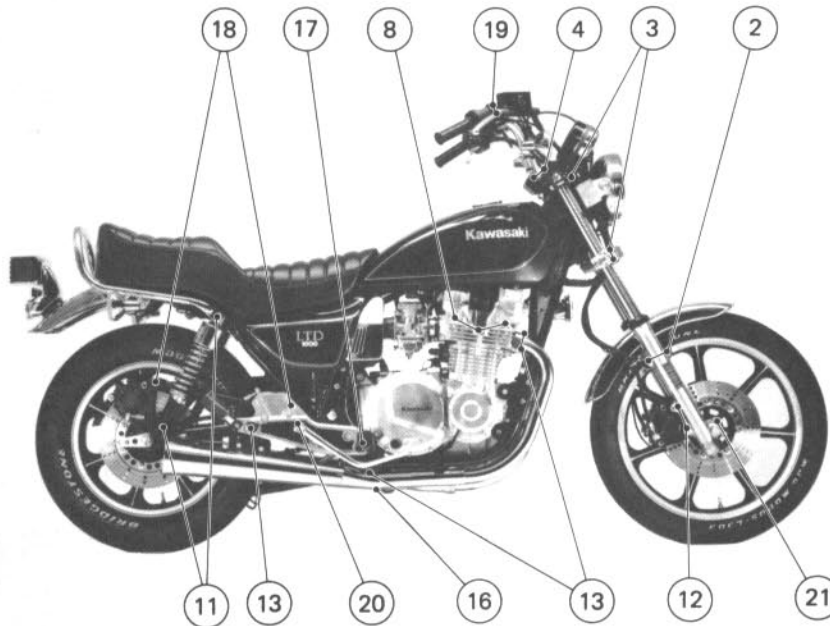

2-71

1. Front Axle Nut
2. Front Fender Bolts
3. Front Fork Clamp Bolts
4. Handlebar Clamp Bolts
5. Clutch Lever Holder Bolt
6. Stem Head Bolt

7. Stem Head Clamp Bolt
8. Cylinder Head Nuts and Bolts
9. Engine Mounting Bolts and Nuts
10. Pivot Shaft Nut
11. Rear Shock Absorber Bolts and Nuts

12. Caliper Mounting Bolts
13. Muffler Mounting Bolts and Nuts
14. Shift Pedal Bolt
15. Side Stand Bolt
16. Muffler Connecting Pipe Clamp Bolts

17. Footpeg Mounting Nut
18. Torque Link Nuts
19. Master Cylinder Clamp Bolts
20. Brake Pedal Bolt
21. Front Axle Clamp Bolt

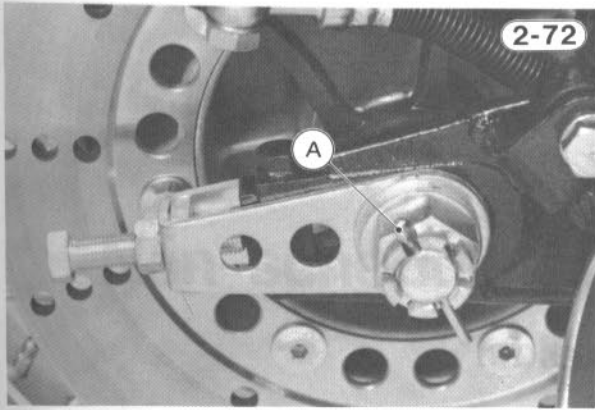

A. Cotter Pin (Rear axle nut)

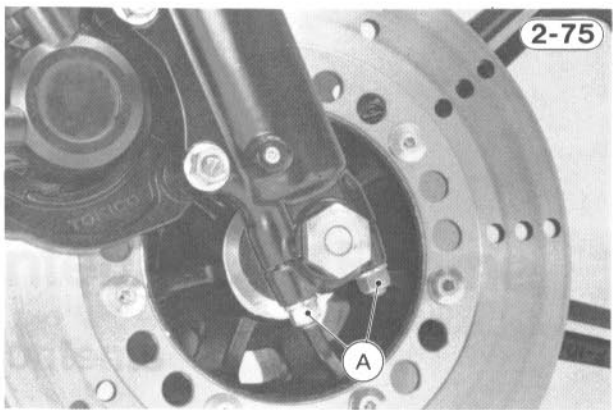

A. Front Axle Clamp Nuts (KZ/Z1000-J)

FLY  
CA  
CAV

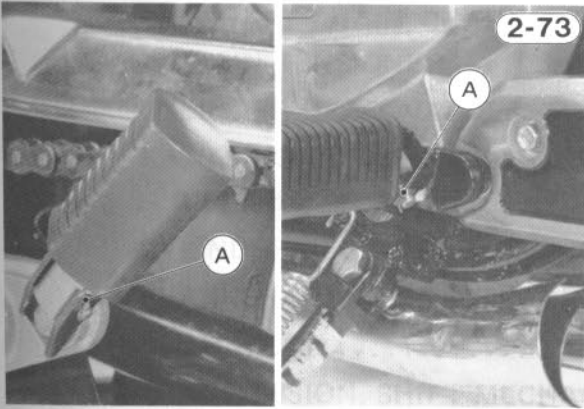

A. Cotter Pin

ENGINE

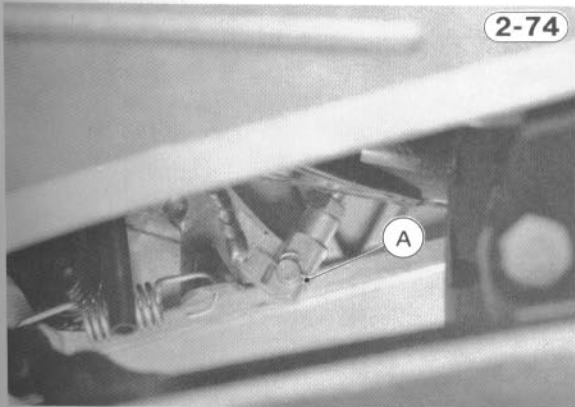

A. Cotter Pin

# Non-scheduled Maintenance – Engine

## Table of Contents

FUEL TANK, FUEL TAP .....	3-2
CARBURETORS .....	3-2
CAMSHAFTS .....	3-5
CAMSHAFT CHAIN, CHAIN GUIDES, CHAIN TENSIONER .....	3-6
CYLINDER HEAD, VALVES .....	3-7
KAWASAKI CLEAN AIR SYSTEM (US Model) .....	3-13
CYLINDER BLOCK, PISTONS .....	3-14
CRANKSHAFT, CONNECTING RODS .....	3-18
CLUTCH .....	3-20
TRANSMISSION, SHIFT MECHANISM .....	3-22
ENGINE LUBRICATION SYSTEM .....	3-25

Model	Part No.	Part Name	Quantity	Notes
KL150	150-1100-00	Oil Seal	1	
KL150	150-1100-01	Oil Seal	1	
KL150	150-1100-02	Oil Seal	1	
KL150	150-1100-03	Oil Seal	1	
KL150	150-1100-04	Oil Seal	1	
KL150	150-1100-05	Oil Seal	1	
KL150	150-1100-06	Oil Seal	1	
KL150	150-1100-07	Oil Seal	1	
KL150	150-1100-08	Oil Seal	1	
KL150	150-1100-09	Oil Seal	1	
KL150	150-1100-10	Oil Seal	1	

## FUEL TANK, FUEL TAP

If fuel leaks from the tank cap or from around the fuel tap or if there is any doubt as to the operation of the fuel tap, inspect the fuel tap and tank cap as follows.

- Drain the fuel tank.
- Remove the fuel tank, and remove the fuel tap from the tank.
- Disassemble the fuel tap, and inspect the parts and surfaces listed below for deterioration, swelling, scratch, or other damage.
  - O-rings: one on the fuel tap body and another on the diaphragm assembly
  - Valve O-ring seating surface
  - Diaphragm
  - Rubber tank cap gasket
  - Mating surfaces: diaphragm cover, tap body, tap lever, and fuel tank
  - Valve gasket

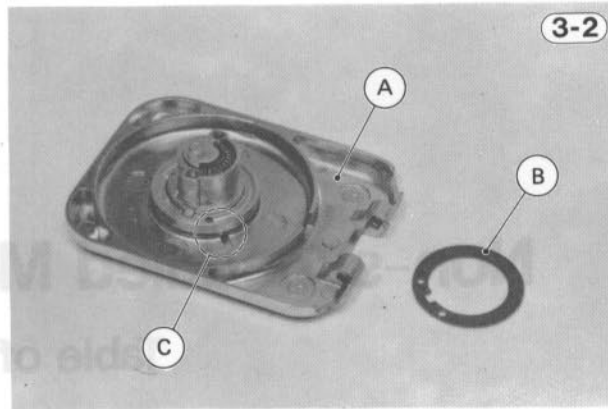

A. Tank Cap  
B. Gasket  
C. Air Vent

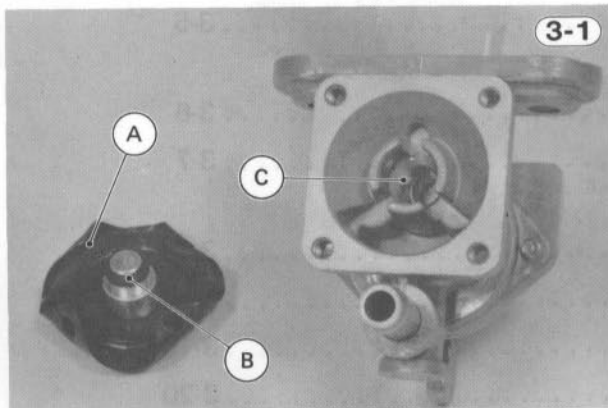

A. Diaphragm Assembly  
B. O-Ring  
C. O-Ring Seat

★ Replace the damaged parts.

- Clean the air and fuel passages by lightly applying compressed air to the passage openings.

**CAUTION**

1. Do not use wire for cleaning as this could damage the check valve, O-ring seat, and diaphragm mating surfaces.

If sufficient fuel does not reach the carburetors, the air vent in the tank cap may be obstructed.

- Disassemble the tank cap.
- Use compressed air to clear an obstructed vent.

## CARBURETORS

Carburetor trouble can be caused by dirt, wear, maladjustment, or improper fuel level in the float chamber. A dirty or damaged air cleaner can also alter the fuel-to-air ratio.

Table 3-1 Mixture Trouble Symptoms

- Poor running
- Overheating
- Exhaust smokes excessively
- Frequent backfiring in the exhaust system during engine braking

The following explanation covers the inspection of the carburetor.

### Inspection

- Inspect the float for damage.
- ★ If it is damaged, replace it.
- Check the float valve for wear.
- ★ If the needle is worn as shown in the diagram, replace the valve needle and valve seat as a set.

Table 3-2 Carburetor Specifications

Type	Main Jet	Needle Jet	Jet Needle		Pilot Jet	Starter Jet	Main Air Jet	Pilot Air Jet		Pilot Screw
			US Model	Other than US Models				J	K M	
BS34	J: 127.5R K M: 122.5R	J: Y-6 K M: Y-1	J: 5FLZ49 K M: 5FL51	J: 5FLZ50-3 K M: 5FL52-3	37.5	Jet 1: 65 Jet 2: 0.8	85	Jet 1: 170 Jet 2: 210	350	1 1/4 turns out

J : KZ/Z1000-J

K : KZ/Z1000-K

M : KZ1000-M

## Valve Needle

3-3



Good



Bad

- Remove the pilot screw, and check that the tapered portion of the pilot screw is not worn or otherwise deformed.

★ If it is, replace the screw.

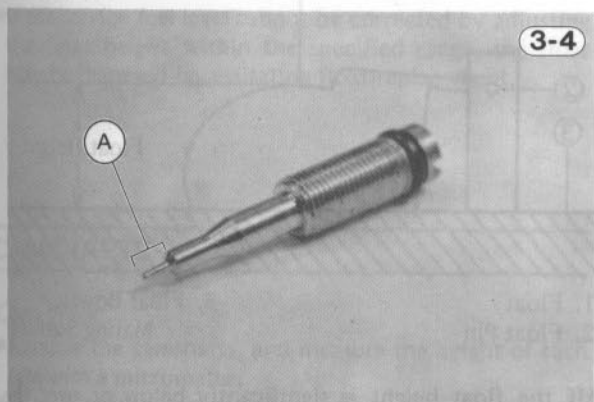

3-4

A. Tapered Portion

- Visually inspect the diaphragms of the vacuum pistons and coasting enricher.

★ If there is any damage, the diaphragm should be replaced.

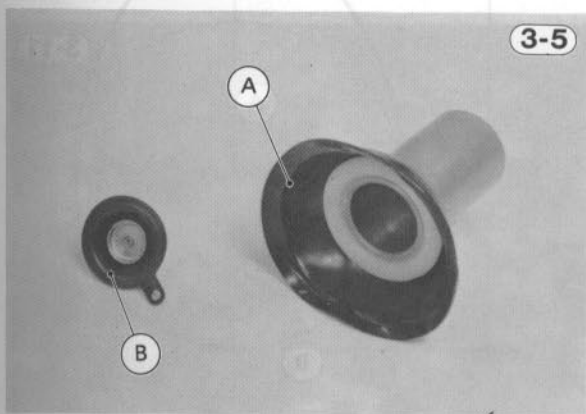

3-5

A. Vacuum Piston Diaphragm  
B. Coasting Enricher Diaphragm (KZ/Z1000-J only)

- Check the jet needle and needle jet.
- ★ A worn needle jet and jet needle should be replaced.

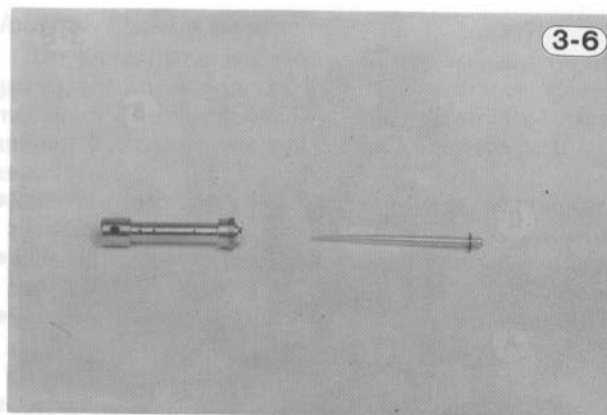

3-6

**NOTE:** 1. The last number of the jet needle number ("3" of 5FLZ50-3 or 5FL52-3) is not stamped on the needle, but is the number of the groove in which the clip **must** be installed. The groove numbers are counted from the topmost groove, 5 being the lowest groove.

**CAUTION** 1. If the clip is put in any but the specified groove, exhaust emission will be increased, and the engine may suffer serious damage which could result in a crash.

## Jet Needle

3-7

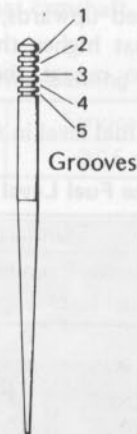

Grooves

*Service fuel level measurement and adjustment*

If the motorcycle exhibits symptoms of improper fuel mixture, measure the service fuel level.

**WARNING** 1. Check the fuel level in a well-ventilated area, and take ample care that there are no sparks or flame anywhere near the working area.

- Remove the carburetors, and hold them in a true vertical position on a stand.
- Put the fuel tank on a bench, and connect the fuel tap to the carburetors using a suitable hose.
- Prepare a rubber hose (6 mm in diameter and about 300 mm long).
- Connect one end of the rubber hose with the carburetor float bowl, and insert the other end into the fuel level gauge (special tool).

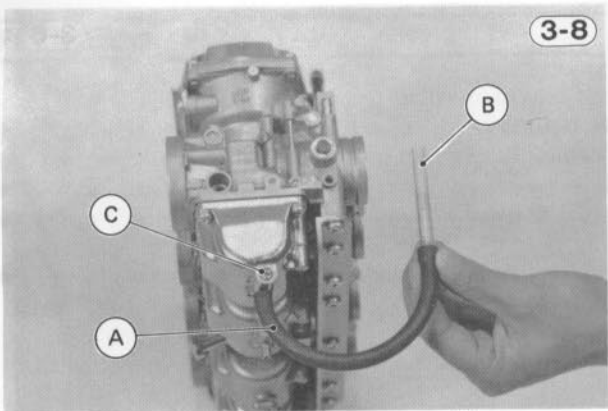

A. Rubber Hose C. Drain Plug  
B. Fuel Level Gauge: 57001-1017

- Holding the gauge against the side of the carburetor body so that "0" line is several millimeters higher than the bottom edge of the carburetor body, turn the fuel tap lever to the "PRI" position and turn out the carburetor drain plug 1 - 2 turns to feed fuel to the carburetor and gauge.
- Wait until the fuel level in the gauge settles.
- Keeping the fuel level gauge vertical, slowly lower the gauge until the "0" line is even with the bottom edge of the carburetor body.

**NOTE:** 1. Do not lower the "0" line below the bottom edge of the carburetor body. If the gauge is lowered and then moved upwards, the fuel level measured shows somewhat higher than the actual fuel level, necessitating to repeat the measurement from the beginning.

- Read the service fuel level in the gauge.

Table 3-3 Service Fuel Level

Standard
3 ± 1 mm below from bottom edge of carburetor body to fuel level

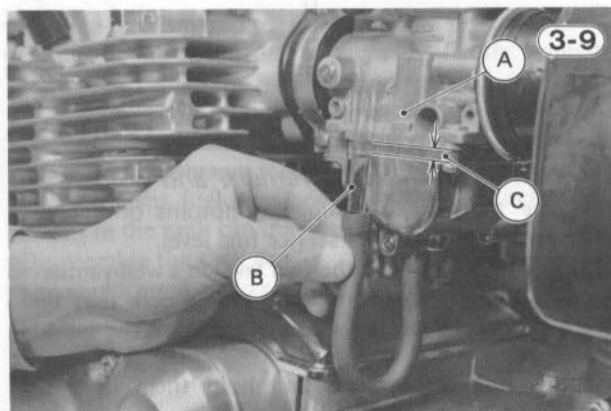

A. Carburetor Body C. Service Fuel Level  
B. Gauge

- Tighten the drain plug, and remove the gauge and rubber hose.
- Measure the fuel level in the other carburetors in the same manner.

- Turn the fuel tap lever to the "ON" position to shut off the tap.
  - ★ If the fuel level is incorrect, adjust it as follows.
  - Drain all carburetors, and remove the float bowls and gaskets.
  - Put the carburetors upside down on the working bench, and measure the float height of each carburetor. Take measurements for both floats in each carburetor.
- NOTE:** 1. Float height is the vertical distance from the float bowl mating surface of the carburetor body to the top of the float.

Table 3-4 Float Height

Float Height	18.6 mm
--------------	---------

Float Height Measurement

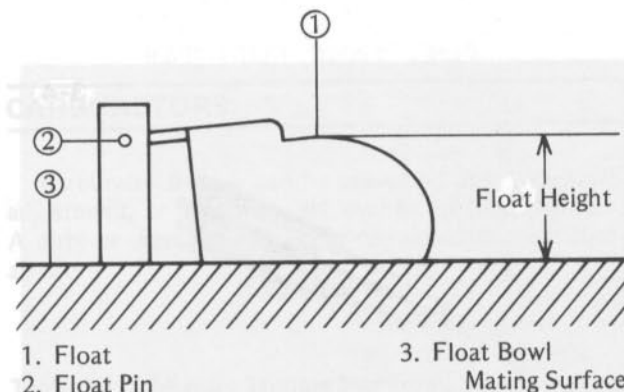

1. Float 3. Float Bowl Mating Surface  
2. Float Pin

- ★ If the float height is significantly below or over the specified value, adjust it as follows.
- Tap out the float pin, and remove the float and the valve needle.
- Check the valve needle and the valve seat for wear.
- ★ If they are worn, replace them as an assembly.
- Push the rod in the valve needle, then release it.
- ★ If the rod does not come out fully by spring tension, replace the valve needle and valve seat as assembly.

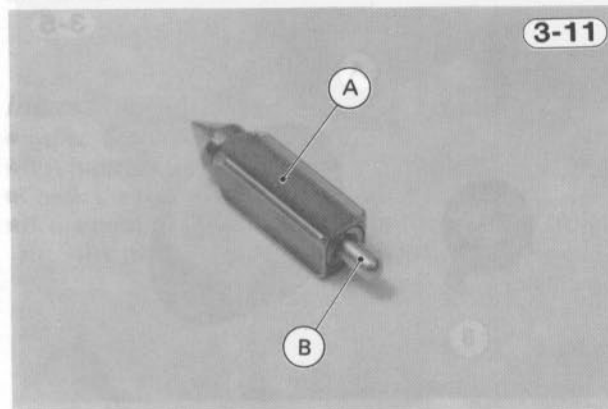

A. Valve Needle B. Rod

- Bend the tang on the float a very slight amount to change the float height. Increasing the float height lowers the fuel level, and decreasing the float height raise the fuel level.



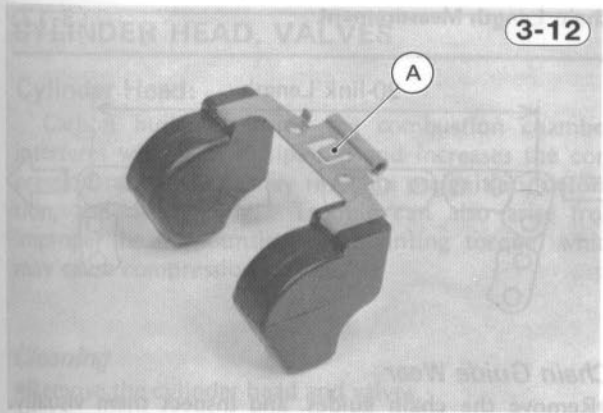

3-12

A. Tang

- After adjustment, assemble the carburetors, and measure the service fuel level again. Readjust if necessary.
- ★ If the service fuel level cannot be corrected by adjusting the float height within the specified range, the float may be damaged necessitating float replacement.

CAMSHAFTS

Cam Wear

- Remove the camshafts, and measure the height of each cam with a micrometer.
- ★ If the cams are worn down past the service limit, replace the camshafts.

Cam Height Measurement

3-13

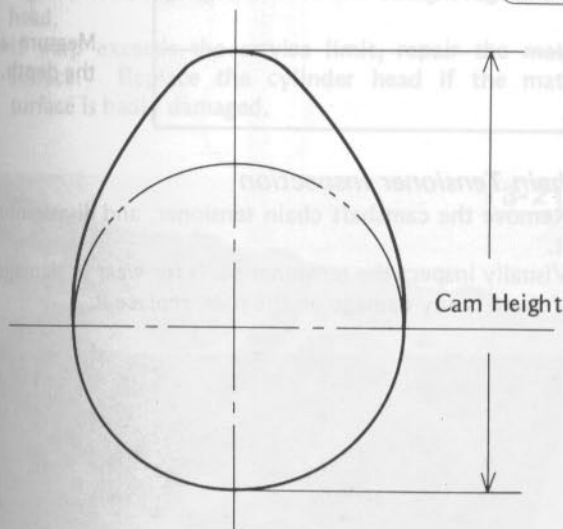

Table 3-5 Cam Height

Models	Standard mm	Service Limit mm
KZ/Z1000-J	In 36.910 – 37.090	36.80
	Ex 36.510 – 36.690	36.40
KZ/Z1000-K, M	36.006 – 36.186	35.91

Journal, Bearing Wear

The journal wear is measured using plastigauge (press gauge), which is inserted into the clearance to be measured. The plastigauge indicates the clearance by the amount it is compressed and widened when the parts are assembled.

- Remove the cylinder head and camshafts, and remove all valves.
  - Wipe all camshaft journal and bearing insert surfaces clean of oil.
  - Seat the camshaft in the bearings, and set the camshaft axially in correct position by installing the left camshaft cap in place.
  - Cut strips of plastigauge to journal width, and place strips on the right two camshaft journals parallel to the camshaft and so that the plastigauge will be compressed between the journal and the bearing insert.
  - Install the right camshaft cap, tightening the bolts in the correct sequence to the specified torque.
- NOTE:** 1. Do not turn the camshaft when plastigauge is between the journal and insert.
- Remove the left camshaft cap, and press the plastigauge between the left two camshaft journals and the bearing inserts in the same manner as explained previous two steps.
  - Remove the left and right camshaft caps, and measure the plastigauge width to determine the clearance between each journal and bearing insert.
  - ★ If any clearance exceeds the service limit, replace all eight bearing inserts for that camshaft.

Table 3-6 Camshaft Journal/Bearing Insert Clearance

Standard	Service Limit
0.020 – 0.070 mm	0.16 mm

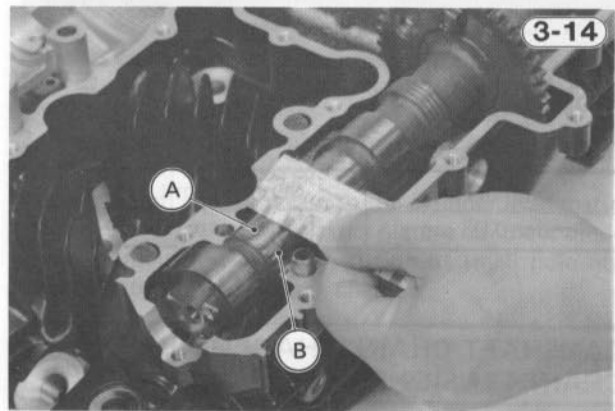

3-14

A. Plastigauge

B. Camshaft Journal

- Measure the diameter of each camshaft journal with a micrometer.
- ★ If a diameter is less than the service limit, replace the camshaft.

Table 3-7 Camshaft Journal Diameter

Standard	Service Limit
24.459 – 24.480 mm	24.42 mm

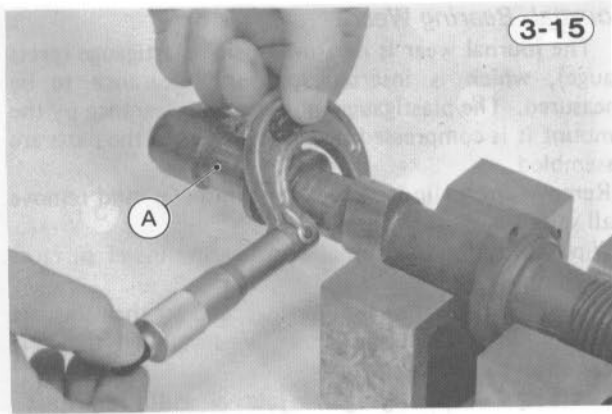

3-15

**A. Camshaft**

**Camshaft Runout**

- Remove the camshaft and take the sprocket off the shaft.
- Set the shaft on V blocks at the outside journals as shown in the figure.
- Measure runout with a dial gauge set to the sprocket mounting location.
- Replace the shaft if runout exceeds the service limit.

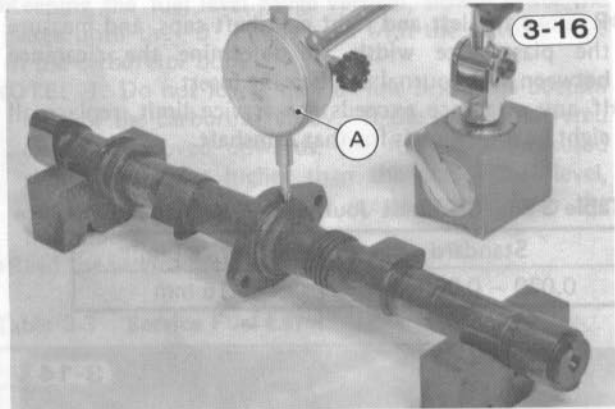

3-16

**A. Dial Gauge**

**Table 3-8 Camshaft Runout**

Standard	Service Limit
under 0.03 mm	0.1 mm

**CAMSHAFT CHAIN, CHAIN GUIDES, CHAIN TENSIONER**

**Camshaft Chain Wear**

- Hold the chain taut with a force of about 5 kg in some manner, and measure a 20-link length. Since the chain may wear unevenly, take measurements at several places.
- ★ If any measurement exceeds the service limit, replace the chain.

**Table 3-9 Camshaft Chain 20-Link Length**

Standard	Service Limit
127.00 – 127.16 mm	128.9 mm

**Chain Length Measurement**

3-17

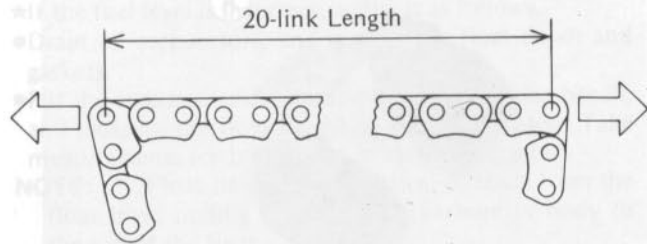

**Chain Guide Wear**

- Remove the chain guides, and inspect them visually.
- ★ Replace a guide if the rubber or any other portion is damaged.
- Measure the depth of the grooves where the chain links run.
- ★ Replace the guide if the depth exceeds the service limit.

**Table 3-10 Camshaft Chain Guide Groove Depth**

	Standard	Service Limit
Upper	0 mm	4.3 mm
Front and Rear	1.0 – 1.5 mm	3.3 mm

**Chain Guide Rubber Wear**

3-18

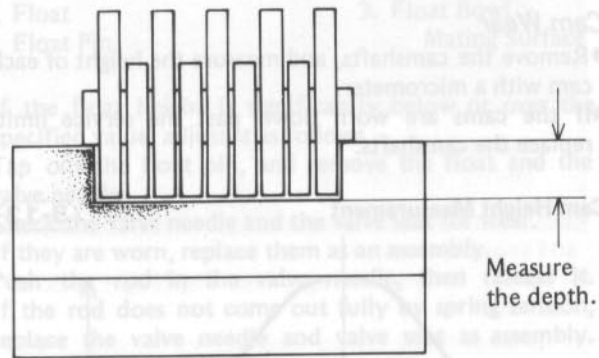

**Chain Tensioner Inspection**

- Remove the camshaft chain tensioner, and disassemble it.
- Visually inspect the tensioner parts for wear or damage.
- If there is any damage on the part, replace it.

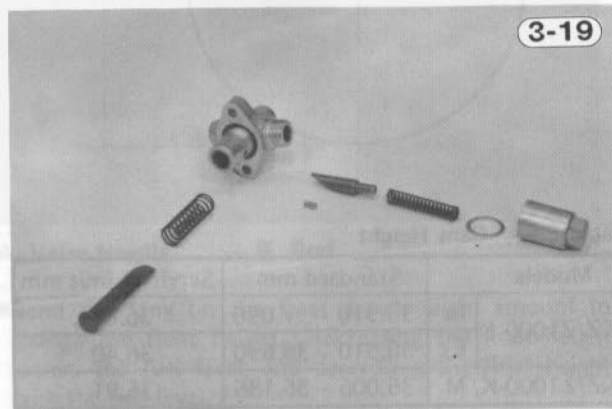

3-19

## CYLINDER HEAD, VALVES

### Cylinder Head:

Carbon built up inside the combustion chambers interferes with heat dissipation and increases the compression ratio; which may result in preignition, detonation, and overheating. Trouble can also arise from improper head mounting or mounting torque, which may cause compression leakage.

### Cleaning

- Remove the cylinder head and valves.
- Scrape out any carbon, and wash the head with a high flash-point solvent.

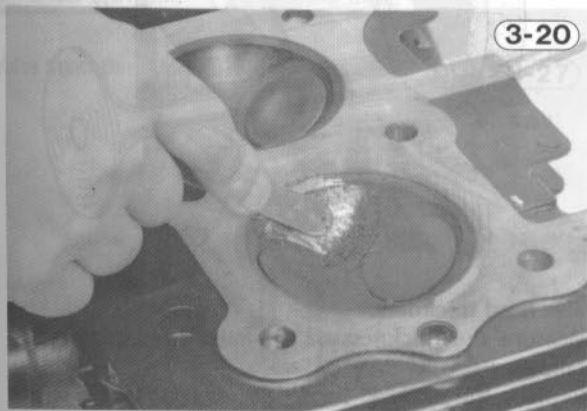

### Cylinder Head Warp

- Lay a straightedge across the lower surface of the head at several different points, and measure warp by inserting a thickness gauge between the straightedge and the head.
- \*If warp exceeds the service limit, repair the mating surface. Replace the cylinder head if the mating surface is badly damaged.

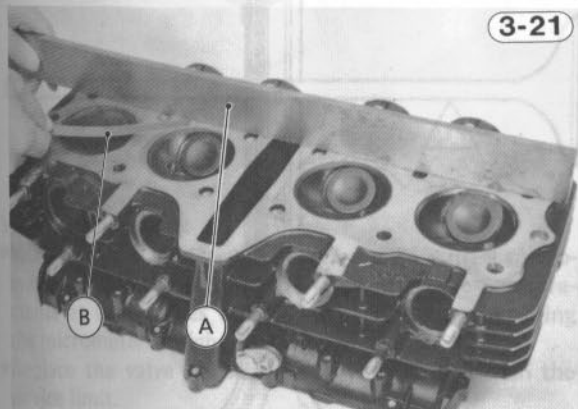

A. Straightedge

B. Thickness Gauge

Table 3-11 Cylinder Head Warp

Service Limit	0.05 mm

### Combustion Chamber Volume measurement

The combustion chamber volume should be measured any time that compression measurement results in compression pressures well below or above the standard.

- NOTE:** 1. Another person will be needed to help expel air bubbles out of the combustion chamber.
2. Prepare a piece of transparent plastic plate which has a flat surface and two holes about 35 mm apart in its center portion. One hole should be about 6 mm in diameter. The plate must be oil resistant, about 120 mm square, and at least 3 mm thick.

### Plastic Measuring Plate

3-22

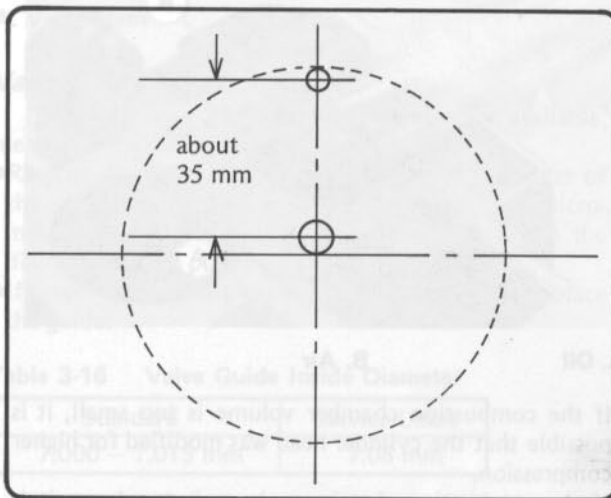

3. Obtain a burette or syringe which is calibrated at one-cc or smaller graduations. Fill it with light oil such as 2-stroke oil.
- Clean off any carbon in the combustion chamber, and remove any gasket flakes on the cylinder head mating surface.
- NOTE:** 1. The valves must seat well to prevent the oil from leaking out.
2. The standard spark plug should be installed in the chamber to be measured.
- Apply a thin coat of grease to the cylinder head mating surface and place the plastic plate over the cylinder head combustion chamber, fitting its small hole near the edge of the combustion chamber.

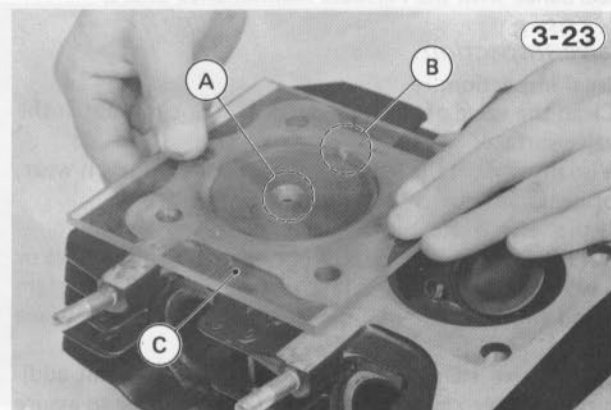

A. Large Hole

B. Small Hole

C. Plastic Plate

●Through the large hole, fill the combustion chamber with oil until the chamber is completely but not overly filled. Tilt the cylinder head slightly so that air bubbles come out through the small hole. The oil should just rise to the bottom edge of the holes in the plate. The amount of oil used to fill the chamber is the combustion chamber volume.

Table 3-12 Combustion Chamber Volume

Standard	39.5 – 40.3 cc
----------	----------------

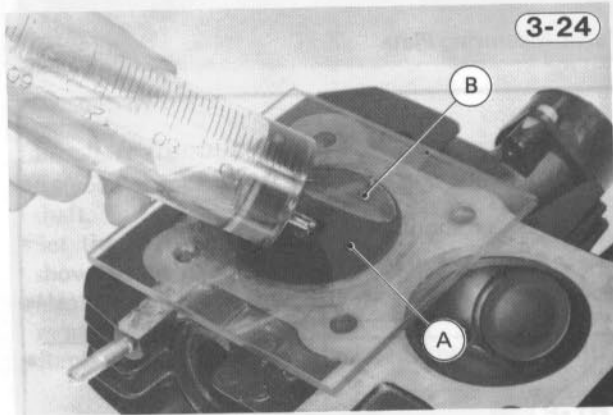

A. Oil                      B. Air

- ★If the combustion chamber volume is too small, it is possible that the cylinder head was modified for higher compression.
- ★If the combustion chamber volume is too large, it is possible that the valves and valve seats have been resurfaced so much that the volume is increased.

**Valve, Valve Guide, Valve Seat:**

Valve face deformation or wear, stem bending or wear, and valve guide wear can cause poor valve seating. Poor seating can also be caused by the valve seat itself, if there is heat damage or carbon build-up. The result of poor valve seating is compression leakage and a loss of engine power.

In addition, valve and valve seat wear causes deeper valve seating and a decrease in valve clearance. Insufficient clearance upsets valve timing and may eventually prevent the valve from seating fully. So that wear never progresses this far, adjust the valve clearance in accordance with the Periodic Maintenance Chart.

*Valve Inspection*

**Visual inspection:**

- Clean the valve of carbon. Be careful not to scratch the valve surface.
- Visually inspect the valve for deformation, uneven wear, or heat damage.
- ★If the valve is damaged, replace the valve.

**NOTE:** 1. If a valve refacer is available, light damage or worn of the valve seating surface or the valve stem end can be repaired. The angle of the seating surface is 45°.

2. The valve stem end may be ground to permit additional valve clearance, use a refacing grinder to assure a flat, square surface.

**CAUTION** 1. If the valve's Dimension "A" (Fig. 3-26) is less than specified, the valve lifter may contact the valve spring retainer during operation, allowing the keepers to loosen. Consequently, the valve may drop into the engine, causing serious damage.

**Valve Stem Grinding**

3-25

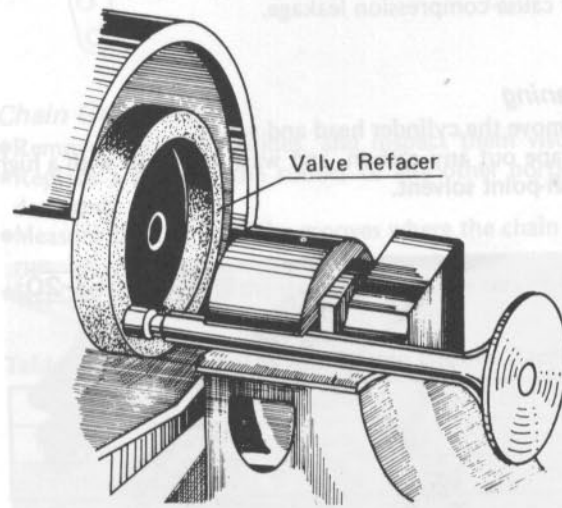

**Valve head thickness:**

- Measure the thickness of the valve head using vernier calipers.
- ★Replace the valve if the thickness is under the service limit.

**Valve**

3-26

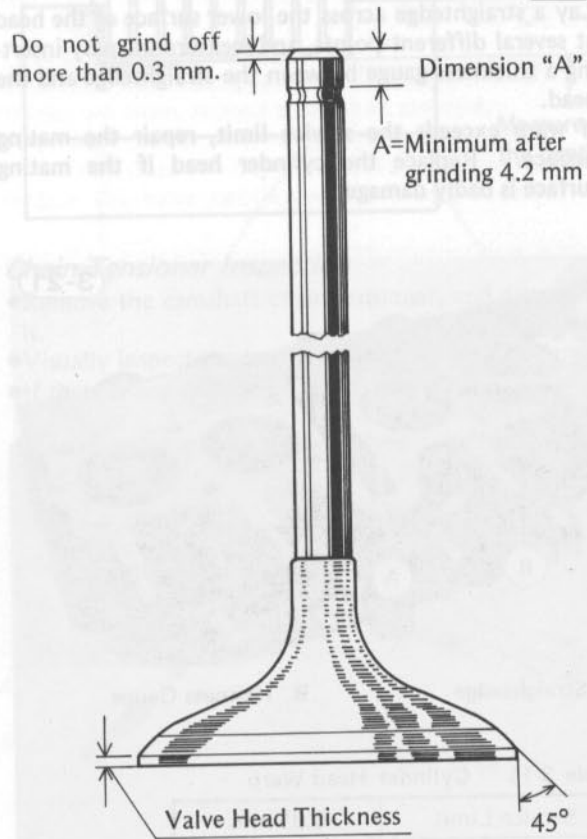

**Table 3-13 Valve Head Thickness**

	Standard	Service Limit
Inlet	1 mm	0.5 mm
Exhaust	1 mm	0.7 mm

**Valve stem bend:**

- Support the valve at both ends of the straight stem portion, and set a dial gauge against the center of the stem.
- Turn the valve and read the variation in the dial gauge.
- ★Replace the valve if it is bent over the service limit.

**Table 3-14 Valve Stem Bend**

Standard	Service Limit
under 0.01 mm	0.05 mm

**Valve Stem Bend Measurement**

3-27

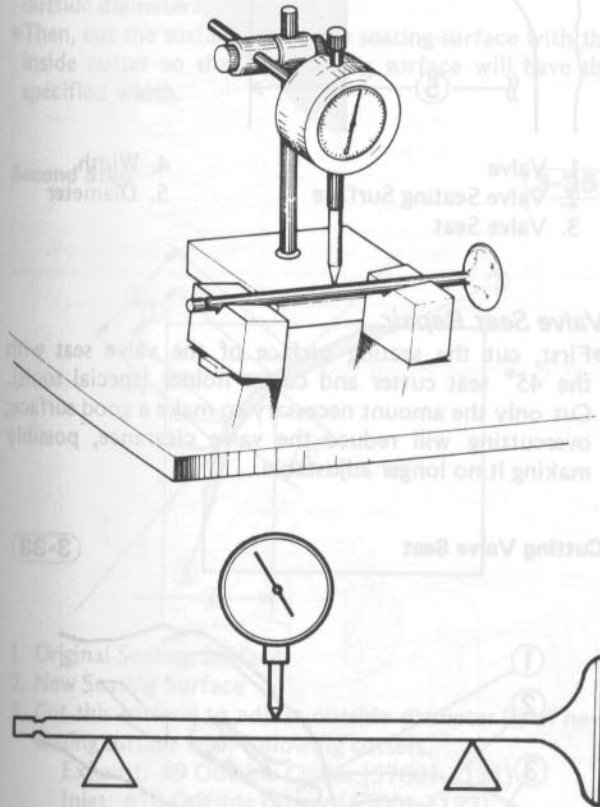

**Valve stem diameter:**

- Measure the diameter of the valve stem with a micrometer. Since the stem wears unevenly, take measurements at four places up and down the stem, keeping the micrometer at right angles to the stem.
- ★Replace the valve if the stem is worn to less than the service limit.

**Table 3-15 Valve Stem Diameter**

	Standard	Service Limit
Inlet	6.965 – 6.980 mm	6.95 mm
Exhaust	6.955 – 6.970 mm	6.94 mm

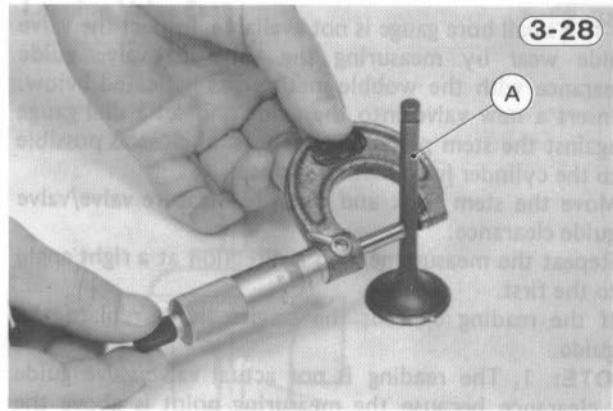

**A. Valve Stem**

**Valve Guide Inside Diameter**

If a small bore gauge and micrometer are available, measure the valve guide as follows.

- Remove the valve, and measure the inside diameter of the valve guide using a small bore gauge and micrometer. Since the guide wears unevenly, measure the diameter at four places up and down the guide.
- ★If any measurement exceeds the service limit, replace the guide.

**Table 3-16 Valve Guide Inside Diameter**

Standard	Service Limit
7.000 – 7.015 mm	7.08 mm

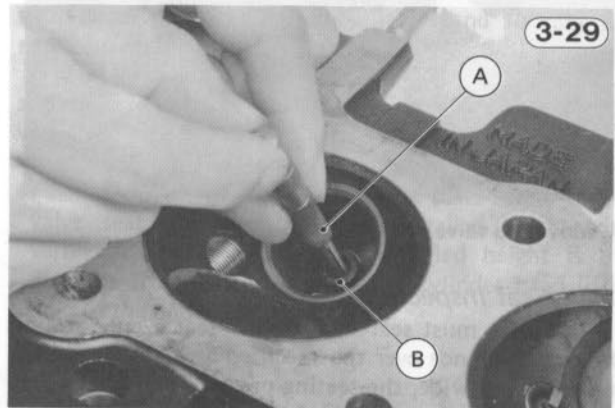

**A. Bore Gauge**

**B. Valve Guide**

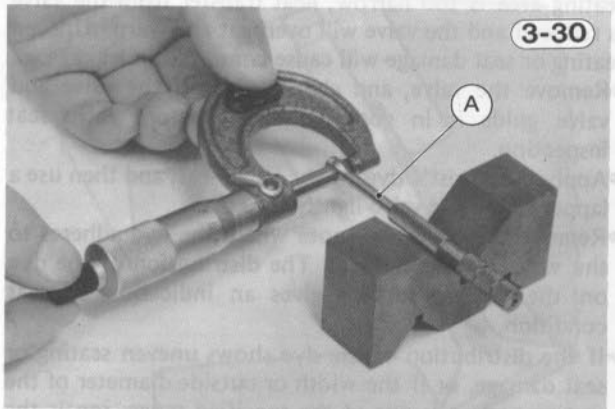

**A. Bore Gauge**

If a small bore gauge is not available, inspect the valve guide wear by measuring the valve to valve guide clearance with the wobble method, as indicated below.

- Insert a new valve into the guide and set a dial gauge against the stem perpendicular to it as close as possible to the cylinder head mating surface.
- Move the stem back and forth to measure valve/valve guide clearance.
- Repeat the measurement in a direction at a right angle to the first.
- ★ If the reading exceeds the service limit, replace the guide.

**NOTE:** 1. The reading is not actual valve/valve guide clearance because the measuring point is above the guide.

**Table 3-17 Valve/Valve Guide Clearance (Wobble Method)**

	Standard	Service Limit
Inlet	0.05 – 0.12 mm	0.24 mm
Exhaust	0.07 – 0.13 mm	0.22 mm

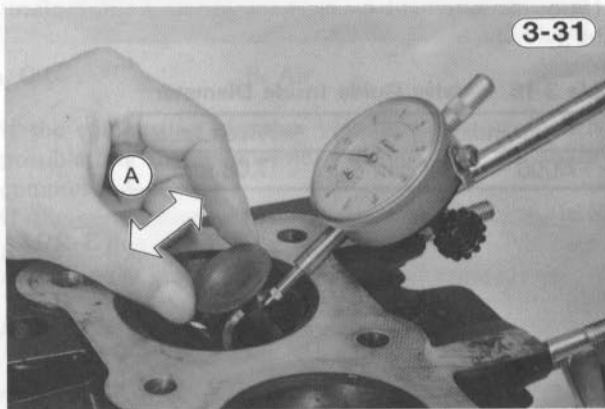

A. Move the valve.

**Valve Seat Inspection**

The valve must seat in the valve seat evenly around the circumference over the specified area. If the seating surface is too wide, the seating pressure per unit of area is reduced, which may result in compression leakage and carbon accumulation on the seating surface. If the seating area is too narrow, heat transfer from the valve is reduced and the valve will overheat and warp. Uneven seating or seat damage will cause compression leakage.

- Remove the valve, and check to see if the valve and valve guide is in good condition before valve seat inspection.
- Apply machinist's dye to the valve seat, and then use a lapper to tap the valve lightly into place.
- Remove the valve, and note where the dye adheres to the valve seating surface. The distribution of the dye on the seating surface gives an indication of seat condition.
- ★ If the distribution of the dye shows uneven seating or seat damage, or if the width or outside diameter of the seating surface is out of the specified range, repair the valve seat.

**Table 3-18 Valve Seating Surface**

	Inlet	Exhaust
Outside Diameter	35.9 – 36.1 mm	30.9 – 31.1 mm
Width	0.8 – 1.2 mm	0.8 – 1.2 mm

**Valve and Valve Seat**

3-32

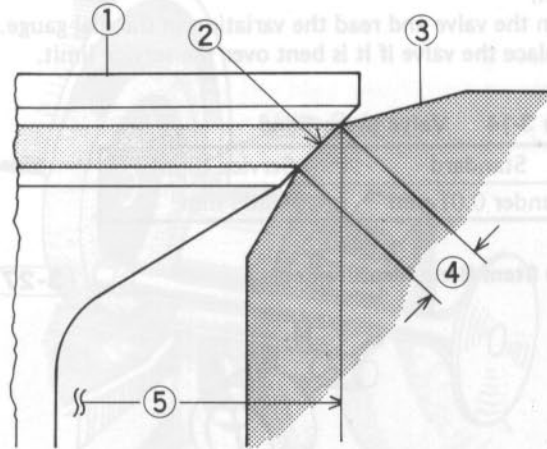

- 1. Valve
- 2. Valve Seating Surface
- 3. Valve Seat
- 4. Width
- 5. Diameter

**Valve Seat Repair**

- First, cut the seating surface of the valve seat with the 45° seat cutter and cutter holder (special tools). Cut only the amount necessary to make a good surface; overcutting will reduce the valve clearance, possibly making it no longer adjustable.

**Cutting Valve Seat**

3-33

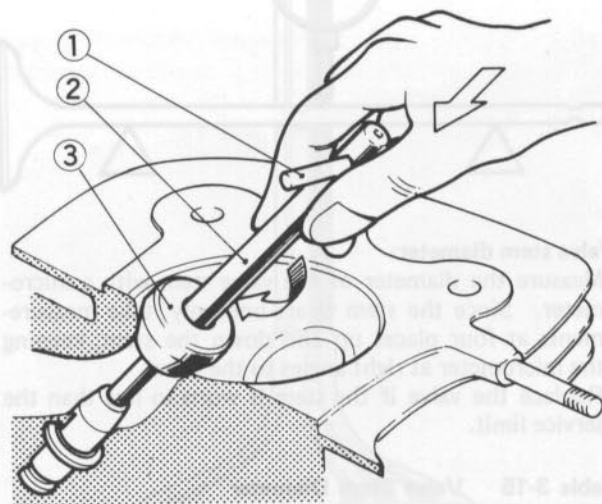

- 1. Bar: 57001-1128
- 2. 7.0 mm Cutter Holder: 57001-1126
- 3. Cutter

## First Step

3-34

- Cut seating surface with following cutters.  
Exhaust: #4 Seat Cutter (57001-1116)  
Inlet: #5 Seat Cutter (57001-1117)

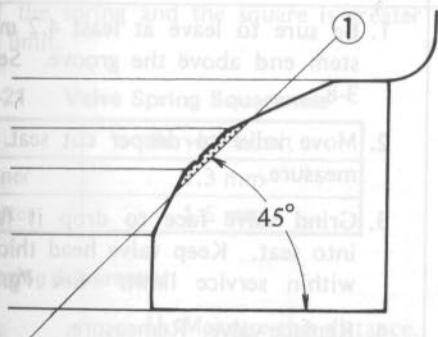

- Next, cut the outermost surface with the outside cutter so that the valve seating surface will have the specified outside diameter.
- Then, cut the surface inside the seating surface with the inside cutter so that the seating surface will have the specified width.

## Second Step

3-35

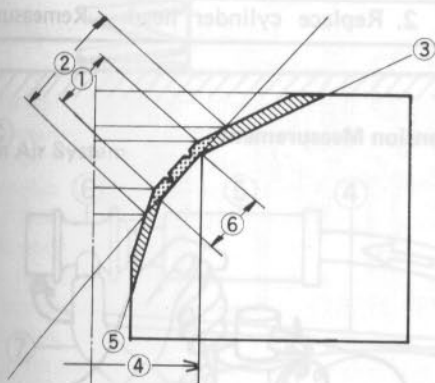

- Original Seating Surface
- New Seating Surface
- Cut this surface to adjust outside diameter ④ of new seating surface with following cutters.  
Exhaust: #9 Outside Cutter (57001-1121)  
Inlet: #10 Outside Cutter (57001-1122)
- Seating Surface Outside Diameter
- Cut this surface to obtain correct width ⑥ with following cutters.  
Exhaust and Inlet: #12 Inside Cutter (57001-1124)

After cutting, lap the valve to properly match the valve and valve seat surfaces. Start off with coarse lapping compound, and finish with fine compound.

- Apply compound to the valve seat, and tap the valve lightly into place while rotating it with a lapper, repeating this until a smooth, matched surface is obtained.
- When lapping is completed, check the valve installed height and adjust if necessary.

## Lapping Valve Seat

3-36

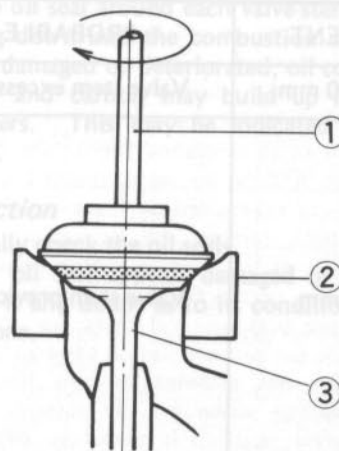

- Lapper
- Valve Seat
- Valve

## Valve Installed Height

A selection of various thickness valve shims are available for adjusting the valve clearance. There is, however, a limit to the amount of adjustment possible using the shims. Resurfacing of the valve face and valve seat inevitably drops the valve deeper into the valve seat, allowing the valve stem end to come closer to the camshaft. Consequently, a thinner shim must be used to compensate for the reduced valve clearance.

Over a period of long use and repeated resurfacing, the valve may drop so far into the valve seat that even the thinnest shim cannot give adequate clearance. In this case, it is possible to grind the end of the valve stem to reduce the valve installed height and to gain the needed clearance (See "CAUTION" on Pg. 3-8).

After grinding the valve or repairing the valve seat and before assembling the cylinder head, measure the valve installed height as follows.

- Install the valve in the cylinder head.
- Pushing up on the valve so that it seats firmly in the valve seat, measure the valve installed height with vernier calipers. The valve installed height is the distance from the bottom of the cylinder head lifter hole to the end of the valve stem.

## Valve Installed Height

3-37

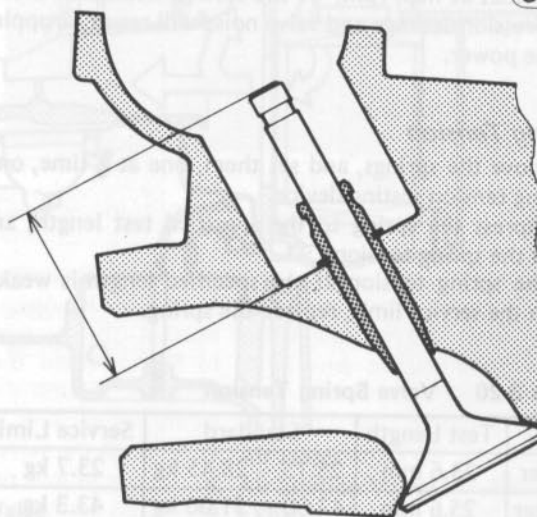

Table 3-19 Installed Valve Height

MEASUREMENT	PROBABLE CAUSE	RECOMMENDATION
Less than 36.90 mm	Valve stem excessively ground.	1. Replace valve. Remeasure.
36.90~37.19 mm	Valve stem previously ground.	1. Be sure to leave at least 4.2 mm of stem end above the groove. See Pg. 3-8. 2. Move valve to deeper cut seat. Remeasure. 3. Grind valve face to drop it farther into seat. Keep valve head thickness within service limit. See Pg. 3-8. 4. Replace valve. Remeasure.
37.20~38.00 mm	Normal/acceptable.	1. After assembling check and adjust valve clearance.
38.01~38.30 mm	Wear, or valve face and seat grinding have dropped valve too far into seat.	1. Move valve to shallower cut seat, Remeasure. 2. Grind 0.3 mm maximum off valve stem. See CAUTION, Pg. 3-8. Remeasure.
More than 38.30 mm	Valve face or seat worn out, or ground excessively.	1. Replace valve. Remeasure. 2. Replace cylinder head. Remeasure.

★Refer to Table 3-19 for the recommended repair.

**NOTE:** 1. Be sure to mark each valve so it will be properly matched to its corresponding valve seat during assembly.

### Valve Springs:

When the valve is not being pushed open by the cam, valve springs press the valve against the seat to prevent compression leakage. An inner spring is used with each outer spring to prevent spring surge, which may cause valve float at high rpm. If the springs weaken or break, compression leakage and valve noise will result, dropping engine power.

### Spring Tension

- Remove the springs, and set them, one at a time, on a spring tension testing device.
- Compress the spring to the specified test length, and read the spring tension.
- ★If the spring tension at the specified length is weaker than the service limit, replace the spring.

Table 3-20 Valve Spring Tension

	Test Length	Standard	Service Limit
Inner	23.6 mm	25.75 – 28.45 kg	23.7 kg
Outer	25.6 mm	47.00 – 51.00 kg	43.3 kg

### Spring Tension Measurement

3-38

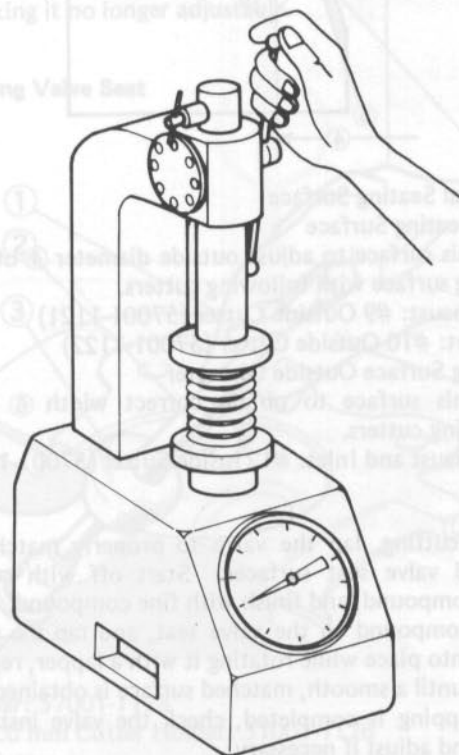



**Spring Squareness**

- Measure the squareness of each spring by standing each end on a surface plate and setting a square against it.
- ★ Replace any spring for which the distance between the top of the spring and the square is greater than the service limit.

**Table 3-21 Valve Spring Squareness**

	Service Limit
Inner	1.3 mm
Outer	1.5 mm

**Valve Spring Squareness**

3-39

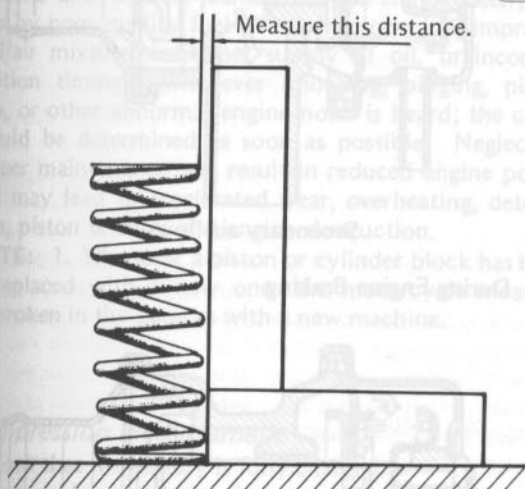

**Clean Air System**

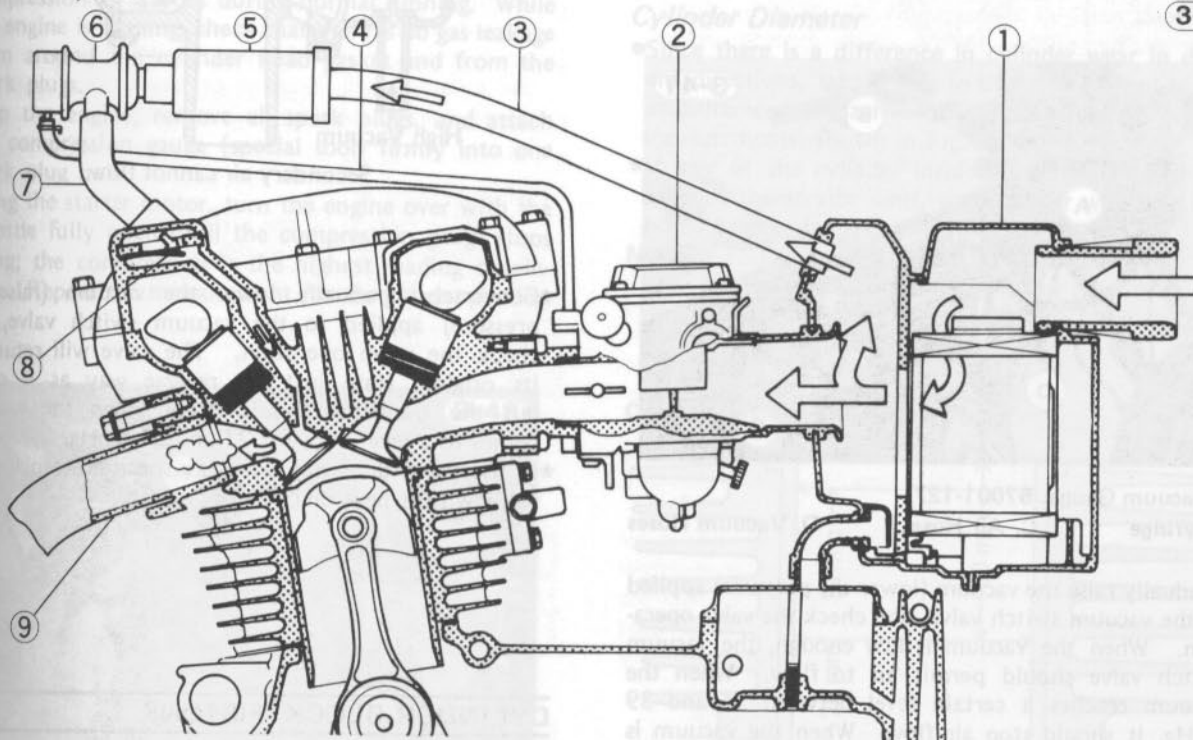

3-40

- |                |                        |                       |
|----------------|------------------------|-----------------------|
| 1. Air Cleaner | 4. Vacuum Hose         | 7. Air Hoses          |
| 2. Carburetors | 5. Silencer            | 8. Air Suction Valves |
| 3. Air Hose    | 6. Vacuum Switch Valve | 9. Exhaust Pipes      |

**Oil Seal:**

The oil seal around each valve stem prevents oil from leaking down into the combustion chamber. If an oil seal is damaged or deteriorated, oil consumption will increase, and carbon may build up in the combustion chambers. This may be indicated by white exhaust smoke.

**Inspection**

- Visually check the oil seals.
- ★ If an oil seal appears damaged or deteriorated, or if there is any doubt as to its condition, replace it with a new one.

**KAWASAKI CLEAN AIR SYSTEM (US Model)**

**Air Suction Valves:**

Remove and inspect the air suction valves periodically (Pg. 2-2). Also, remove and inspect the air suction valves whenever the idle is unstable, engine power is greatly reduced, or there are abnormal engine noises.

### Vacuum Switch Valve:

Although the vacuum switch valve usually permits secondary air flow, it shuts off the air flow when a high vacuum (low pressure) is developed at the engine side of the carburetor bores during engine braking. This is to prevent explosions in the exhaust ports which might be caused by extra unburned fuel in the exhaust during deceleration, if fresh air were injected into the exhaust ports. These explosions or "backfiring" in the exhaust system could damage the air suction valves.

Regular inspection of the vacuum switch valve is not needed. If backfiring occurs frequently in the exhaust system during engine braking or if there are abnormal engine noises, check the vacuum switch valve as follows:

#### CAUTION

1. Do not attempt to turn the paint-locked screw on the vacuum switch valve. This screw position is preset to determine spring preload. Turning the screw will cause valve malfunction.

### Inspection

- Be certain that all the hoses are routed without being flattened or kinked, and are connected correctly to the air cleaner housing, vacuum switch valve, #1 and #4 carburetors, and air suction valve covers.
- ★ If they are not, correct them. Replace them if damaged.

Using the vacuum gauge (special tool) and a syringe, inspect the vacuum switch operation as follows:

- Remove the fuel tank.
- Pull the air hose out of the air cleaner housing.
- Slide the hose clamps out of place, and pull the vacuum hoses (2) off the carburetors.
- Connect the vacuum gauge and a syringe to the vacuum hoses.

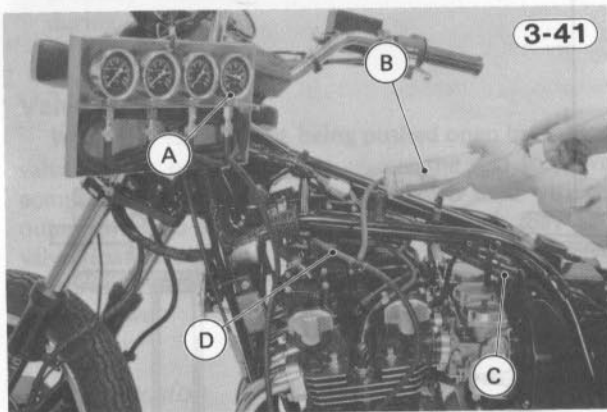

A. Vacuum Gauge: 57001-127

B. Syringe

C. Air Hose

D. Vacuum Hoses

- Gradually raise the vacuum (lower the pressure) applied to the vacuum switch valve, and check the valve operation. When the vacuum is low enough, the vacuum switch valve should permit air to flow. When the vacuum reaches a certain level between 35 and 39 cmHg, it should stop air flow. When the vacuum is high enough, the air cannot also flow through the valve.
- ★ If the vacuum switch valve does not operate as this, replace it with a new one. Adjustment is not permitted.

**NOTE:** 1. Whether the valve permits the air to flow or not is confirmed by blowing the air hose with breath.

#### CAUTION

1. Do not apply a vacuum more than 50 cmHg to the vacuum switch valve as this could damage the diaphragm in the valve.

### Vacuum Switch Valve Operation

3-42

#### 1. During Cruising

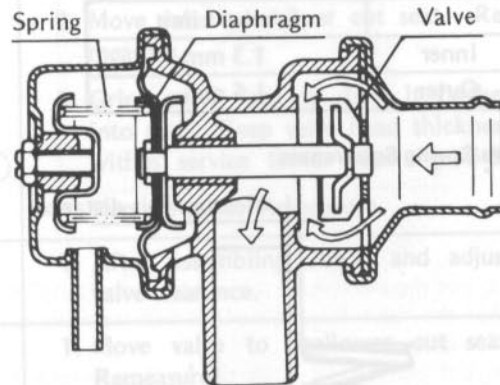

Secondary air flows.

#### 2. During Engine Braking

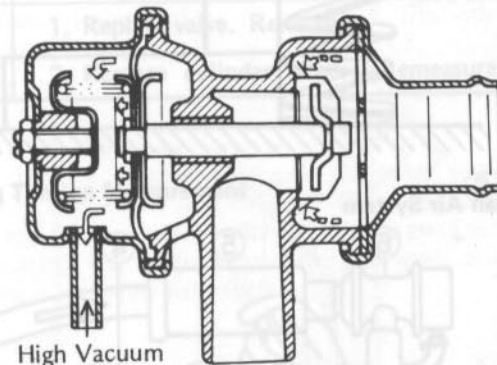

High Vacuum

Secondary air cannot flow.

- Conversely, gradually lower the vacuum (raise the pressure) applied to the vacuum switch valve, and check the valve operation. The valve will return to its original state just the reverse way as it came, but the transition should occur when the vacuum comes to a level between 27 and 31 cmHg.

★ If the valve does not work as specified, replace the valve with a new one.

## CYLINDER BLOCK, PISTONS

Proper inspection and maintenance of the cylinder block and the pistons include checking the compression;

removing carbon from the piston heads, piston ring grooves, and cylinder head exhaust ports; and checking for wear and proper clearance during top end overhaul. A worn cylinder, worn piston, or worn or stuck piston rings may cause a loss of compression from gas blowby past the rings. Blowby may result in difficult starting, power loss, excessive fuel consumption, contaminated engine oil, and possibly engine destruction. Oil leakage into the combustion chambers causes carbon to build up on top of the pistons; which may result in preignition, overheating, and detonation. A worn piston pin causes piston slap, which may cause accelerated piston and cylinder wear. It is evidenced by a knocking sound in the engine.

Engine problems may be caused not only by carbon deposits and wear or damage to the engine itself; but also by poor quality fuel or oil, improper oil, improper fuel/air mixture, improper supply of oil, or incorrect ignition timing. Whenever knocking, pinging, piston slap, or other abnormal engine noise is heard; the cause should be determined as soon as possible. Neglect of proper maintenance will result in reduced engine power and may lead to accelerated wear, overheating, detonation, piston seizure, and engine destruction.

**NOTE:** 1. Whenever a piston or cylinder block has been replaced with a new one, the motorcycle must be broken in the same as with a new machine.

**Compression Measurement**

- Check that the battery is fully charged.
- Thoroughly warm up the engine so that engine oil between the pistons and cylinder walls will help seal compression as it does during normal running. While the engine is running, check that there is no gas leakage from around the cylinder head gasket and from the spark plugs.
- Stop the engine, remove all spark plugs, and attach the compression gauge (special tool) firmly into one spark plug hole.
- Using the starter motor, turn the engine over with the throttle fully open until the compression gauge stops rising; the compression is the highest reading obtainable. Repeat the measurement for the other cylinder.

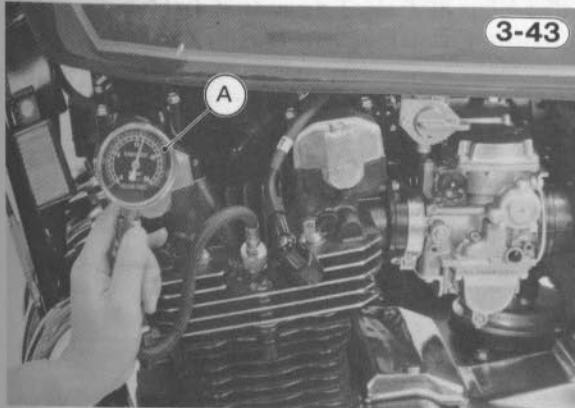

A. Compression Gauge: 57001-123

**Table 3-22 Cylinder Compression**

Standard	Usable Range
11.2 – 13.2 kg/cm <sup>2</sup> (1120 – 1320 kPa, 159 – 188 psi)	8.5 – 13.2 kg/cm <sup>2</sup> (850 – 1320 kPa, 121 – 188 psi), and less than 1 kg/cm <sup>2</sup> (100 kPa, 14 psi) difference between any two cylinders

★ If cylinder compression is higher than the usable range, check the following:

1. Carbon build-up on the piston head and cylinder head – clean off any carbon on the piston head and cylinder head.
2. Cylinder head gasket, cylinder base gasket – use only the proper gasket for the cylinder head. The use of a gasket of incorrect thickness will change the compression.
3. Valve stem oil seals and piston rings – rapid carbon accumulation in the combustion chambers may be caused by damaged valve stem oil seals and/or damaged piston oil rings. This may be indicated by white exhaust smoke.
4. Combustion chamber volume (Pg. 3-7).

★ If cylinder compression is lower than the usable range, check the following:

1. Gas leakage around the cylinder head – replace the damaged gasket and check the cylinder head warp (Pg. 3-7).
2. Condition of the valve seating (Pg. 3-10).
3. Valve clearance (Pg. 2-5).
4. Piston/cylinder clearance, piston seizure.
5. Piston ring, piston ring groove.

**Cylinder Diameter**

• Since there is a difference in cylinder wear in different directions, take a side-to-side and a front-to-back measurement at each of the 3 locations (total of 6 measurements) shown in Fig. 3-44.

★ If any of the cylinder inside diameter measurements exceeds the service limit, the cylinder will have to be bored to oversize and then honed.

**NOTE:** 1. Table 3-23 applies only to a cylinder that has not been bored to oversize. For the service limit of a bored cylinder, see the “Boring, Honing” paragraph.

**Cylinder Diameter Measurement**

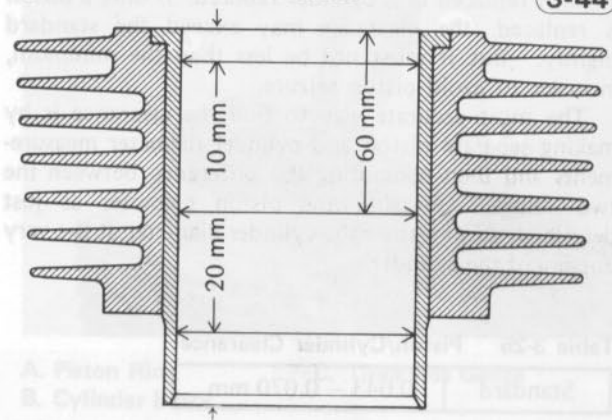

Table 3-23 Cylinder Inside Diameter

Standard	Service Limit
69.400 – 69.412 mm, and less than 0.01 mm difference between any two measurements	69.50 mm, or more than 0.05 mm difference between any two measurements

### Piston Diameter

● Measure the outside diameter of each piston 5 mm up from the bottom of the piston at a right angle to the direction of the piston pin.

★ If the measurement is under the service limit, replace the piston.

**NOTE:** 1. Abnormal wear such as a marked diagonal pattern across the piston skirt may mean a bent connecting rod or crankshaft.

2. Table 3-24 applies only to the standard size piston. For the service limit of a oversize piston, see the "Boring, Honing" paragraph.

Table 3-24 Piston Diameter

Standard	Service Limit
69.342 – 69.357 mm	69.2 mm

### Piston Diameter Measurement

3-45

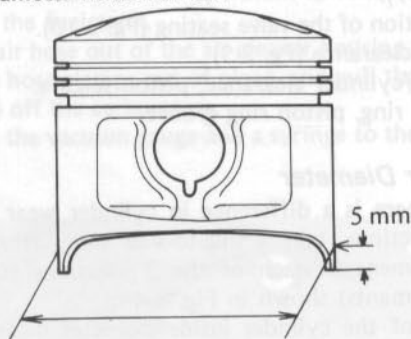

### Piston/Cylinder Clearance

The piston-to-cylinder clearance is measured whenever a piston or the cylinder block is replaced with a new one, or whenever a cylinder is rebored and an oversize piston installed. The standard piston-to-cylinder clearance must be adhered to whenever the cylinder block is replaced or a cylinder rebored. If only a piston is replaced, the clearance may exceed the standard slightly. But it must not be less than the minimum, in order to avoid piston seizure.

The most accurate way to find the clearance is by making separate piston and cylinder diameter measurements and then computing the difference between the two values. Measure the piston diameter as just described, and measure the cylinder diameter at the very bottom of the cylinder.

Table 3-25 Piston/Cylinder Clearance

Standard	0.043 – 0.070 mm

### Boring, Honing

When boring and honing a cylinder, note the following:

1. There are two sizes of oversize pistons available: 0.5 mm and 1.0 mm. Oversize pistons require oversize rings.
2. Before boring a cylinder, first measure the exact diameter of the oversize piston, and then, in accordance with the standard clearance given in Table 3-25, determine the diameter of the rebore. However, if the amount of boring necessary would make the inside diameter greater than 1.0 mm, the cylinder block must be replaced.
3. To avoid cylinder distortion due to unbalanced metal temperatures, bore the cylinders in 2-4-1-3 or 3-1-4-2 order.
4. Cylinder inside diameter must not vary more than 0.01 mm at any point.
5. Be wary of measurements taken immediately after boring since the heat affects cylinder diameter.
6. In the case of a rebored cylinder and oversize piston, the service limit for the cylinder is the diameter that the cylinder was bored to plus 0.1 mm and the service limit for the piston is the oversize piston original diameter minus 0.15 mm. If the exact figure for the rebored diameter is unknown, it can be roughly determined by measuring the diameter at the base of the cylinder.

### Piston/Cylinder Seizure

● Remove the cylinder block and pistons to check the damage.

★ If there is only slight damage, the piston may be smoothed with #400 emery cloth, and any aluminum deposits removed from the cylinder with either #400 emery cloth or light honing. However, in most cases, the cylinder will have to be bored to oversize and honed, and an oversize piston installed.

### Piston Cleaning

Built-up carbon on the piston head reduces the cooling capability of the piston and raises compression, leading to overheating which could possibly even melt the top of the piston.

● Remove the piston, scrape off the carbon, and then lightly polish the piston with fine emery cloth.



3-46

Carbon accumulated in the piston ring grooves can cause the rings to stick.

- Remove the rings, and clean out any carbon deposits using an end of a broken piston ring or some other suitable tool.

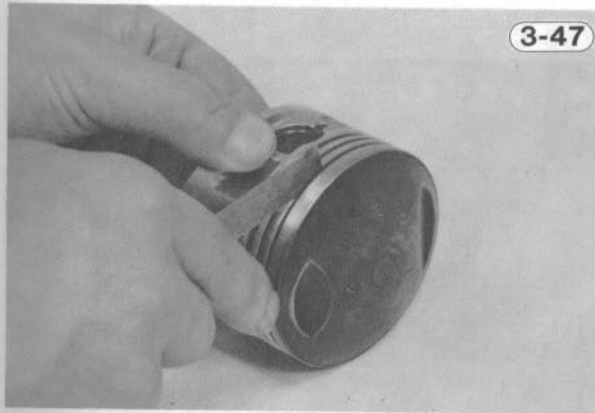

3-47

- CAUTION**
1. When removing carbon, take ample care not to scratch the side of the piston, or the piston ring grooves.
  2. Never clean the piston heads with the engine assembled. If the carbon is scraped from the piston heads with the cylinder left in place, carbon particles will unavoidably drop between the pistons and cylinder walls onto the rings and eventually find their way into the crank chamber. Carbon particles, which are very abrasive, drastically shorten the life of the rings, pistons, cylinders, crankshaft bearings, and oil seals.

#### Piston Ring, Piston Ring Groove Wear

- Check for uneven groove wear by inspecting the ring seating.
- ★ The rings should fit perfectly parallel to the groove surfaces. If not, the piston must be replaced.
- With the piston rings in their grooves, make several measurements with a thickness gauge to determine piston ring/groove clearance.
- ★ If the clearance exceeds the service limit, remove the piston rings, and measure the thickness of the piston rings and the width of the ring grooves. If the ring has worn down to less than the service limit, replace the ring; if the groove width exceeds the service limit, replace the piston.

**NOTE:** 1. Table 3-26 through Table 3-28 apply to over-size pistons and rings as well as standard pistons and rings.

**Table 3-26 Piston Ring/Groove Clearance**

	Standard	Service Limit
Top	0.030 – 0.070 mm	0.17 mm
2nd	0.020 – 0.060 mm	0.16 mm

**Table 3-27 Piston Ring Thickness**

	Standard	Service Limit
Top	0.970 – 0.990 mm	0.90 mm
2nd	1.170 – 1.190 mm	1.10 mm

**Table 3-28 Piston Ring Groove Width**

	Standard	Service Limit
Top	1.02 – 1.04 mm	1.12 mm
2nd	1.21 – 1.23 mm	1.31 mm
Oil	2.51 – 2.53 mm	2.61 mm

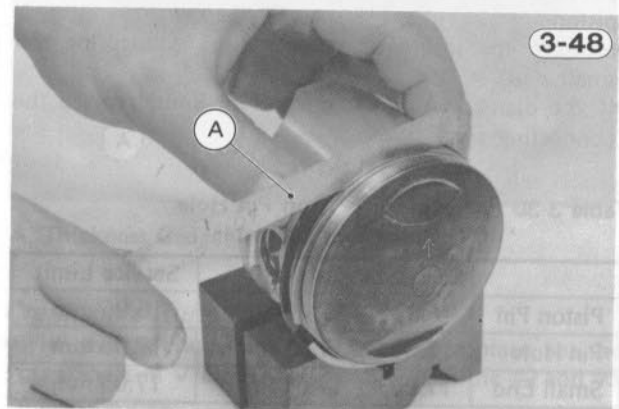

3-48

#### A. Thickness Gauge

- Remove the piston rings from the piston.
- Visually inspect the piston rings and the piston ring grooves.
- ★ If the rings are worn unevenly or damaged, they must be replaced.
- ★ If the piston ring grooves are worn unevenly or damaged, the piston must be replaced and fitted with new rings.

#### Piston Ring End Gap

- Place the piston ring inside the cylinder, using the piston to locate the ring squarely in place. Set it close to the bottom of the cylinder, where cylinder wear is low.
- Measure the gap between the ends of the ring with a thickness gauge.
- ★ If the gap is wider than the service limit, the ring is overworn and must be replaced.

**Table 3-29 Ring End Gap**

Standard	Service Limit
0.20 – 0.40 mm	0.7 mm

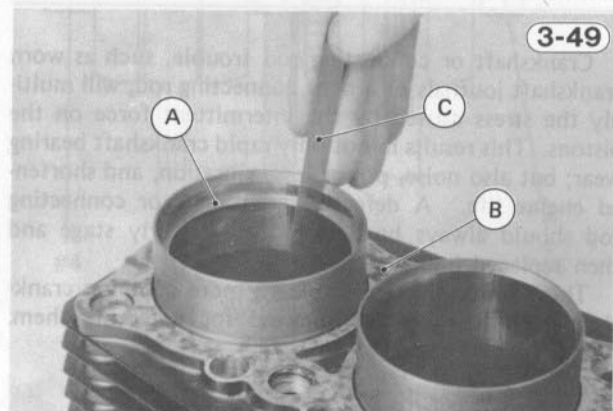

3-49

A. Piston Ring  
B. Cylinder Block

C. Thickness Gauge

**Piston, Piston Pin, Connecting Rod Wear**

- Measure the diameter of the piston pin with a micrometer, and measure the inside diameter of both piston pin holes in the piston.
- ★ If the piston pin diameter is less than the service limit at any point, replace the piston pin. If either piston pin hole diameter exceeds the service limit, replace the piston.
- Measure the inside diameter of the connecting rod small end.
- ★ If the diameter exceeds the service limit, replace the connecting rod.

**Table 3-30** Piston Pin, Piston Pin Hole Small End Diameter

	Standard	Service Limit
Piston Pin	16.995 – 17.000 mm	16.96 mm
Pin Hole	17.004 – 17.011 mm	17.08 mm
Small End	17.003 – 17.014 mm	17.05 mm

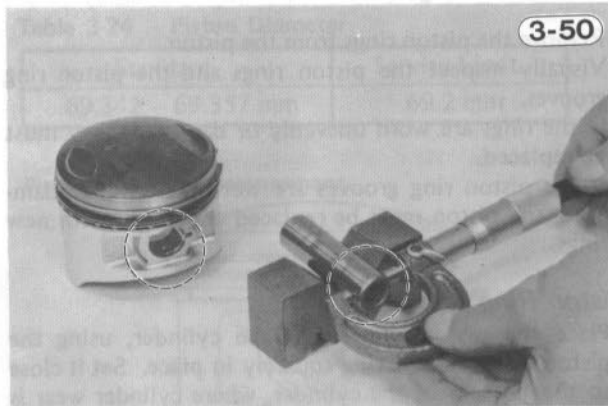

3-50

**CRANKSHAFT, CONNECTING RODS**

Crankshaft or connecting rod trouble, such as worn crankshaft journals or a bent connecting rod, will multiply the stress caused by the intermittent force on the pistons. This results in not only rapid crankshaft bearing wear; but also noise, power loss, vibration, and shortened engine life. A defective crankshaft or connecting rod should always be detected at an early stage and then replaced immediately.

This manual lists some of the more common crankshaft troubles and the method for detecting them.

**Connecting Rod Bending or Twisting**

- With the crankshaft main bearings in place, set the crankshaft in V blocks on a surface plate.

- Select an arbor of the same diameter as the piston pin and of optional length, and insert it into the small end of the connecting rod.
- Use a height gauge or dial gauge and measure the difference in height over a 100 mm length to determine the amount the connecting rod is bent.

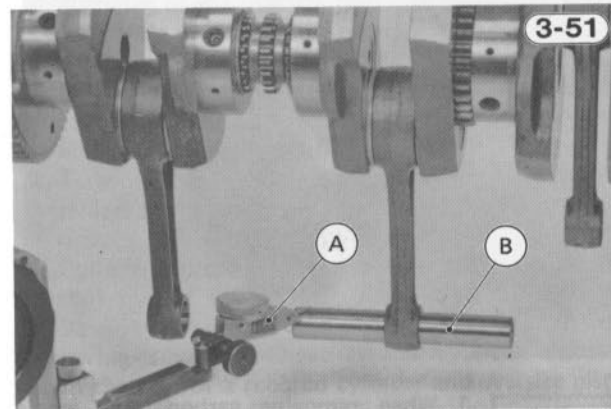

A. Height Gauge

B. Arbor

- Using the arrangement and arbor shown below, measure the amount that the arbor varies from being parallel with the crankshaft, over a 100 mm length of the arbor.
- ★ If either of the above measurements exceeds the service limit, the crankshaft assembly should be replaced.

**Table 3-31** Connecting Rod Bend, Twist/100 mm

Standard	Service Limit
under 0.05 mm	0.2 mm

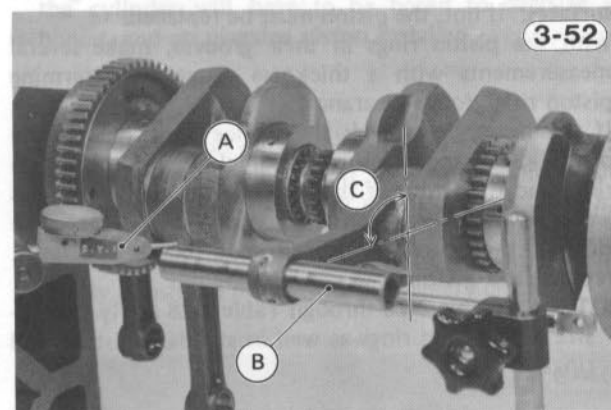

A. Height Gauge

B. Arbor

C. 90°

**Connecting Rod Big End Radial Clearance**

- Set a dial gauge against the big end of the connecting rod, and first push the connecting rod toward the gauge and then in the opposite direction. The difference between the two gauge readings is the radial clearance.
- ★ If radial clearance exceeds the service limit, the crankshaft assembly should be replaced.

Table 3-32 Connecting Rod Big End Radial Clearance

Standard	Service Limit
0.016 – 0.030 mm	0.08 mm

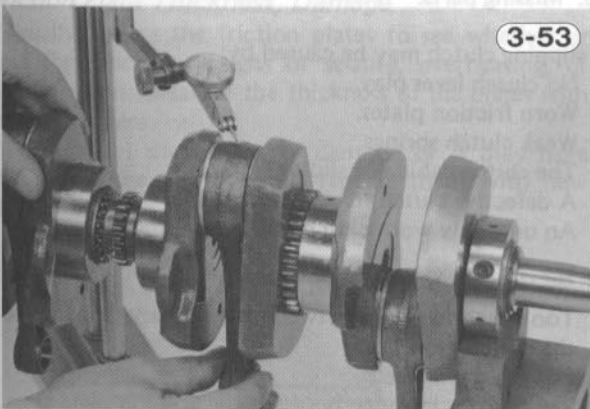

**Connecting Rod Side Clearance**

- Measure the side clearance of the connecting rod with a thickness gauge as shown.
- \* Replace the crankshaft if the clearance exceeds the service limit.

Table 3-33 Connecting Rod Big End Side Clearance

Standard	Service Limit
0.30 – 0.40 mm	0.6 mm

**Crankshaft Runout Measurement**

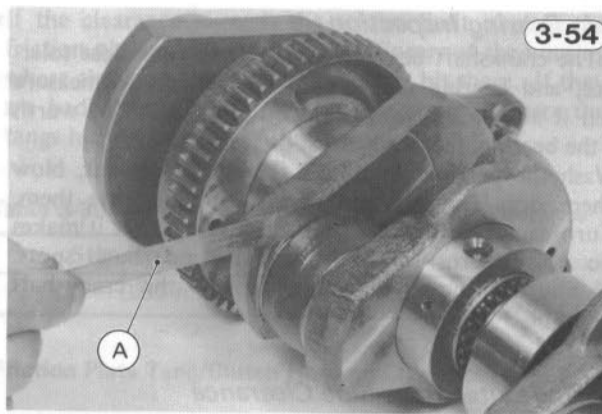
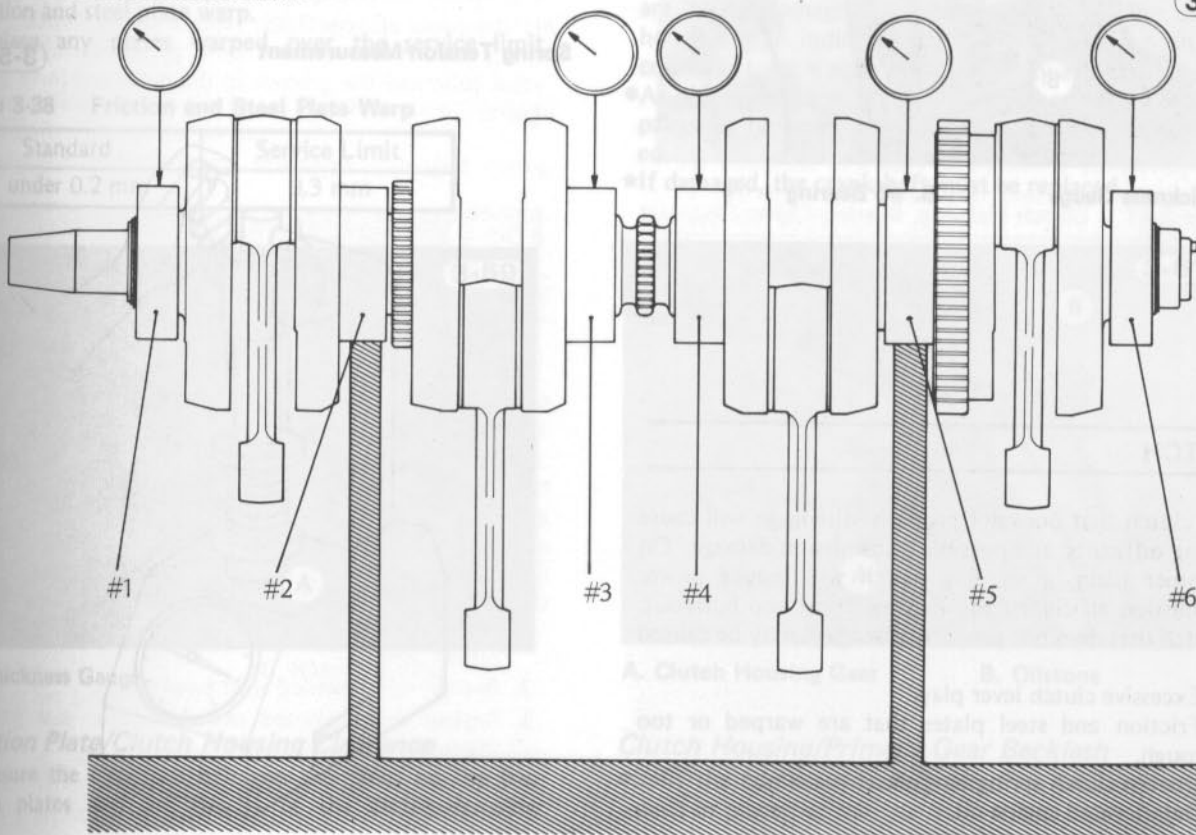

A. Thickness Gauge

**Crankshaft Runout**

- With the six crankshaft main bearings in place, set the crankshaft in V blocks, suspending it at the #2 and #5 main bearings.
- Set a dial gauge against each of the other bearings and turn the crankshaft slowly. The difference between the highest and lowest dial gauge readings for the bearing is the runout.
- \* If runout measured at any bearing exceeds the service limit, the crankshaft should be replaced.

Table 3-34 Crankshaft Runout

Standard	Service Limit
under 0.04 mm	0.10 mm

### Main Bearing Inspection

The crankshaft bearings are made to very close tolerance, and bearing play would be difficult to measure even if all the bearings could be removed. The worth of the bearing, therefore, must be judged by feel.

- Wash the bearings in a high flash-point solvent, blow them dry (**Do not spin them**), and lubricate them.
- Turn each bearing over by hand and see that it makes no noise, turns smoothly, and has no rough spots.
- ★ If any bearing is defective, replace the crankshaft assembly.

### Bearing Outer Race Side Clearance

The #5 bearing outer race works not only as a bearing outer race but also as a stopper of crankshaft axial movement (thrust bearing).

- Measure the clearance with a thickness gauge as shown.
- ★ Replace the crankshaft, if the clearance exceeds the service limit.

Table 3-35 Outer Race Side Clearance

Standard	Service Limit
0.2 – 0.3 mm	0.5 mm

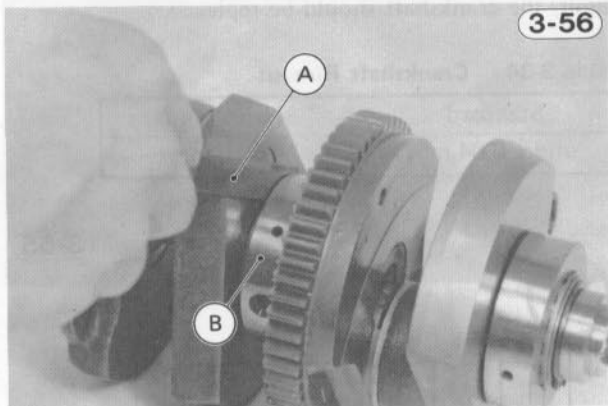

3-56

A. Thickness Gauge

B. #5 Bearing

## CLUTCH

A clutch that does not properly disengage will cause shifting difficulty and possible transmission damage. On the other hand, a slipping clutch will reduce power transmission efficiency and may overheat and burn out. A clutch that does not properly disengage may be caused by:

1. Excessive clutch lever play.
2. Friction and steel plates that are warped or too rough.
3. Uneven clutch spring tension.
4. Deteriorated engine oil.

5. Engine oil viscosity too high.
6. Engine oil level too high.
7. The clutch housing frozen on the drive shaft.
8. A defective clutch release mechanism.
9. An unevenly worn clutch hub or housing.
10. Missing parts.

A slipping clutch may be caused by:

1. No clutch lever play.
2. Worn friction plates.
3. Weak clutch springs.
4. The clutch cable not sliding smoothly.
5. A defective clutch release mechanism.
6. An unevenly worn clutch hub or housing.

Clutch noise may be caused by:

1. Too much backlash between the primary gear and the the clutch gear.
2. Damaged gear teeth.
3. Too much clearance between the friction plate tangs and the clutch housing.
4. Clutch housing bearing worn or damaged.
5. Weak or damaged damper spring(s).
6. Metal chips jammed into the clutch housing gear teeth.

### Spring Tension

- Remove the springs, and set them, one at a time, on a spring tension testing device.
- Compress the spring to the specified test length, and read the spring tension.
- ★ If the spring tension at the specified length is weaker than the service limit, replace the spring.

### Spring Tension Measurement

3-57

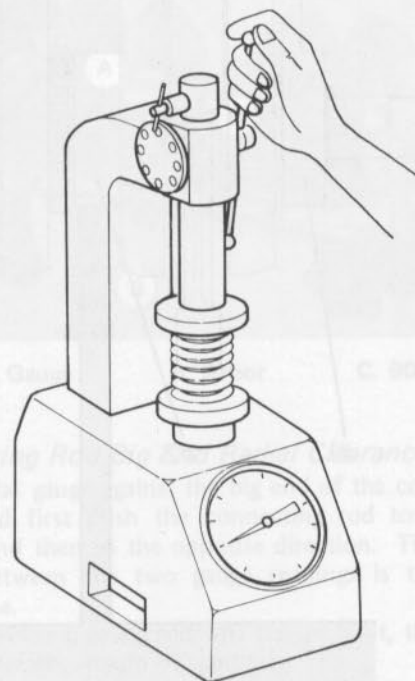



Table 3-36 Clutch Spring Tension

Test Length	Standard	Service Limit
23.5 mm	23.5 – 26.5 kg	22.5 kg

**Friction Plate Thickness, Damage**

●Visually inspect the friction plates to see whether or not they show any signs of seizure, overheating, or uneven wear. Measure the thickness of the plates with vernier calipers.

★If any plates show signs of damage, or if they have worn past the service limit, replace them with new ones.

**Friction Plate Measurement**

3-58

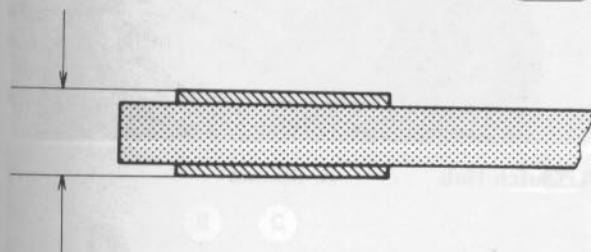

Table 3-37 Friction Plate Thickness

Standard	Service Limit
2.9 – 3.1 mm	2.8 mm

**Friction and Steel Plate Warp**

●Place each friction and steel plate on a surface plate, and measure the gap between each friction and steel plate and the surface plate. This gap is the amount of friction and steel plate warp.

★Replace any plates warped over the service limit.

Table 3-38 Friction and Steel Plate Warp

Standard	Service Limit
under 0.2 mm	0.3 mm

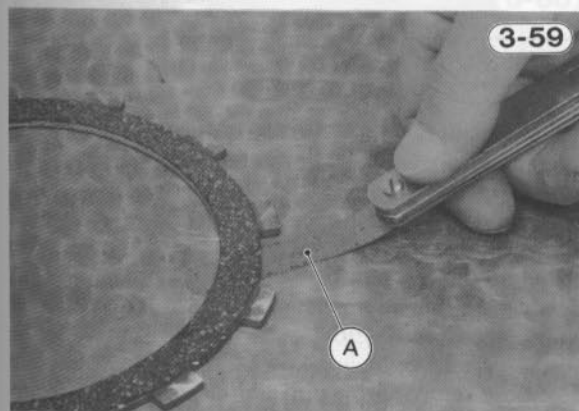

3-59

A. Thickness Gauge

**Friction Plate/Clutch Housing Clearance**

●Measure the clearance between the tangs on the friction plates and the fingers of the clutch housing.

★If the clearance exceeds the service limit, replace the friction plates. Also, inspect the fingers of the housing where the tangs of the friction plates hit them. If they are badly worn or if there are grooves cut where the tangs hit, replace the clutch housing.

Table 3-39 Friction Plate/Clutch Housing Clearance

Standard	Service Limit
0.35 – 0.65 mm	0.9 mm

**Friction Plate Tang/Clutch Housing Clearance**

3-60

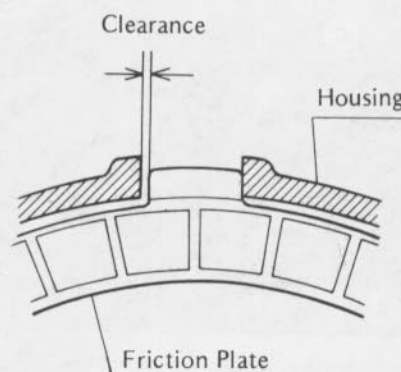
**Clutch Housing Gear Inspection**

●Inspect the teeth on the clutch housing gear.

★Any light damage can be corrected with an oilstone, but the clutch housing must be replaced if the teeth are badly damaged. Damaged teeth on the clutch housing gear indicate that the primary gear on the crankshaft, by which it is driven, may also be damaged.

●At the same time that the clutch housing gear is repaired or replaced, the primary gear should be inspected.

★If damaged, the crankshaft must be replaced.

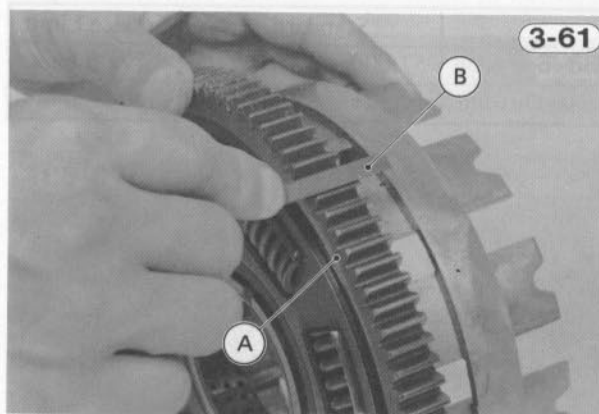

3-61

A. Clutch Housing Gear

B. Oilstone

**Clutch Housing/Primary Gear Backlash**

●Split the crankcase leaving the drive shaft and crankshaft in place.

- Set a dial gauge against the teeth of one gear, and move the gear back and forth while holding the other gear steady. The difference between the highest and the lowest gauge reading is the amount of backlash.
- ★Replace both the clutch housing and the crankshaft wherever the amount of backlash exceeds the service limit.

**Table 3-40 Clutch Housing Gear/Primary Gear Backlash**

Standard	Service Limit
0.03 – 0.10 mm	0.14 mm

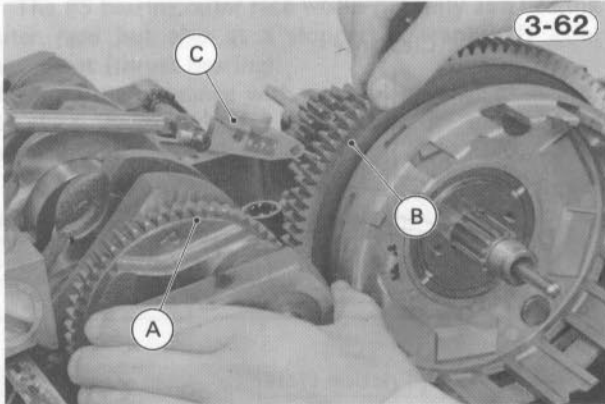

**A. Primary Gear                      C. Dial Gauge**  
**B. Clutch Housing Gear**

**Clutch Housing, Bearing Collar Diameter**

- Measure the outside diameter of the clutch housing bearing collar with a micrometer.
- ★Replace the bearing collar if the diameter is less than the service limit.
- Measure the inside diameter of the clutch housing with a cylinder gauge.
- ★Replace the clutch housing if the diameter exceeds the service limit.

**Table 3-41 Clutch Housing, Bearing Collar Diameter**

	Standard	Service Limit
Housing Inside	57.000 – 57.030 mm	57.06 mm
Collar Outside	56.921 – 56.940 mm	56.90 mm

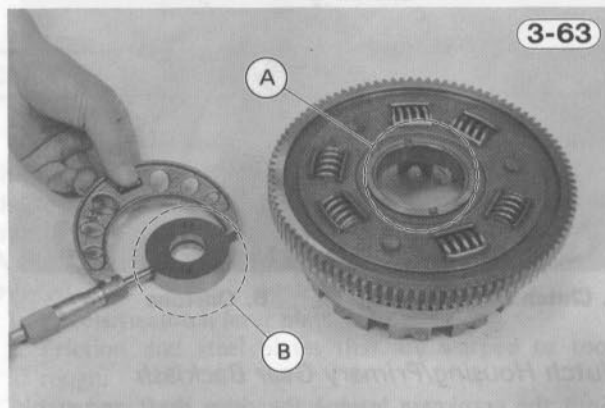

**A. Clutch Housing                      B. Bearing Collar**

**Clutch Hub Damage**

- Inspect where the teeth on the steel plates wear against the splines of the clutch hub.
- ★If there are notches worn into the splines, replace the clutch hub.

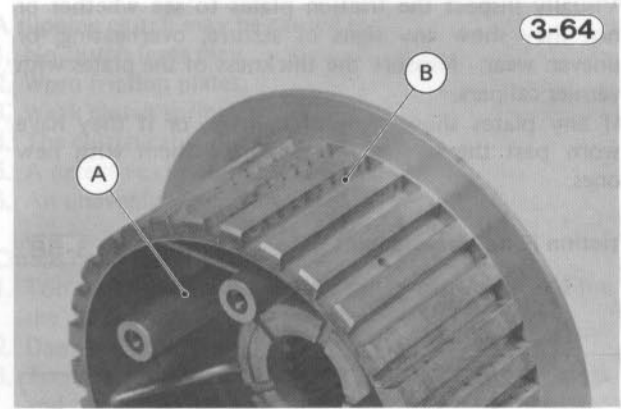

**A. Clutch Hub                      B. Splines**

**Clutch Release Inspection**

- With the clutch release assembled, push the inner worm gear back and forth in the direction of the shaft without turning it.
- ★If there is excessive play, replace the clutch release assembly.
- Turning the clutch release lever by hand, check that the lever moves smoothly without binding.
- ★If there is any rough spot in the lever action, disassemble the clutch release, wash the parts in a high flash-point solvent, and visually inspect them.
- ★If the parts are damaged, replace them. When assembling the clutch release, apply grease liberally to the steel balls and the grooves in the outer and inner worm gears.

**TRANSMISSION, SHIFT MECHANISM**

For simplicity, the drive shaft gears in the following explanation are referred to as "D" (e.g. D1=drive shaft 1st gear) and the output shaft gears as "O".

Transmission or shift mechanism damage, causing the transmission to misshift, overshift, and/or jump out of gear, brings about more damage to the transmission and also overrev damage to the engine itself. An improperly functioning transmission or shift mechanism may be caused by the following:

1. Loose return spring pin, and/or broken or weakened return spring.
2. Broken or weakened shift pawl spring.
3. Broken or weakened neutral and/or gear set lever springs.
4. Damaged shift mechanism arm and/or overshift limiter.

5. Loose shift drum bearing holder.
6. Bent or worn shift fork(s).
7. Worn shift fork grooves on gears D3, O4, and/or O5.
8. Worn shift fork guide pin(s).
9. Worn shift drum groove(s).
10. Binding of neutral and/or gear set levers.
11. Worn or damaged gear dogs, gear dog holes, and/or gear dog recesses.
12. Improper functioning clutch or clutch release.
13. Improper assembly or missing parts.

Transmission noise results from worn or damaged shafts, bearings, gear hubs or teeth, etc.

**Shift Mechanism:**

*External Shift Mechanism Inspection*

- Remove the engine, and split the crankcase.
- Inspect the shift pawl spring, shift pawls, and overshift limiter.
- ★ Replace any broken or otherwise damaged parts.

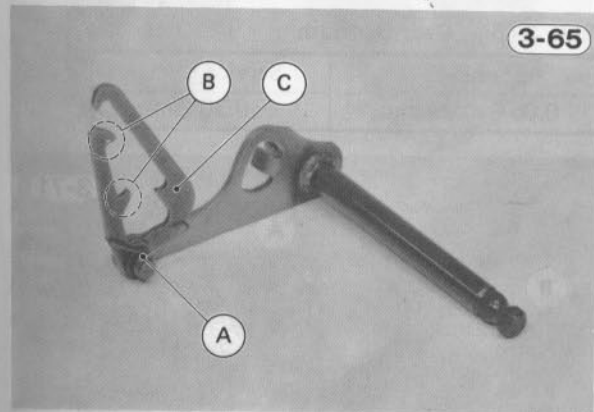

A. Shift Pawl Spring      C. Overshift Limiter  
B. Shift Pawls

- Visually inspect the neutral and gear set lever springs, and shift shaft return spring.
- ★ Replace any broken or otherwise damaged spring.

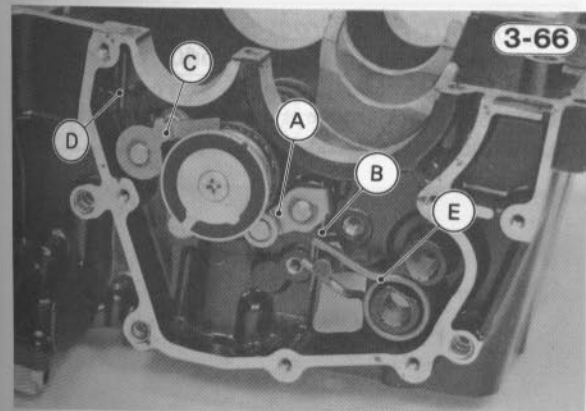

A. Neutral Set Lever      D. Spring  
B. Spring      E. Return Spring  
C. Gear Set Lever

- Check to see if the neutral and gear set levers pivot smoothly without binding and snap into place by spring tension.

- ★ If they do not, check to see if the springs and set levers are correctly installed.
- ★ If the springs and set levers are correctly installed but they do not pivot smoothly, remove the set levers and inspect their pivots. Replace any damaged part.
- Check to see if the return spring pin is loose.
- ★ If it is, remove it and apply a non-permanent locking agent to the threads. Then screw it back in, tightening it to 2.0 kg-m (14.5 ft-lbs) of torque.
- Check to see if the shift drum bearing holder is loose.
- ★ If it is, tighten the holder mounting screws securely.

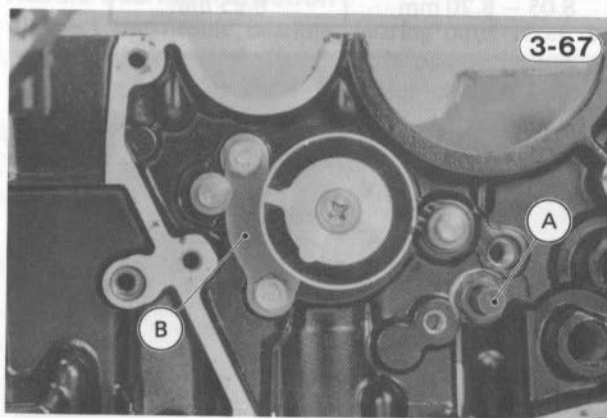

A. Return Spring Pin      B. Shift Drum Bearing Holder

*Shift Drum, Shift Fork, Shift Rod Inspection*

- Remove the shift rods, forks, and drum.
- Visually inspect the shift rods.
- ★ If they are badly worn or if they show stepped wear, replace the shift rods and forks.
- Visually inspect the shift forks.
- ★ Replace any fork that is bent. A bent fork could cause difficulty in shifting or allow the transmission to jump out of gear when under power.
- Measure the thickness of the ears of each shift fork, and measure the diameter of each shift fork guide pin.
- ★ If the thickness of a shift fork is under the service limit or if the guide pin has worn past the service limit, replace the shift fork.

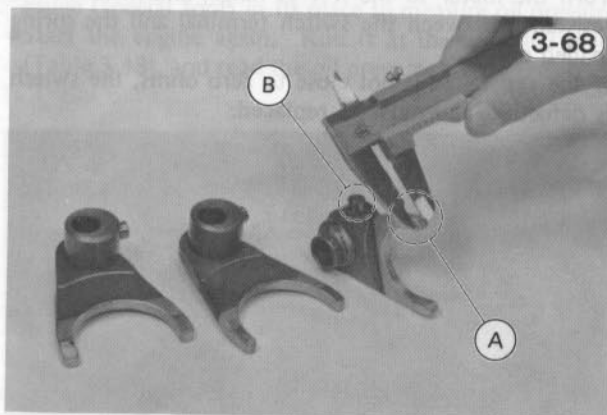

A. Ear      B. Guide Pin

**Table 3-42 Shift Fork Ear Thickness**

Standard	Service Limit
5.9 – 6.0 mm	5.8 mm

**Table 3-43 Shift Fork Guide Pin Diameter**

Standard	Service Limit
7.990 – 8.005 mm	7.94 mm

- Measure the width of each shift drum groove.
- ★ If a shift drum groove is worn past the service limit, replace the shift drum.

**Table 3-44 Shift Drum Groove Width**

Standard	Service Limit
8.05 – 8.20 mm	8.25 mm

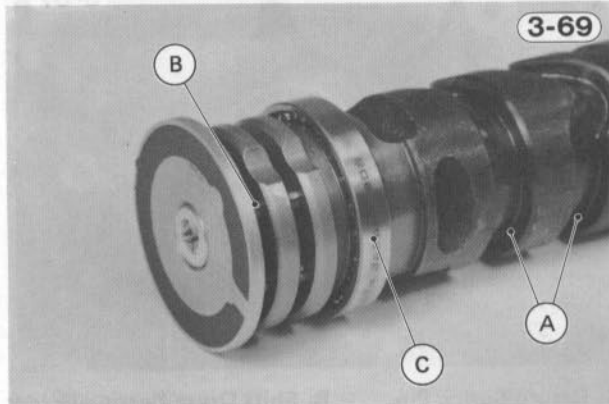

A. Shift Drum Grooves      C. Ball Bearing  
B. Pin

- Visually inspect the shift drum pins, pin holder, and pin plate.
- ★ If they are badly worn or if they show any damage, replace them.
- Spin the shift drum ball bearing by hand to check its condition.
- ★ If it is noisy, does not spin smoothly, or has any rough spots, replace it.

**Neutral Switch Inspection**

- Remove the switch from the external shift mechanism cover.
- Turn the meter to the  $\times 1 \Omega$  range, and measure the resistance between the switch terminal and the spring loaded pin.
- ★ If the resistance is not close to zero ohms, the switch is defective, and must be replaced.

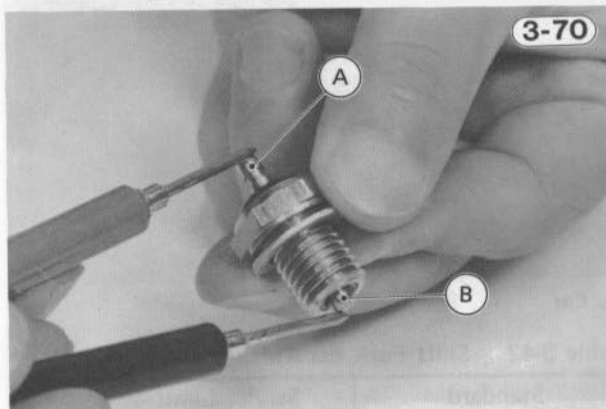

A. Switch Terminal      B. Spring Loaded Pin

- If the resistance is close to zero ohms, measure the resistance between the switch terminal or spring loaded pin and the switch body.
- ★ If there is any meter reading, the neutral switch is defective and must be replaced.
- If the neutral indicator does not go on in the neutral position and it does go on in other positions, check to see that the shift drum pin plate is correctly installed in the bearing holder. Refer to the "Disassembly" chapter for installation information.

**Transmission:**

**Gear Backlash**

- Split the crankcase leaving the transmission in place.
- Set a dial gauge against the teeth on one gear, and move the gear back and forth while holding the other gear steady. The difference between the highest and the lowest gauge readings is the amount of backlash.
- ★ Replace both gears if the amount of backlash exceeds the service limit.

**Table 3-45 Gear Backlash**

Standard	Service Limit
0.06 – 0.23 mm	0.30 mm

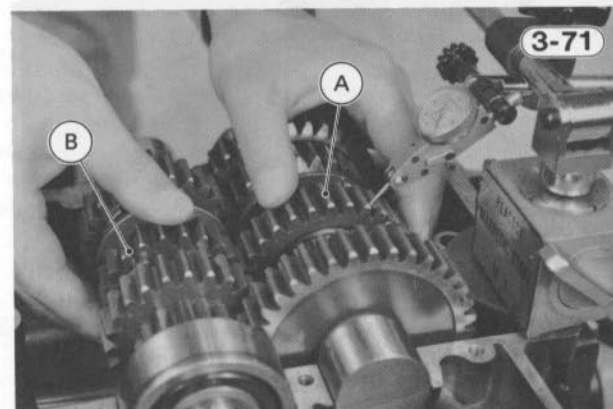

A. Move back and forth lightly.      B. Hold steady.

**Width of Shift Fork Grooves on Gears**

- Measure the width of the shift fork grooves on gears D3, O4, and O5.
- ★ If a gear shift fork groove is worn over the service limit, the gear must be replaced.

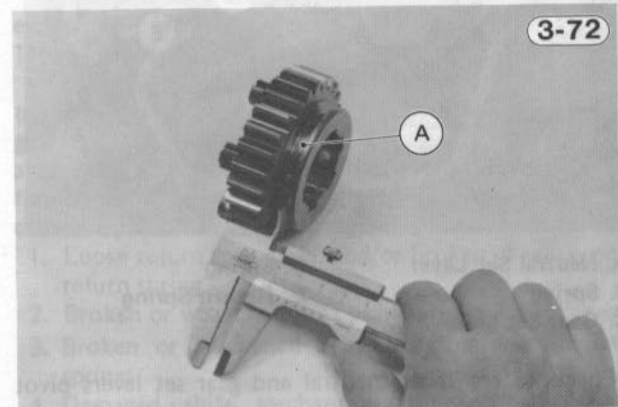

A. Gear Shift Fork Groove

Table 3-46 Width of Shift Fork Groove on Gears

Standard	Service Limit
6.05 – 6.15 mm	6.25 mm

**Gear Dog and Gear Dog Recess Damage**

- Visually inspect the gear dog, and gear dog recesses.
- ★Replace any gears that have damaged, unevenly or excessively worn dog, or dog recesses.

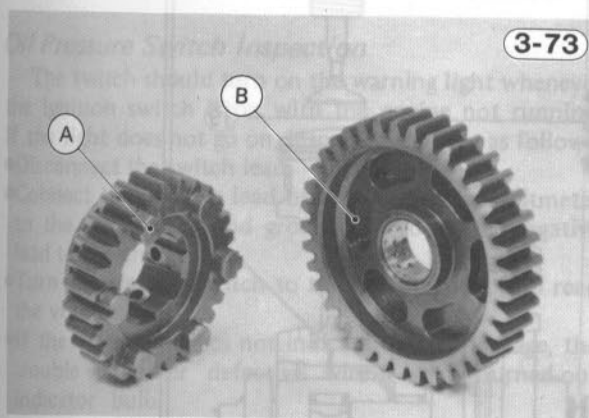

A. Gear Dog

B. Dog Recess

**Gear/Shaft Clearance**

- Measure the diameter of each shaft and bushing with a micrometer, and measure the inside diameter of each gear listed below.
- Find the difference between the two readings to figure clearance.
- ★Replace any gear and bushing where clearance exceeds the service limit.

Table 3-47 Gear/Shaft, Gear Bushing Clearance

	Standard	Service Limit
O1	0.027 – 0.061 mm	0.16 mm
O2, D5	0.025 – 0.075 mm	0.17 mm
O3, D4	0.020 – 0.062 mm	0.16 mm

**Ball Bearing Inspection**

Since the ball bearings are made to extremely close tolerances, the wear must be judged by feel rather than by measurement.

- Clean each bearing in a high flash-point solvent, dry it (**Do not spin it while it is dry**), and oil it. Spin it by hand to check its condition.
- ★If it is noisy, does not spin smoothly, or has any rough spots, replace it.

**Needle Bearing Inspection**

- Inspect the needle bearings, bearing outer races, and drive and output shafts where it passes through the needle bearing for abrasions, color change, or other damage.
- ★If there is any doubt as to the condition of them, replace them.

**ENGINE LUBRICATION SYSTEM****Oil Pressure Measurement**

- Warm up the engine.
- Stop the engine, remove the oil passage plug from the right side of the crankcase, and connect an oil pressure gauge (special tool) in its place to measure oil pressure.
- Start the engine again. Run it at the specified speed (Table 3-48), and read the oil pressure gauge.

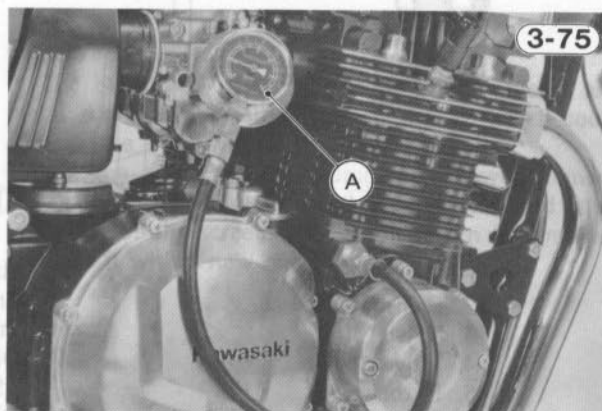

A. Oil Pressure Gauge: 57001-125

Engine Lubrication System

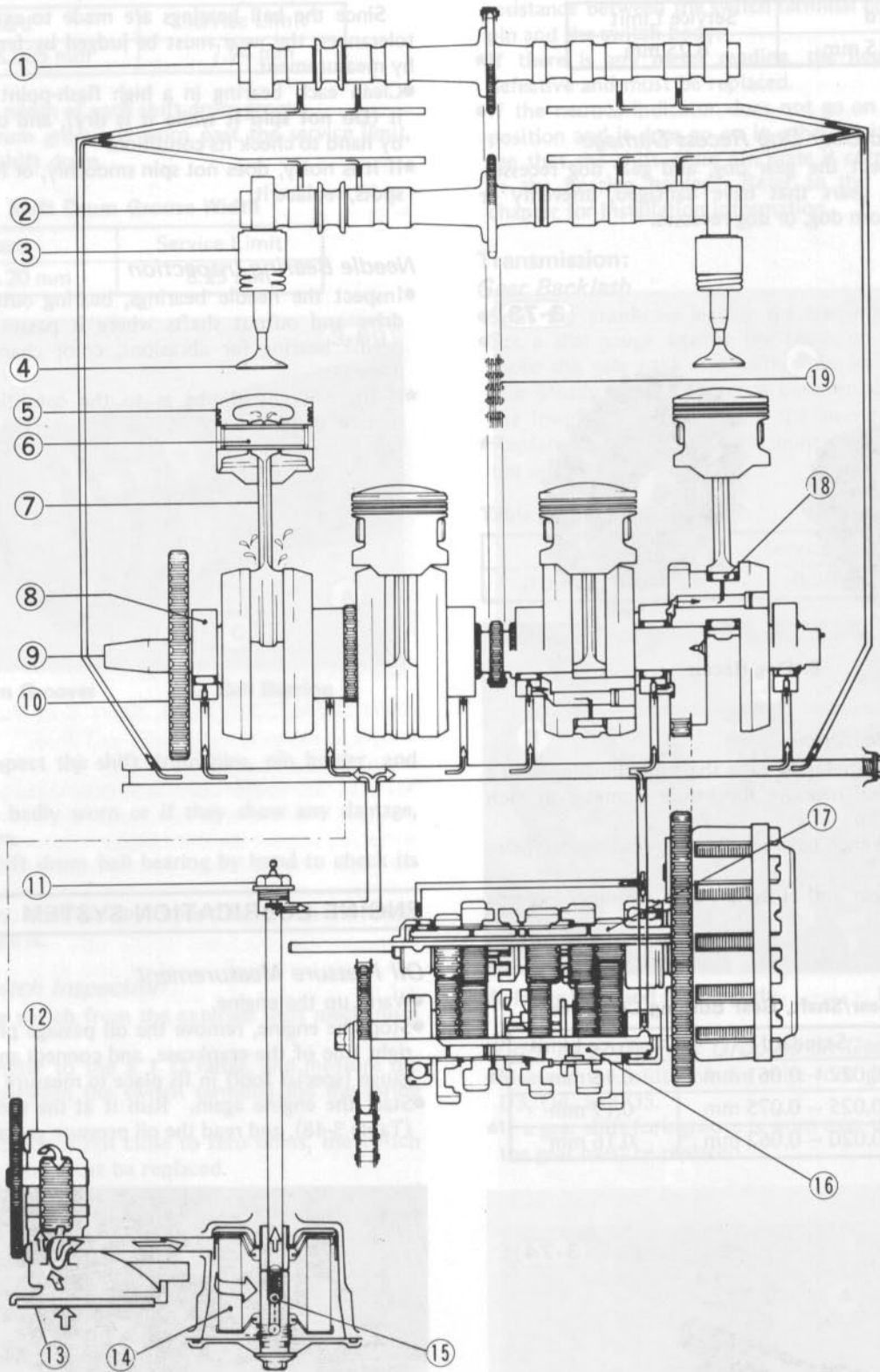

- |                   |                         |                     |
|-------------------|-------------------------|---------------------|
| 1. Camshaft       | 8. Main Bearing         | 14. Oil Filter      |
| 2. Camshaft       | 9. Crankshaft           | 15. Bypass Valve    |
| 3. Valve Lifter   | 10. Starter Gear        | 16. Output Shaft    |
| 4. Valve          | 11. Oil Pressure Switch | 17. Drive Shaft     |
| 5. Piston         | 12. Oil Pump            | 18. Big End Bearing |
| 6. Piston Pin     | 13. Oil Screen          | 19. Camshaft Chain  |
| 7. Connecting Rod |                         |                     |

Table 3-48 Oil Pressure

Oil Pressure @3,000 rpm, 60°C (140°F)
About 0.2 kg/cm <sup>2</sup> (20 kPa, 2.8 psi)

★If the oil pressure is significantly below the standard pressure when the oil temperature is at or below the specified temperature, inspect the engine oil pump. If the pump is not at fault, inspect the rest of the lubrication system.

**Oil Pressure Switch Inspection**

The switch should turn on the warning light whenever the ignition switch is on with the engine not running. If the light does not go on, inspect the wiring as follows.

- Disconnect the switch lead.
- Connect the positive lead of a 25V DC range voltmeter to the switch lead and ground the voltmeter negative lead to the engine.
- Turn the ignition switch to the ON position, and read the voltmeter.
- ★If the voltmeter does not indicate battery voltage, the trouble is either defective wiring or a burned-out indicator bulb.

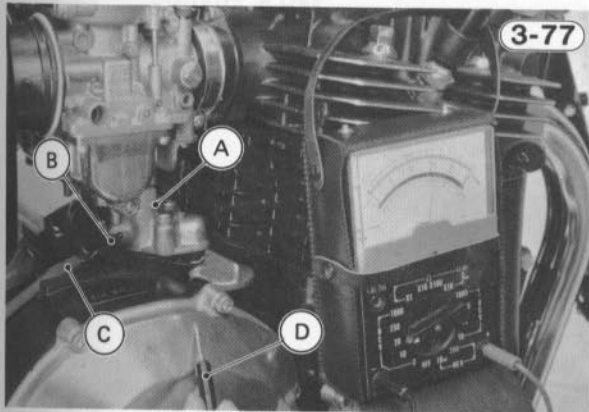

A. Oil Pressure Switch  
B. Switch Lead  
C. Meter + Lead  
D. Meter - Lead

★If the voltmeter does indicate battery voltage, then the oil pressure switch may be defective. Use an ohmmeter to check for continuity between the switch terminal and the engine.

★Any reading other than zero ohms indicates that the switch is at fault.

The switch should turn off the warning light whenever the engine is running faster than the specified speed. If the light stays on, inspect the switch as follows.

- Stop the engine.
- Connect the ohmmeter between the switch terminal and the engine (chassis ground).
- The meter should read zero ohms when the engine is off and infinity when the engine is running above the specified speed (Table 3-49).

★If the meter reads zero ohms when the engine is running at the specified speed, stop the engine and measure the oil pressure. If the oil pressure is more than the specified value with the engine running at the specified speed, the oil pressure switch is defective, and must be replaced.

Table 3-49 Oil Pressure Switch Inspection

Meter	Engine Speed	Oil Pressure Switch
x 1 Ω	Stopped	ON (Ohmmeter reads zero ohms)
	More than 1,300 rpm	OFF (Ohmmeter reads infinity)

**Engine Oil Pump:**

**Pump Gear/Pump Body Clearance**

- Remove and disassemble the oil pump, and re-assemble the internal gears in one side of the pump body.
- With thickness gauges, measure the minimum clearance between each gear and the body.
- ★If the clearance is over the service limit or if the gears are damaged, replace the pump as an assembly.

Table 3-50 Pump Gear/Pump Body Clearance

Standard	Service Limit
0.011 – 0.083 mm	0.14 mm

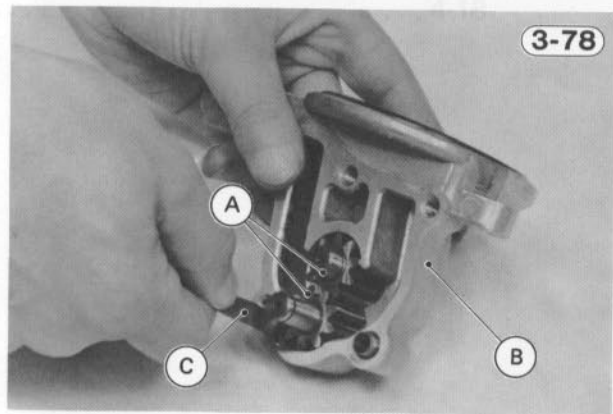

A. Pump Gears  
B. Pump Body  
C. Thickness Gauge

**Oil Screen Inspection**

The oil screen at the oil pump inlet, removes any metal particles and other foreign matter which could damage the oil pump.

- When the oil pan and/or pump are removed, remove the oil screen, and clean any metal particles and other dirt out of the screen. If the oil screen is damaged, replace it with a new one.

# Non-scheduled Maintenance – Chassis

## Table of Contents

WHEELS .....	4-2
SPROCKETS .....	4-8
BRAKES .....	4-8
STEERING .....	4-13
FRONT FORK .....	4-13
REAR SHOCK ABSORBERS .....	4-15
SWING ARM .....	4-18
DRIVE CHAIN .....	4-18

**Wheel Balance**

The front and rear wheels must be kept balanced. Check and balance the wheels when you install a new tire or when the tire is worn.

Remove the wheel.

For a wire spoke wheel, check that the spokes are tightened evenly and the rim is true to within the service limit (Fig. 2-23).

Suspend the wheel so that it can spin freely.

Spin the wheel lightly and observe the wobble. If the wobble is excessive, the wheel is out of balance. To balance the wheel, use a balance weight. For a wire spoke wheel, use a balance weight on the rim. For a tube-type wheel, use a balance weight on the hub.

**A. Use a balance weight.**

**B. Use a rubber weight.**

Use a balance weight on the rim of a wire spoke wheel. The weight should be placed on the rim at the 12 o'clock position. If the wheel is still out of balance, move the weight to the 3 o'clock position. If the wheel is still out of balance, move the weight to the 6 o'clock position. If the wheel is still out of balance, move the weight to the 9 o'clock position. If the wheel is still out of balance, move the weight to the 12 o'clock position.

Use a rubber weight on the hub of a tube-type wheel. The weight should be placed on the hub at the 12 o'clock position. If the wheel is still out of balance, move the weight to the 3 o'clock position. If the wheel is still out of balance, move the weight to the 6 o'clock position. If the wheel is still out of balance, move the weight to the 9 o'clock position. If the wheel is still out of balance, move the weight to the 12 o'clock position.

**Balance Weight Installation**

For a wire spoke wheel, use a balance weight on the rim. For a tube-type wheel, use a balance weight on the hub.

**A. Balance weight on the rim.**

**B. Balance weight on the hub.**

**For a wire spoke wheel, use a balance weight on the rim.**

**For a tube-type wheel, use a balance weight on the hub.**

**NOTE:** Balance weights are available in 10, 20, and 30 gram sizes. An imbalance of more than 20 grams will affect the stability of the wheel.

**Proper Tire Pressure**

Proper tire pressure is essential for proper tire performance. Check the tire pressure regularly and adjust it as needed. The recommended tire pressure is listed in the owner's manual.

**NOTE:** Do not over-inflate the tires. Over-inflation can result in a harsh ride and uneven tire wear.



## WHEELS

Tubeless tires and cast wheels are installed on the wheels of the KZ/Z1000-J and K. Tube-type tires and wire-spoke wheels are installed on the wheels of the KZ1000-M.

### WARNING

1. The tires, rims, and air valves on the KZ/Z1000-J and K are designed only for tubeless type wheels. The recommended standard tires, rims, and air valves must be used for replacement. For correct performance, do not install a tube in a tubeless tire.

Structure of the tubeless tire is characterized by an inner liner and chafers.

The inner liner is a layer of thicker rubber which covers the inside wall of the tire. The inner liner is made from special quality of rubber which is hard to admit the air. Generally chafers reinforce tire beads which are likely damaged by friction with the rim. The chafers of tubeless tires have a characteristic of airtightness as well.

Since airtightness of tubeless tires is accomplished by closely seating the chafers in good condition on the rim, be careful not to damage the chafers when handling tubeless tires.

### Construction of Tires

Tubeless Tire (KZ/Z1000-J and K)

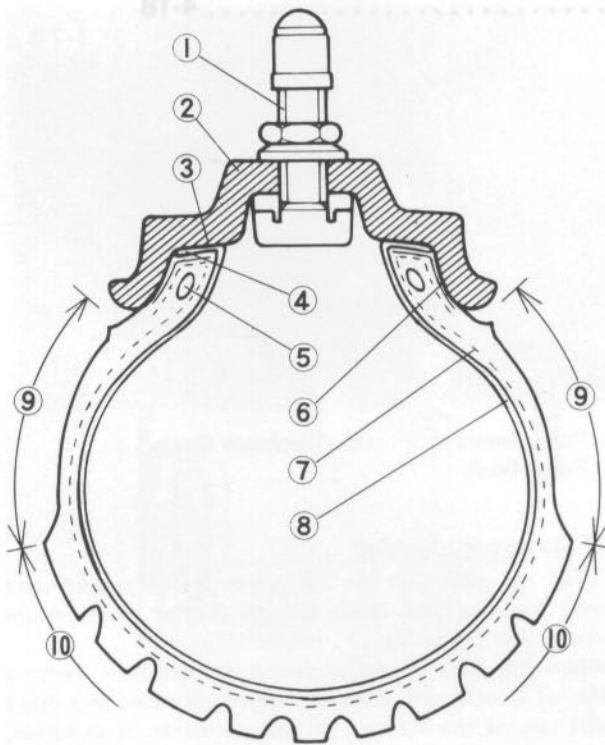

- |                      |                |
|----------------------|----------------|
| 1. Air Valve         | 6. Chafers     |
| 2. Rim               | 7. Plies       |
| 3. Rim Sealing Area  | 8. Inner Liner |
| 4. Bead Sealing Area | 9. Side Wall   |
| 5. Bead Wires        | 10. Tread      |

### Wheel Balance

To improve stability and decrease vibration at high speed, the front and rear wheels must be kept balanced.

Check and balance the wheels when required, or when a tire is replaced with a new one.

### To check the wheel balance:

- Remove the wheel.
- For a wire spoke wheel, check that all the spokes are tightened evenly and the rim runout is within the service limit (Pg. 2-23).
- Suspend the wheel so that it can be spun freely.
- Spin the wheel lightly, and mark the tire at the top when the wheel stops.
- Repeat this procedure several times.
- ★ If the wheel stops of its own accord in various positions, it is well balanced.
- ★ However, if the wheel always stops in one position, balance the wheel as follows.

4-1

Tube-Type Tire (KZ1000-M)

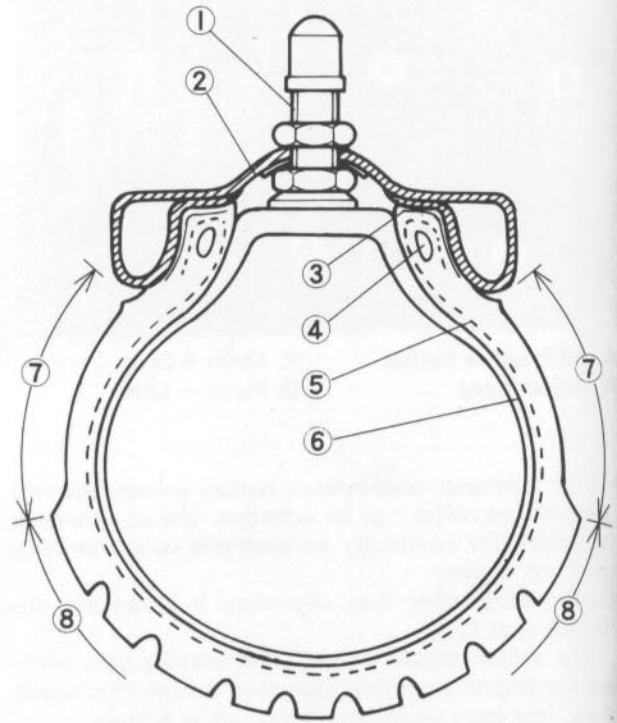

- |               |              |
|---------------|--------------|
| 1. Air Valve  | 5. Plies     |
| 2. Rim        | 6. Tube      |
| 3. Chafers    | 7. Side Wall |
| 4. Bead Wires | 8. Tread     |

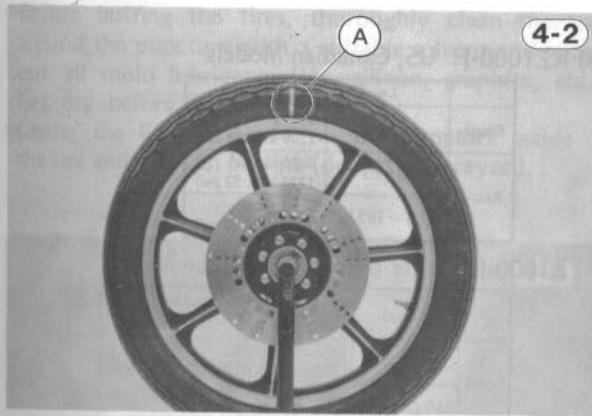

A. Mark at the top.

**To adjust wheel balance:**

- Temporarily attach a balance weight on the rim surface with tape.
- Rotate the wheel  $\frac{1}{4}$  turn, and see whether or not the wheel stays in this position. If it does, the correct balance weight is being used.

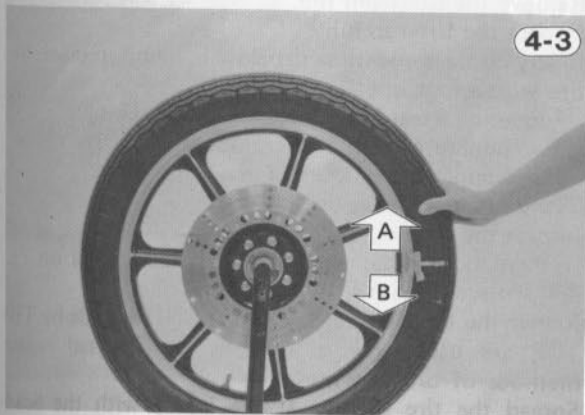

A. Use heavier weight.

B. Use lighter weight.

\*If the weighted location still stops at the top, try a heavier weight. If the weighted position always stops at the bottom, use slightly less weight. Repeat these steps until the wheel remains at rest after being rotated  $\frac{1}{4}$  turn.

- Rotate the wheel another  $\frac{1}{4}$  turn and then another  $\frac{1}{4}$  turn to see if the wheel is correctly balanced.
- Repeat the entire procedure as many times as necessary to achieve correct wheel balance.
- Install the balance weight firmly on the wheel.

For the cast wheel: First reduce the tire pressure, pry the tire bead from the rim, and then insert the blade part of the balance weight between the rim and the tire bead until the stepped portions of the rim and the weight is hooked over the overhang portion of the rim.

**Balance Weight Installation**

4-4

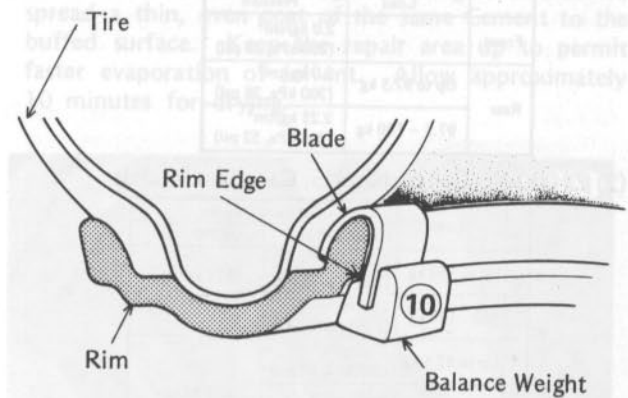

**NOTE:** 1. For cast wheels: Use balance weights of a new type. A new type weight is distinguished by a circle around the figures.

For the wire spoke wheel: Clamp on the balance weight firmly using pliers.

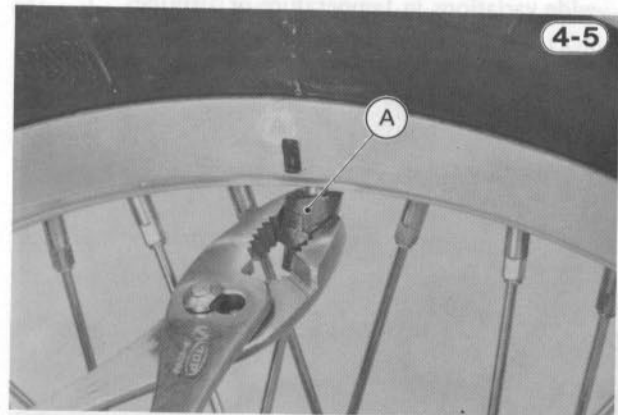

A. Balance Weight

- For the cast wheel, inflate the tire to standard pressure (Pg. 4-4).
- Reinstall the wheel back on the motorcycle.

**NOTE:** 1. Balance weights are available from Kawasaki dealers in 10, 20, and 30 gram sizes. An imbalance of less than 10 grams will not usually affect running stability.

**Tires:****Payload and Tire Pressure**

Failure to maintain proper inflation pressures or observe payload limits for your tires may adversely affect handling and performance of your motorcycle and can result in loss of control. The maximum recommended loads (including rider, passenger, baggage, and accessories) for each model in addition to vehicle weight are indicated in Table 4-1.

- Check the tire pressure often, using an accurate gauge.
- NOTE:** 1. Measure the tire pressure when the tires are cold (that is, when the motorcycle has not been ridden more than a mile during the past 3 hours).

**Table 4-1 Tire Air Pressure**

(1) KZ1000-K, M: US, Canadian Models

	Load	Pressure
Front	—	2.0 kg/cm <sup>2</sup> (200 kPa, 28 psi)
Rear	Up to 97.5 kg	2.0 kg/cm <sup>2</sup> (200 kPa, 28 psi)
	97.5 – 180 kg	2.25 kg/cm <sup>2</sup> (225 kPa, 32 psi)

(2) Z1000-K: Other than US, Canadian Models

	Load	Tire Air Pressure	
		Under 210 kph	Over 210 kph
Front	Up to 150 kg	2.0 kg/cm <sup>2</sup> (200 kPa, 28 psi)	2.25 kg/cm <sup>2</sup> (225 kPa, 32 psi)
	150 – 180 kg	2.25 kg/cm <sup>2</sup> (225 kPa, 32 psi)	
Rear	Up to 97.5 kg	2.0 kg/cm <sup>2</sup> (200 kPa, 28 psi)	2.90 kg/cm <sup>2</sup> (290 kPa, 41 psi)
	97.5 – 150 kg	2.25 kg/cm <sup>2</sup> (225 kPa, 32 psi)	
	150 – 180 kg	2.5 kg/cm <sup>2</sup> (250 kPa, 36 psi)	

2. Tire pressure is affected by changes in ambient temperature and altitude, and so the tire pressure should be checked and adjusted when your riding involves wide variations in temperature or altitude.

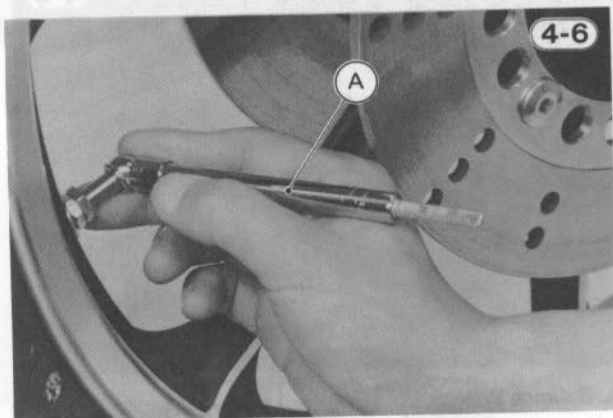
**A. Pressure Gauge**

### Tubeless Tire Repair

Currently two types of repair for tubeless tires have come into wide use. One type is called temporary (external) repairs which can be carried out without removing the tire from the rim, and another type is called permanent (internal) repairs which require tire removal. It is generally understood that higher running durability is obtained by permanent (internal) repairs than by temporary (external) ones. Also, permanent (internal) repairs also have the advantage of permitting a thorough examination for secondary damage not visible from external inspection of the tire. For these reasons, Kawasaki does not recommend temporary (external) repair. Only appropriate permanent (internal) repairs are recommended.

The tubeless tire repair methods described here describe the methods for COMBI UNITS made by TIP TOP (trade names). Repair methods may vary slightly from make to make. Follow the repair methods indicated by the manufacturer of the repair tools and materials so that safe results can be obtained.

(3) KZ1000-J: US, Canadian Models

	Load	Pressure
Front	—	2.0 kg/cm <sup>2</sup> (200 kPa, 28 psi)
Rear	Up to 97.5 kg	2.25 kg/cm <sup>2</sup> (225 kPa, 32 psi)
	97.5 – 165 kg	2.5 kg/cm <sup>2</sup> (250 kPa, 36 psi)

(4) Z1000-J: Other than US, Canadian Models

	Load	Tire Air Pressure	
		Under 210 kph	Over 210 kph
Front	Up to 150 kg	2.00 kg/cm <sup>2</sup> (200 kPa, 28 psi)	2.25 kg/cm <sup>2</sup> (225 kPa, 32 psi)
	150 – 180 kg	2.25 kg/cm <sup>2</sup> (225 kPa, 32 psi)	
Rear	Up to 150 kg	2.25 kg/cm <sup>2</sup> (225 kPa, 32 psi)	2.90 kg/cm <sup>2</sup> (290 kPa, 41 psi)
	150 – 180 kg	2.50 kg/cm <sup>2</sup> (250 kPa, 36 psi)	

### WARNING

1. Tires that have been punctured and repaired do not have the same capabilities as unchanged tires. When being repaired with COMBI UNITS made by TIP TOP, do not exceed 80 kph within 24 hours after repair, and 180 kph at any time after that.

- Locate and mark the puncture and remove the injuring object.
  - Remove the tire from rim.
  - Inspect the tire carefully.
  - ★ If any damage mentioned below is found, replace the tire with a new one:
    1. Puncture or tear larger than 3 mm diameter.
    2. Two punctures within 40 cm distance.
    3. Three punctures or more in one tire.
    4. Puncture or damage on sidewall.
  - Inspect the rim.
  - ★ If there is any damage such as is mentioned on Pg. 4-7, replace the rim with a new one.
  - Repair the tire puncture. COMBI UNITS made by TIP TOP are used here to describe the internal repair methods of tubeless tires.
    - Spread the tire slightly at the injury with the bead breaker (special tool). Choose a drill bit of slightly greater diameter than the injury.
- NOTE:** 1. The diameter of a drill must be less than 3 mm at maximum.

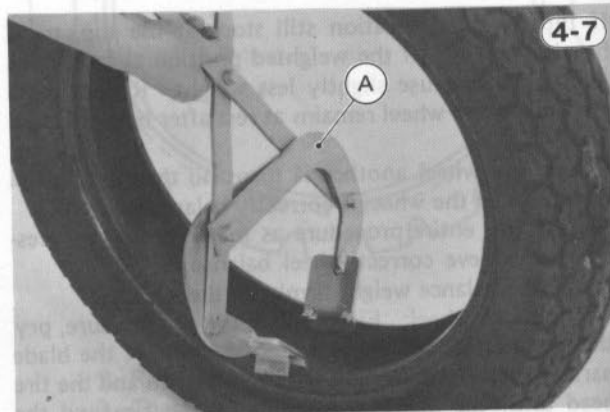
**A. Bead Breaker: 57001-1072**

- Before buffing the tires, thoroughly clean the area around the puncture with a suitable solvent and scrape out all mold lubricants (i.e., silicon, graphite, etc.). Let dry before buffing.
- Center the COMBI UNIT on the puncture inside of the tire and draw an outline (do not use crayon).



- Buff the area slightly larger than the COMBI UNIT, remove the buffing dust.

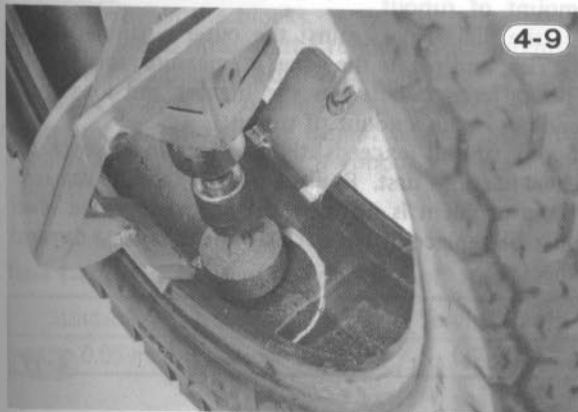

- Center the drill in the break inside of the tire and screw into the puncture.

**NOTE:** 1. Be careful not to expand the injury with the drill.



- Clean the buffed area thoroughly.
- Coat the puncture channel with a heavy layer of Rema Special Tire Cement. Using clean fingers or a brush, spread a thin, even coat of the same Cement to the buffed surface. Keep the repair area up to permit faster evaporation of solvent. Allow approximately 10 minutes for drying.



- Use the COMBI UNIT for motorcycle tires. Remove the protective sleeve from the stem of the COMBI UNIT. Break the metal foil across the center and peel the foil toward the edge. Coat the surface with a thin layer of Special Tire Cement. Do not touch the patch area.

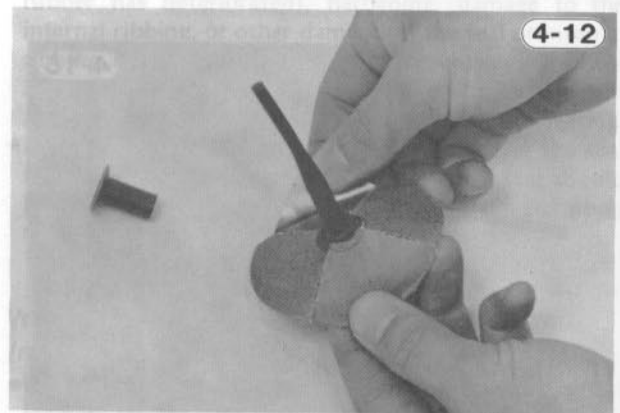

- Run the stem of the COMBI UNIT patch through the inserting wire.

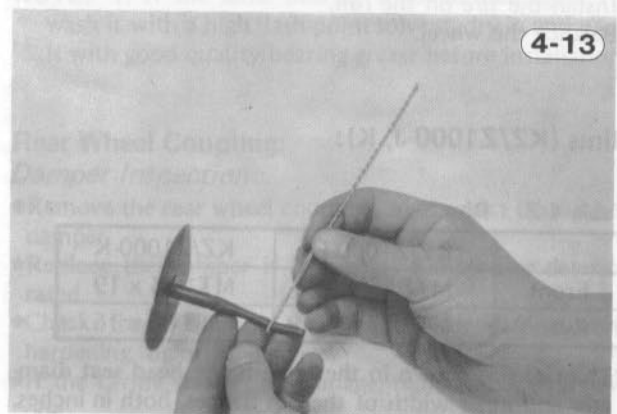

- Apply Special Tire Cement to the upper end of the stem (30 mm above the patch) so that the stem of COMBI UNIT patch slips smoothly.
- Pull the end of the stem through the puncture without turning until the base presses against inside of the tire.

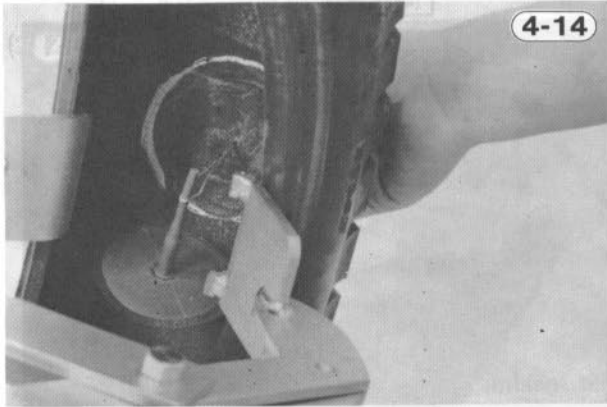

- Roll the stitcher over the patch as hard as possible, keeping strokes close together and working from the center outwards.
- Cut off the protruding rubber tail flush with the tire surface.



- Install the tire on the rim.
- Balance the wheel.

**Rims (KZ/Z1000-J, K):**

**Table 4-2 Rim Size**

	KZ/Z1000-J	KZ/Z1000-K
Front	MT1.85 x 19	MT1.85 x 19
Rear	MT2.15 x 18	MT3.00 x 16

\*The rim size shown in the table is the bead seat diameter and inner width of the rim flanges, both in inches.

**Rim Sizes**

**4-16**

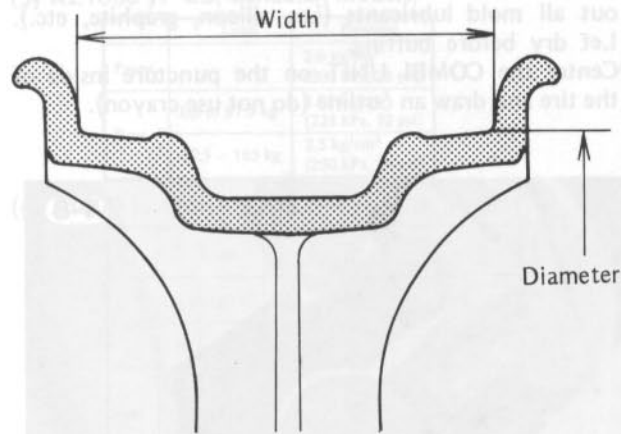

**Rim Runout**

If there is any doubt as to the condition of the wheel, or if the wheel has received a heavy impact, check the rim runout as follows:

- Remove the tire and suspend the wheel by the axle.
- Set a dial gauge against the side of the rim, and rotate the wheel to measure the axial runout. The difference between the highest and lowest dial readings is the amount of runout.
- Set the dial gauge against the outer circumference of the rim, and rotate the wheel to measure radial runout. The difference between the highest and lowest dial readings is the amount of runout.
- ★If rim runout exceeds the service limit, check the wheel bearings first. Replace them if they are damaged. If the problem is not due to the bearings, the wheel must be replaced. Do not attempt to repair a damaged wheel.

**Rim Runout**

**4-17**

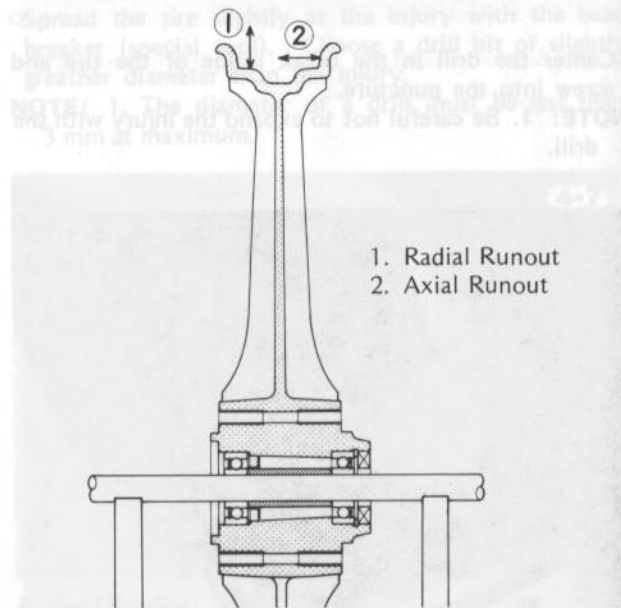

Table 4-3 Rim Runout

	Axial	Radial
Service Limit	0.5 mm	0.8 mm

### Rim Damage

- Carefully inspect the wheel for small cracks, dents, bends, or warp.
- ★If there is any damage to the wheel, it must be replaced.

#### WARNING

1. Never attempt to repair a damaged wheel. If there is any damage besides wheel bearings, the wheel must be replaced to insure safe operational condition.

- ★If the rim has a scratch deeper than 0.5 mm and/or across the rim sealing surface, replace the wheel.

### Axles:

A bent axle causes vibration, poor handling, and instability.

### Axle Runout

- Remove the axle, place it in V blocks that are 100 mm apart, and set a dial gauge to the axle at a point halfway between the blocks.
- Turn the axle to measure the runout. The amount of runout is the amount of dial variation.
- ★If runout exceeds the usable range, straighten the axle or replace it. If the axle cannot be straightened to within the usable range, or if runout exceeds service limit, replace the axle.

Table 4-4 Axle Runout/100 mm (Front, Rear)

Standard	Usable Range	Service Limit
under 0.05 mm	under 0.2 mm	0.7 mm

### Axle Runout

4-18

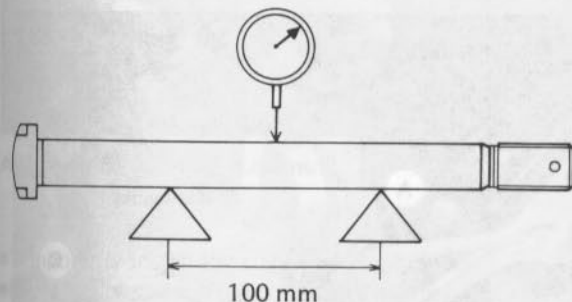

### Grease Seals:

A grease seal is fitted in the speed sensor, in the right side of the front and rear hubs, and in the rear wheel coupling. Each grease seal is a rubber ring equipped with a steel band on its outer circumference. The grease seal inner lip is held against the axle collar by a wire

spring band. Since the grease seal not only seals in the wheel bearing grease but also keeps dirt and moisture from entering the hub, the use of a damaged grease seal will cause the wheel bearing to wear quickly.

### Grease Seal

4-19

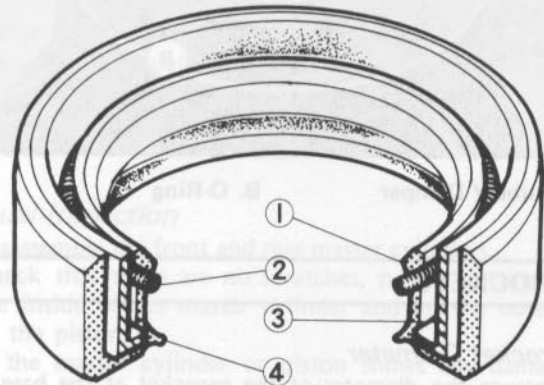

1. Secondary Lip
2. Spring Band
3. Steel Band
4. Primary Lip

### Inspection

- If the grease seals are examined without removing the seals themselves, look for discoloration (indicating the rubber has deteriorated), hardening, damage to the internal ribbing, or other damage. If the seal or internal ribbing has hardened, the clearance between the seal and the axle sleeve will not be taken up, which will allow dirt and moisture to enter and reach the bearing.
- ★If in doubt as to its condition and whenever the seal is removed for greasing the bearing, the seal should be replaced. The seals are generally damaged upon removal.

### Wheel Bearings:

#### Inspection

- Wash the bearing with a high flash-point solvent, dry it (Do not spin it while it is dry), and oil it.
- Spin it by hand to check its condition.
- ★If it is noisy, does not spin smoothly, or has any rough spots, it must be replaced.

**NOTE:** 1. If the same bearing is to be used again, rewash it with a high flash-point solvent, dry it, and pack it with good quality bearing grease before installation.

### Rear Wheel Coupling:

#### Damper Inspection

- Remove the rear wheel coupling, and inspect the rubber damper.
- ★Replace the damper if it appears damaged or deteriorated.
- Check the O-ring on the coupling for deformation, hardening, or other damage.
- ★If the O-ring shows any damage, replace it with a new one.

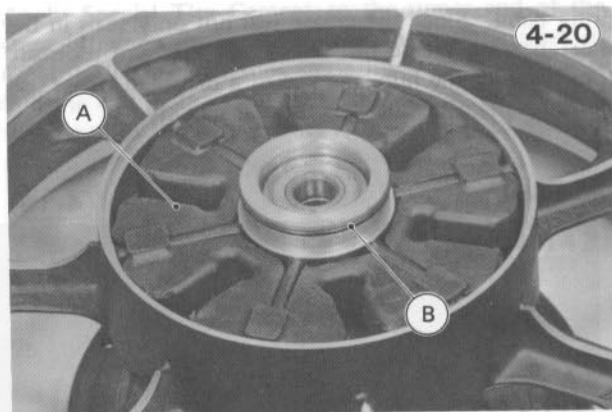

A. Rubber Damper B. O-Ring

**SPROCKETS**

*Sprocket Diameter*

- Measure the diameter of the sprocket at the base of the teeth.
- ★ If the sprocket is worn down to less than the service limit, replace the sprocket.

**NOTE:** 1. If the brake pedal position cannot be adjusted by turning the push rod, the brake pedal may be deformed or incorrectly installed (Pg. 7-20).

**Table 4-5 Engine Sprocket Diameter**

Standard	Service Limit
79.01 – 79.21 mm	78.3 mm

**Table 4-6 Rear Sprocket Diameter**

Tooth No.	Standard	Service Limit
39	224.59 – 225.09 mm	224.3 mm
41	236.72 – 237.22 mm	236.4 mm

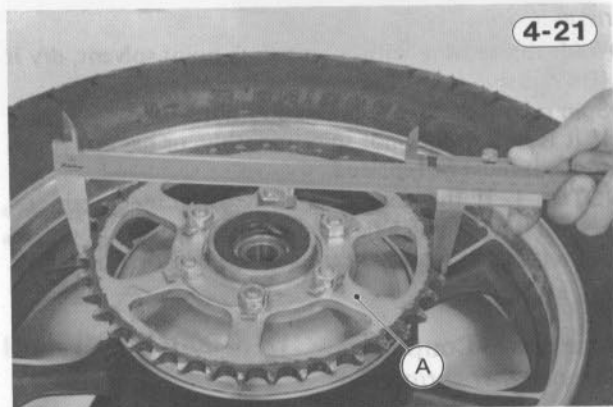

A. Rear Sprocket

*Rear Sprocket Warp*

- Elevate the rear wheel so that it will turn freely, and set a dial gauge against the rear sprocket near the teeth as shown in the figure.

- Rotate the rear wheel, and read the dial gauge. The difference between the highest and lowest dial gauge readings is the amount of runout (warp).
- ★ If the runout exceeds the service limit, replace the rear sprocket.

**Table 4-7 Rear Sprocket Warp**

Standard	Service Limit
under 0.4 mm	0.5 mm

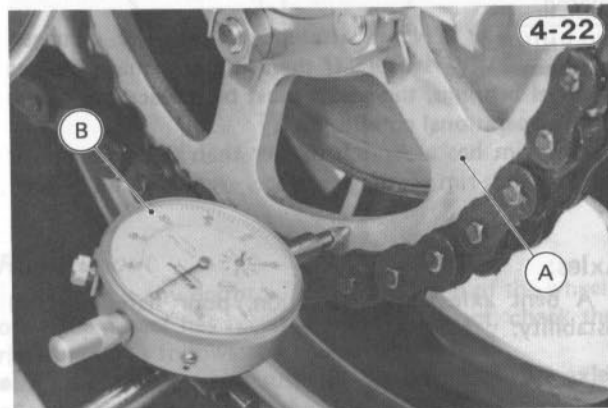

A. Rear Sprocket B. Dial Gauge

**BRAKES**

**Brake Pedal Position:**

*Pedal Position Inspection*

- When the brake pedal is in its rest position, it should be slightly lower than the top of the footpeg. See Table 4-8.

**Table 4-8 Brake Pedal Position**

Models	Pedal Position
KZ1000-J, M: US, Canadian Models KZ/Z1000-K: All Models	8 – 12 mm below from top of footpeg
Z1000-J: Other than US, Canadian Models	13 – 17 mm below from top of footpeg

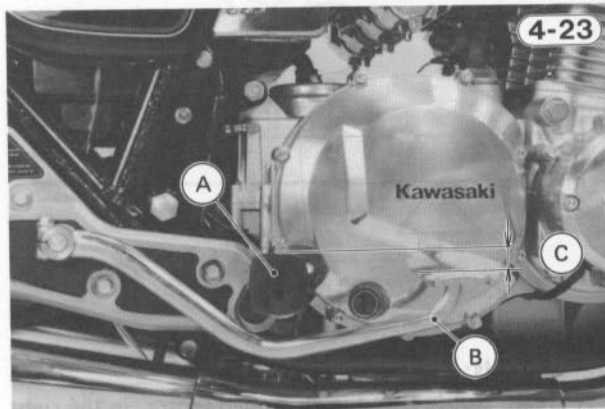

A. Footpeg B. Brake Pedal C. Brake Pedal Position

- ★ If it is not within the specified range, adjust the brake pedal position as follows.

### Pedal Position Adjustment

- Remove the muffler mounting bolt, remove the footpeg bracket mounting bolts (3), and free the rear brake light switch spring from the switch. Remove the brake pedal if necessary.

**WARNING** 1. Take care not to damage the brake hose. Damage to the brake line greatly reduces the brake line strength and causes brake fluid leakage, resulting in the loss of brake control.

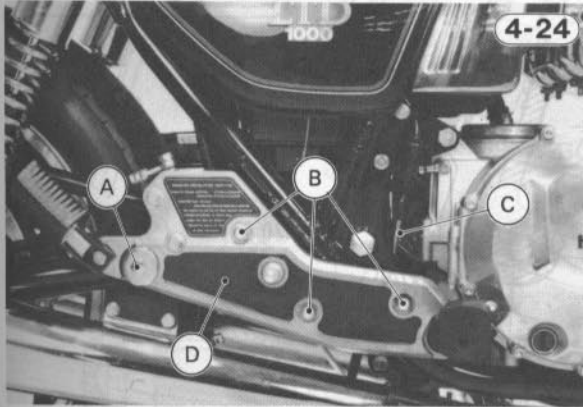

A. Muffler Mounting Bolt  
B. Bracket Mounting Bolts  
C. Brake Light Switch Spring  
D. Bracket

- Loosen the locknut and turn the push rod to adjust the brake pedal position. Tighten the locknut.

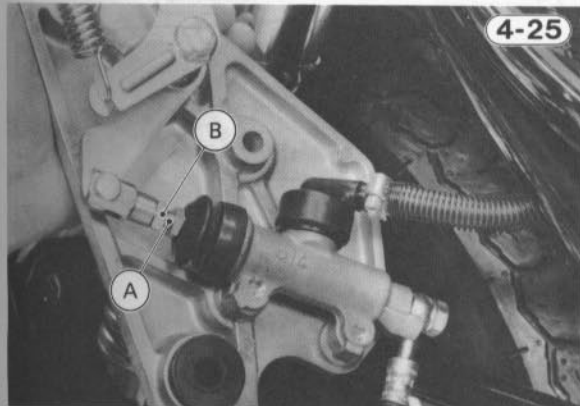

A. Push Rod  
B. Locknut

- Temporarily install the right footpeg bracket.
- If the brake pedal has been removed, install the brake pedal on the pivot shaft so that the line mark on the pedal is aligned with the punch mark on the shaft, and check the brake pedal position.
- If the pedal position is not correct, remove the brake pedal and bracket, and readjust the position.

**NOTE:** 1. If the brake pedal position cannot be adjusted by turning the push rod, the brake pedal may be deformed or incorrectly installed (Pg. 7-20).

- Remove the brake pedal, install the brake light switch spring, and install the bracket, tightening bracket mounting bolts (3).
- Install and tighten the muffler mounting bolt.
- Install the brake pedal, and tighten the bolt.
- Check the operation of the rear brake and the brake light switch (Pg. 2-18).

### Master Cylinders:

When master cylinder parts are worn or damaged, proper brake fluid pressure cannot be obtained in the line, and the brake will not hold.

### Visual Inspection

- Disassemble the front and rear master cylinders.
- Check that there are no scratches, rust or pitting on the inside of the master cylinder and on the outside of the piston.
- If the master cylinder or piston shows any damage, replace the master cylinder and piston.
- Inspect the primary and secondary cups.
- If a cup is worn, damaged, softened (rotted), or swollen, replace the piston assembly.
- If fluid leakage is noted at the brake lever, the piston assembly should be replaced to renew the cups.

**NOTE:** 1. The cups and spring are part of the piston assembly. Replace the piston assembly if any one of the cups or the spring requires replacement.

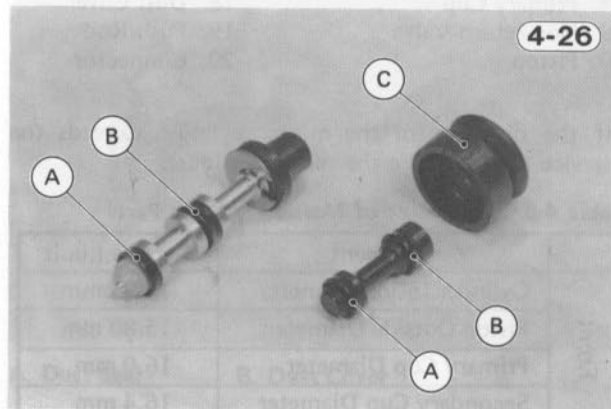

A. Primary Cup  
B. Secondary Cup  
C. Dust Cover

- Check the dust covers for damage.
- If they are damaged, replace them.
- Check that the relief and supply ports are not plugged.
- If the small relief port becomes plugged, especially with a swollen or damaged primary cup, the brake pads will drag on the disc. Blow the ports clean with compressed air.
- Measure the cylinder inside diameter, and measure the outside diameter of the piston, primary cup, and secondary cup.
- If any diameter of the piston and cups is less than the service limit, replace the piston assembly.



Front and Rear Master Cylinders

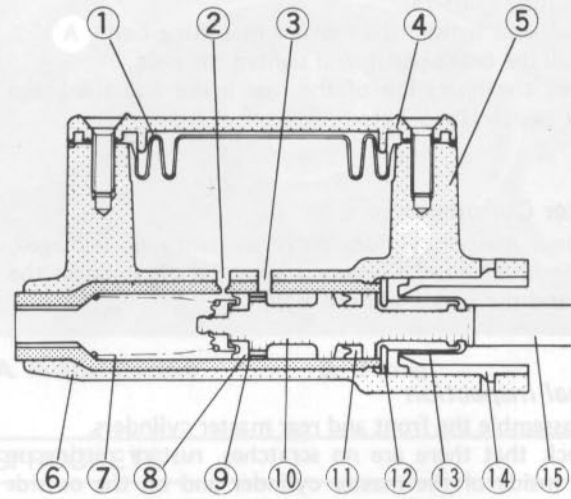

- 1. Diaphragm
- 2. Relief Port
- 3. Supply Port
- 4. Cap
- 5. Reservoir
- 6. Master Cylinder Body
- 7. Spring
- 8. Primary Cup
- 9. Non-return Valve
- 10. Piston
- 11. Secondary Cup
- 12. Piston Stop
- 13. Dust Seal
- 14. Liner
- 15. Brake Lever

★If the diameter of the master cylinder exceeds the service limit, replace the master cylinder.

Table 4-9 Diameter of Master Cylinder Parts

	Measurement	Service Limit
Front	Cylinder Inside Diameter	15.95 mm
	Piston Outside Diameter	15.80 mm
	Primary Cup Diameter	16.0 mm
	Secondary Cup Diameter	16.4 mm
Rear	Cylinder Inside Diameter	14.08 mm
	Piston Outside Diameter	13.80 mm
	Primary Cup Diameter	14.1 mm
	Secondary Cup Diameter	14.6 mm

- Check that the spring is not damaged and the spring free length is not shorter than the service limit.
- ★If the free length is shorter than the service limit, replace the piston assembly.

Table 4-10 Spring Free Length

	Standard	Service Limit
Front	36.6 – 40.6 mm	34.8 mm
Rear	34.5 – 38.5 mm	32.8 mm

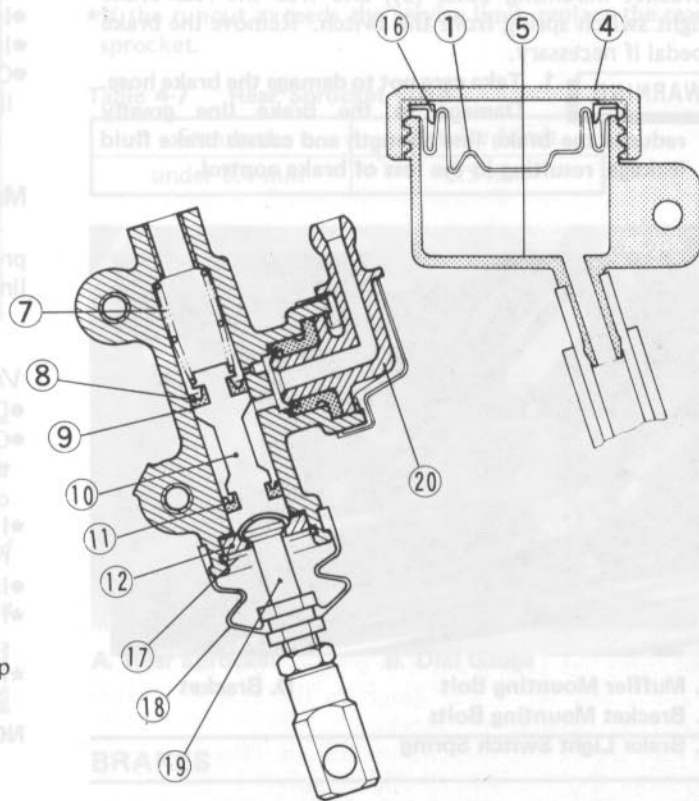

Brake Pedal Position

When the brake pedal is in its rest position, the top of the footpeg should be slightly lower than the top of the toepeg. See Table 4-5.

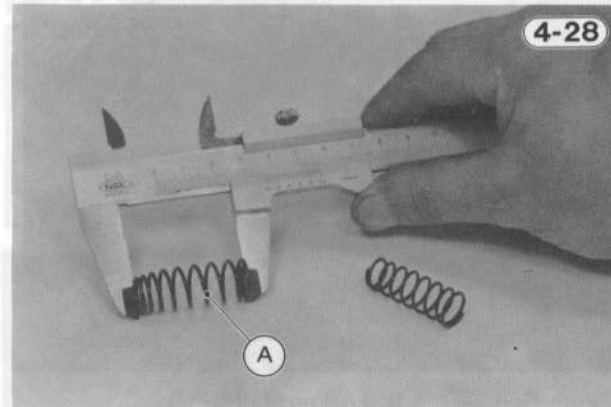

A. Spring

Calipers:  
Pad Wear

- Measure the thickness of the pad linings.
- ★Replace both pads as a set if the lining thickness of either pad is less than 1 mm.

Brake Pad

4-29

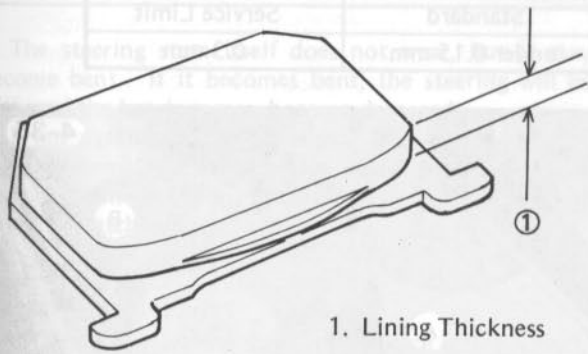

Front Caliper

4-30

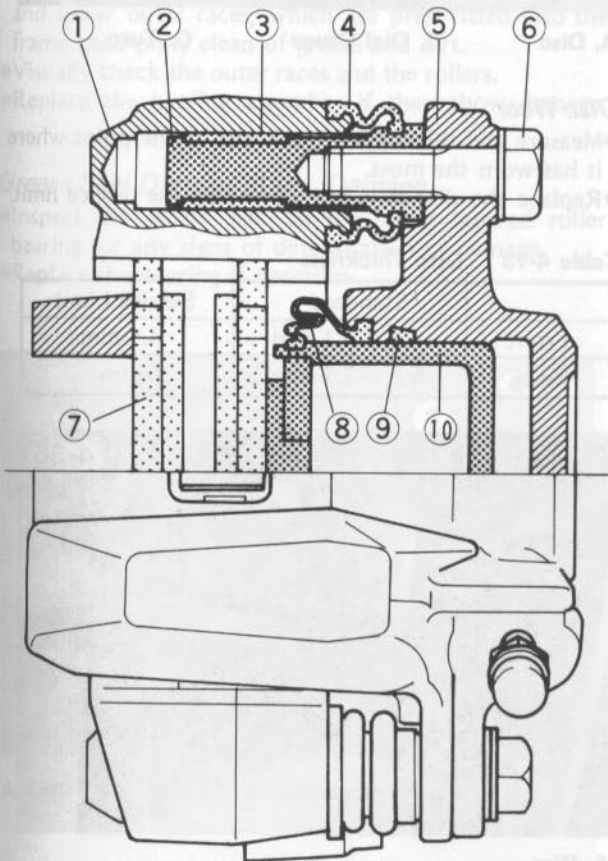

- 1. Caliper Holder
- 2. Holder Shaft
- 3. Friction Boot
- 4. Dust Cover
- 5. Caliper
- 6. Holder Shaft Bolt
- 7. Pad
- 8. Dust Seal
- 9. Fluid Seal
- 10. Piston

**Fluid Seal Damage**

The fluid seal around the piston maintains the proper pad/disc clearance. If this seal is not satisfactory, pad wear will increase, and constant pad drag on the disc will raise brake and brake fluid temperature.

Replace the fluid seals under any of the following conditions: (a) fluid leakage around the pad; (b) brakes overheat; (c) there is a large difference in left and right pad wear; (d) the seal is stuck to the piston. If the fluid seal is replaced, replace the dust seal as well. Also, replace all seals every other time the pads are changed.

4-31

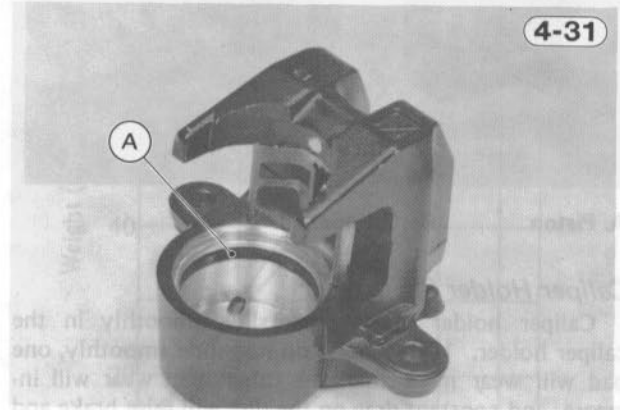

A. Fluid Seal

**Dust Seal and Cover Damage**

- Check that the dust seals and covers are not cracked, worn, swollen, or otherwise damaged.
- ★ If they show any damage, replace them.

4-32

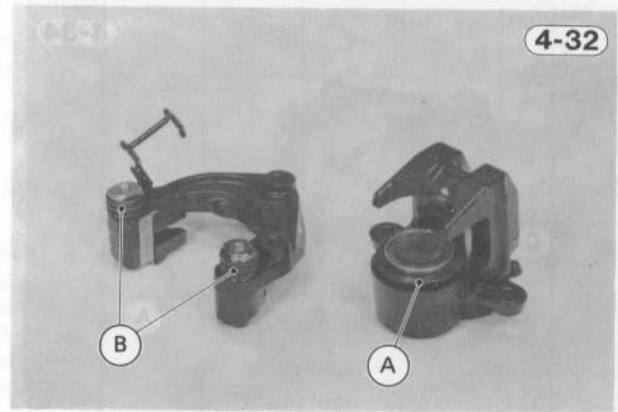

A. Dust Seal      B. Dust Cover

**Piston, Cylinder Wear**

- Measure the cylinder inside diameter and piston outside diameter, and visually inspect the piston and cylinder surfaces.
- ★ Replace the cylinder and piston if they are worn out of tolerance, badly scored, or rusty.

Table 4-11 Caliper Parts (Front, Rear)

	Standard	Service Limit
Cylinder Inside Diameter	42.85 – 42.90 mm	42.92 mm
Piston Outside Diameter	42.77 – 42.82 mm	42.75 mm

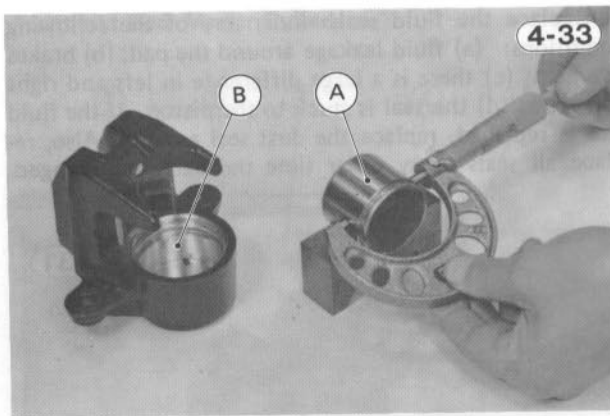

A. Piston B. Cylinder

### Caliper Holder Shaft Wear

Caliper holder shafts must slide smoothly in the caliper holder. If the shafts do not slide smoothly, one pad will wear more than the other, pad wear will increase, and constant drag on the disc will raise brake and brake fluid temperature.

- Check to see if the caliper holder shafts are not badly worn or stepped, or rubber friction boots are not damaged.
- ★ If the shafts or rubber friction boot are damaged, replace the shafts, rubber friction boot, and the caliper holder.

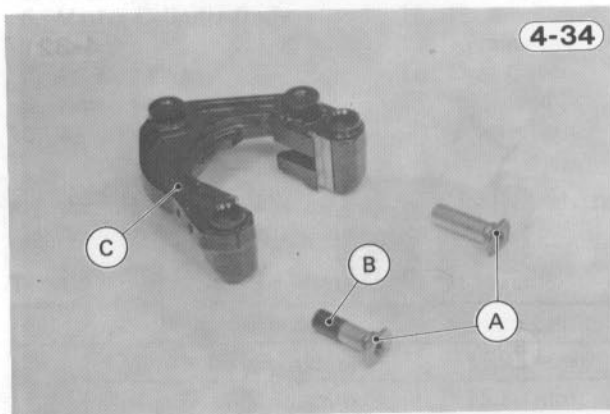

A. Caliper Holder Shaft B. Friction Boot C. Caliper Holder

### Brake Discs:

Besides wearing down, the disc may warp. A warped disc will cause the brake pads to drag on the disc and will wear down both the pads and disc quickly. Dragging will also cause overheating and poor braking efficiency.

### Disc Warp

- Jack up the motorcycle so that the front wheel is off the ground, and turn the handlebar fully to one side.
- Set up a dial gauge against the front disc as illustrated, and measure disc runout.
- Remove the jack, set the motorcycle up on its center stand, and then measure the rear disc runout.
- ★ If runout exceeds the service limit, replace the disc.

Table 4-12 Disc Runout (Front, Rear)

Standard	Service Limit
under 0.15 mm	0.3 mm

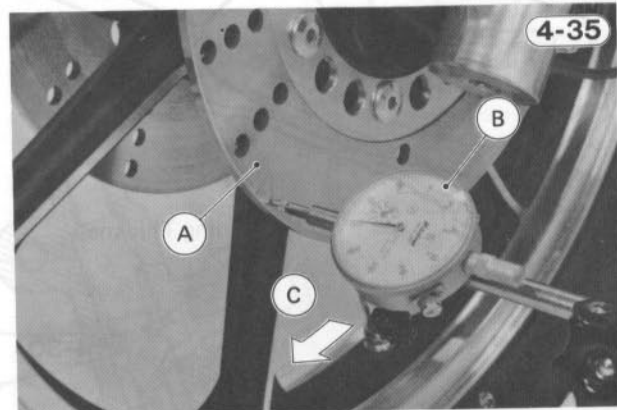

A. Disc B. Dial Gauge C. Turn.

### Disc Wear

- Measure the thickness of each disc at the point where it has worn the most.
- ★ Replace the disc if it has worn past the service limit.

Table 4-13 Disc Thickness

	Standard	Service Limit
Front	4.8 – 5.1 mm	4.5 mm
Rear	6.8 – 7.1 mm	6 mm

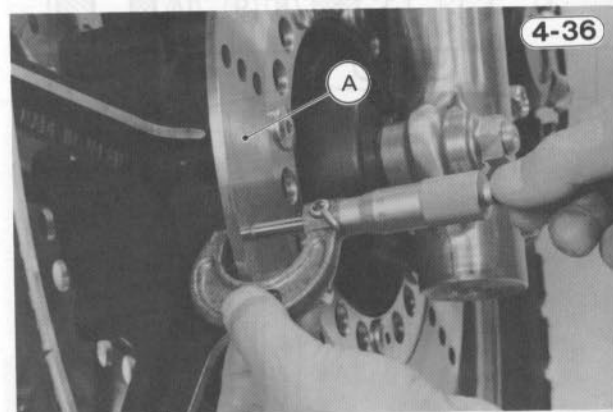

A. Disc

### Disc Cleaning

Poor braking can also be caused by oil on the disc. Oil on the disc must be cleaned off with trichloroethylene or a high flash-point solvent. Do not use one which will leave an oily residue.

### Brake Hoses:

#### Brake Line Damage

The high pressure inside the brake line can cause fluid to leak or the hose to burst if the line is not properly maintained.

- Bend and twist the rubber hose while examining it.
- ★ Replace it if any cracks or bulges are noticed.

## STEERING

The steering stem itself does not wear, but it may become bent. If it becomes bent, the steering will be stiff, and the bearings may become damaged.

From overtightening or from a heavy shock to the steering stem, the bearing race surfaces may become dented. Damaged bearing races will cause the handlebar to jerk or catch when turned.

### Steering Stem Warp

Examine the steering stem, and replace it if it is bent.

### Bearing Wear, Damage

- Using a high flash-point solvent, wash the upper and lower tapered rollers in the cages, and wipe the upper and lower outer races, which are press-fitted into the frame head pipe, clean of grease and dirt.
- Visually check the outer races and the rollers.
- ★ Replace the bearing assembly if they show damage.

### Grease Seal Deterioration, Damage

- Inspect the grease seal on the upper tapered roller bearing for any signs of deterioration or damage.
- ★ Replace the bearing if necessary.

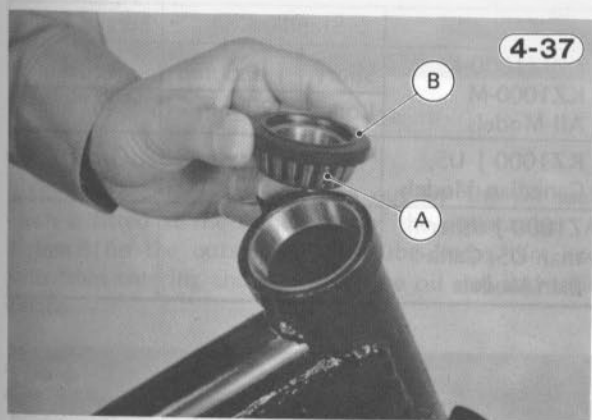

A. Steering bearing      B. Grease Seal

## FRONT FORK

The front fork legs of this model contain compressed air for optimum performance. This type of front fork is especially effective when the fork is almost fully compressed. It also has the advantage that the air pressure can be varied within the usable range to suit various riding conditions.

Front Fork Spring Force (per one fork leg unit) **4-38**  
(1)KZ/Z1000-J

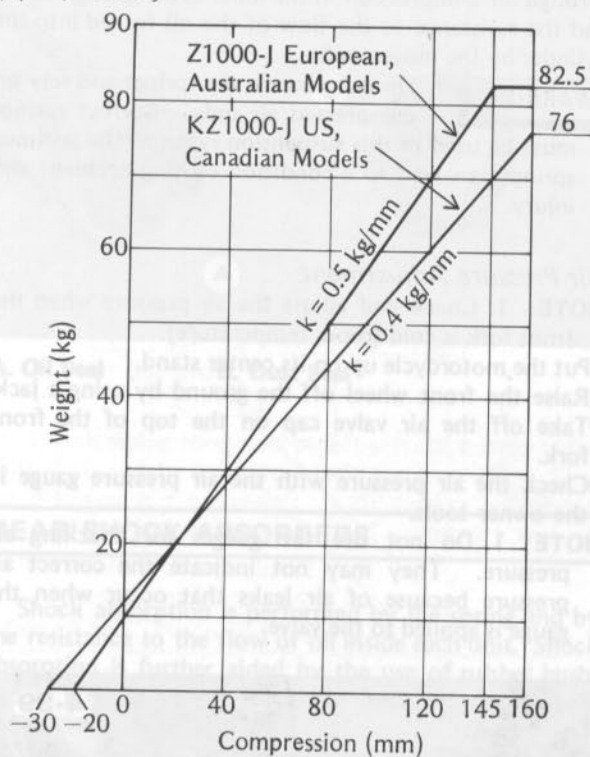

(2)KZ/Z1000-K, KZ1000-M

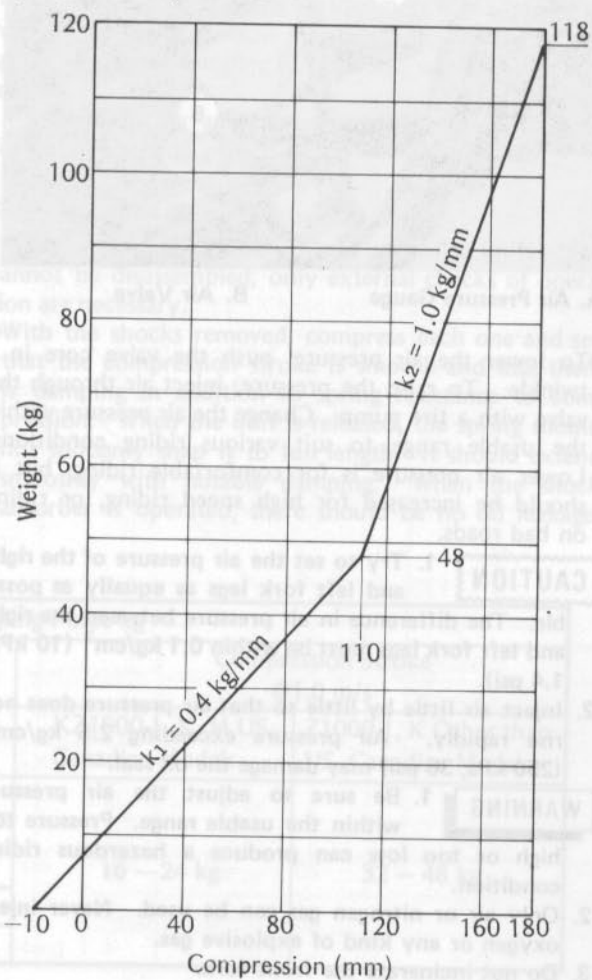

The front fork accomplishes shock absorption through air compression in the inner tube, spring action, and the resistance to the flow of the oil forced into the cylinder by the movement.

**WARNING** 1. Do not remove the springs and rely on compressed air only. Correct springs must be used in this suspension system. Use without springs can lead to a condition causing accident and injury.

### Air Pressure Adjustment

**NOTE:** 1. Check and adjust the air pressure when the front fork is cold (room temperature).

- Put the motorcycle up on its center stand.
- Raise the front wheel off the ground by using a jack.
- Take off the air valve cap on the top of the front fork.
- Check the air pressure with the air pressure gauge in the owner tools.

**NOTE:** 1. Do not use tire gauges for checking air pressure. They may not indicate the correct air pressure because of air leaks that occur when the gauge is applied to the valve.

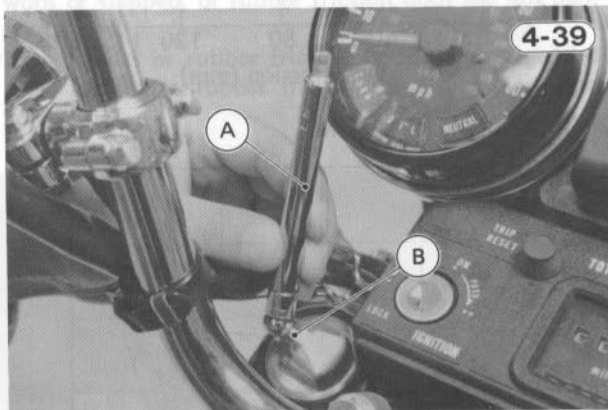

A. Air Pressure Gauge

B. Air Valve

- To lower the air pressure, push the valve core in a twinkle. To raise the pressure, inject air through the valve with a tire pump. Change the air pressure within the usable range to suit various riding conditions. Lower air pressure is for comfortable riding, but it should be increased for high speed riding, or riding on bad roads.

**CAUTION** 1. Try to set the air pressure of the right and left fork legs as equally as possible. The difference in air pressure between the right and left fork legs must be within 0.1 kg/cm<sup>2</sup> (10 kPa, 1.4 psi).

2. Inject air little by little so that air pressure does not rise rapidly. Air pressure exceeding 2.5 kg/cm<sup>2</sup> (250 kPa, 36 psi) may damage the oil seal.

**WARNING** 1. Be sure to adjust the air pressure within the usable range. Pressure too high or too low can produce a hazardous riding condition.

2. Only air or nitrogen gas can be used. Never inject oxygen or any kind of explosive gas.
3. Do not incinerate the front fork.

Table 4-14 Front Fork Air Pressure

Models	Standard	Usable Range
KZ1000-J US, Canadian Models	0.3 kg/cm <sup>2</sup> (30 kPa, 4.3 psi)	0.25 – 0.35 kg/cm <sup>2</sup> (25 – 35 kPa, 3.6 – 5.0 psi)
Z1000-J Other than US, Canadian Models	0.5 kg/cm <sup>2</sup> (50 kPa, 7.1 psi)	0.45 – 0.55 kg/cm <sup>2</sup> (45 – 55 kPa, 6.4 – 7.8 psi)
KZ/Z1000-K, KZ1000-M All Models	0.5 kg/cm <sup>2</sup> (50 kPa, 7.1 psi)	0.4 – 0.6 kg/cm <sup>2</sup> (40 – 60 kPa, 5.7 – 8.5 psi)

### Springs:

The front fork springs in the inner tube are made of special spring rods, heated and wound in the shape of a special coil, to suspend the vehicle.

### Spring Tension

- Since the spring becomes shorter as it weakens, check its free length to determine its condition.
- ★If the spring of either fork leg is shorter than the service limit, it must be replaced. If the length of a replacement spring and that of the remaining spring vary greatly, the remaining spring should also be replaced in order to keep the fork legs balanced for motorcycle stability.

Table 4-15 Fork Spring Free Length

	Standard		Service Limit
	Short	Long	
KZ/Z1000-K, KZ1000-M All Models	130.5 mm	470 mm	128 mm 461 mm
KZ1000-J US, Canadian Models	554 mm		543 mm
Z1000-J other than US, Cana- dian Models	529 mm		518 mm

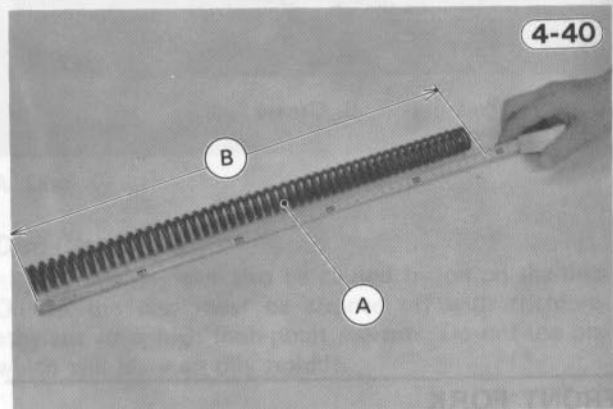

A. Fork Spring

B. Free Length

### Inner Tubes, Guide Bushes:

A bent, dented, scored, or otherwise damaged inner tube will damage the oil seal, causing oil leakage. A badly bent inner tube may cause poor handling.

**Inner Tube Damage**

- Visually inspect the inner tube, and repair any damage.
- ★If the damage is not repairable, replace the inner tube. Since damage to the inner tube damages the oil seal, replace the oil seal whenever the inner tube is repaired or replaced.
- Temporarily assemble the inner and outer tubes, and pump them back and forth manually to check for smooth operation.

**CAUTION**

1. If the inner tube is bent or badly creased, replace it. Excessive bending, followed by subsequent straightening, can weaken the inner tube.

**Guide Bush Damage**

- Visually inspect the guide bushes.
- ★Replace the inner tube assembly or outer tube assembly if it has badly damage.

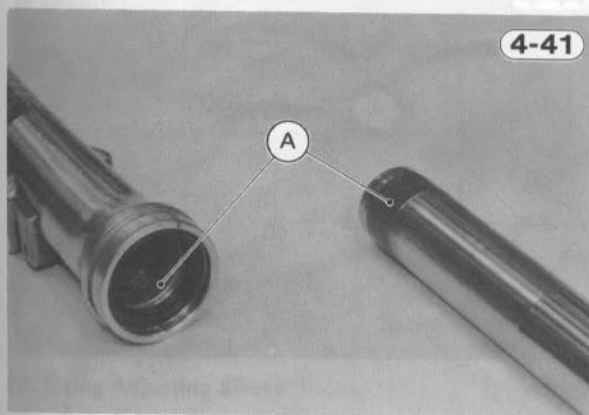

A. Guide Bushes

**Oil Seals, Dust Seals:**

Oil is prevented from leaking out by the oil seal, which is fitted at the upper end of the outer tube. A dust seal on the outside of the tube keeps dirt and water from entering and damaging the oil seal and tube surface.

**Inspection**

- Inspect the oil seal and dust seal for any signs of deterioration or damage.
- ★Replace them if necessary. Replace the oil seal with a new one whenever it has been removed.

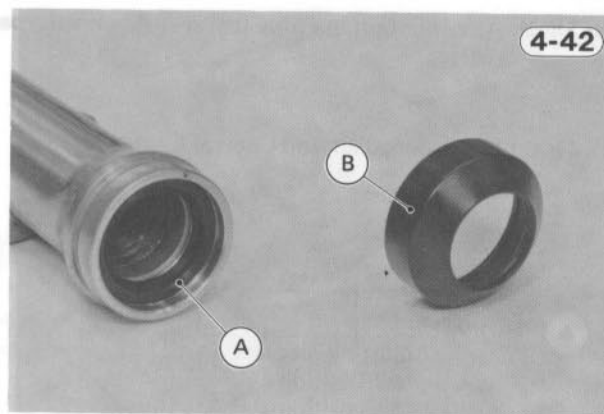

A. Oil Seal

B. Dust Seal

**REAR SHOCK ABSORBERS**

Shock absorption is performed by the spring and by the resistance to the flow of oil inside each unit. Shock absorption is further aided by the use of rubber bushings in both the upper and lower shock absorber mountings.

Shock absorber spring force for the 7 different settings is shown in graph of Fig. 4-43, and the damping force for 5 different settings is shown in Table 4-15. The rear shock absorbers can be adjusted by changing the spring force and damping force to suit various riding and loading conditions.

Before making any adjustments, however, read the following procedures:

**Rear Shock Absorber Inspection**

Since the rear shock absorbers are sealed units which cannot be disassembled, only external checks of operation are necessary.

- With the shocks removed, compress each one and see that the compression stroke is smooth and that there is damping in addition to spring resistance to compression. When the unit is released, the spring should not suddenly snap it to full length. It should extend smoothly with notable damping. When the shock absorber is operated, there should be no oil leakage.

Table 4-15 Shock Absorber Damping Force

Adjuster Position	Damping Force kg			
	Extension Stroke @0.3 m/s		Compression Stroke @1.0 m/s	
	KZ/Z1000-J All Models	KZ/Z1000-K, KZ1000-M All Models	KZ1000-J, K, M US, Canadian Models	Z1000-J, K Other than US, Canadian Models
1	36.0 – 54.0	27.2 – 40.8	16 – 24 kg	32 – 48 kg
2	44.0 – 66.0	33.6 – 50.4		
3	52.0 – 78.0	40.0 – 60.0		
4	57.6 – 86.4	44.0 – 66.0		
5	64.0 – 96.0	49.6 – 74.4		

(1)KZ1000-J (US, Canadian, and General Export Models)

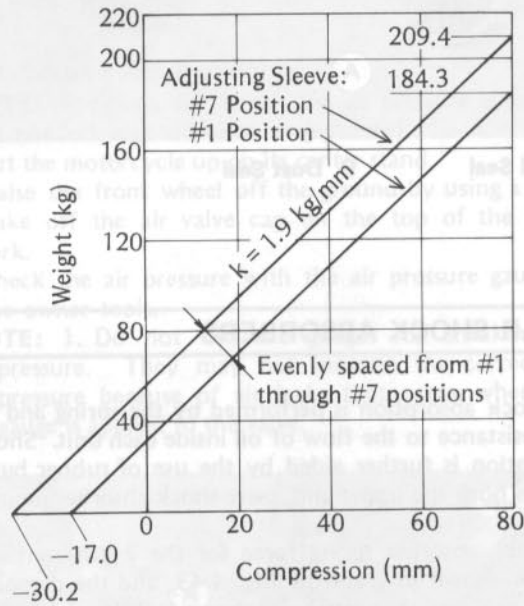

(3)KZ1000-K, M (US and Canadian Models)

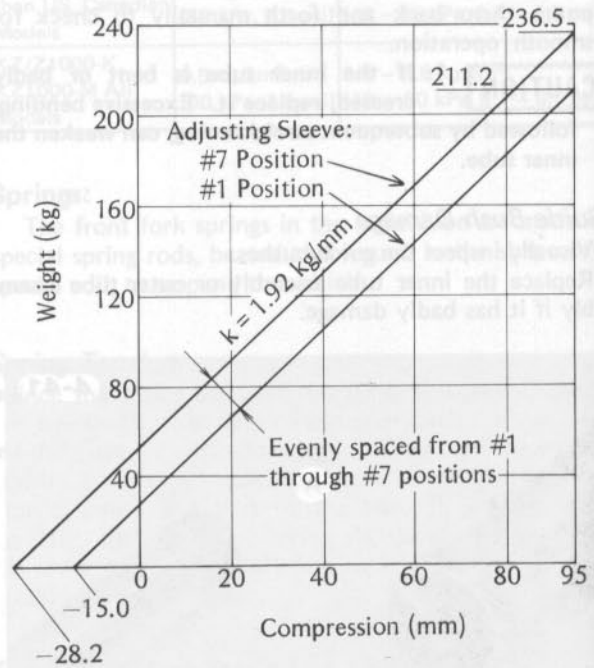

(2)Z1000-J (European and Australian Models)

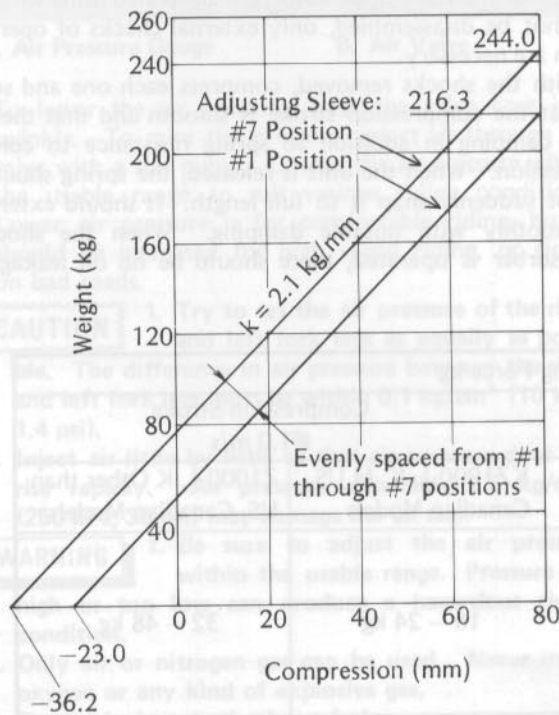

(4)Z1000-K (European Models)

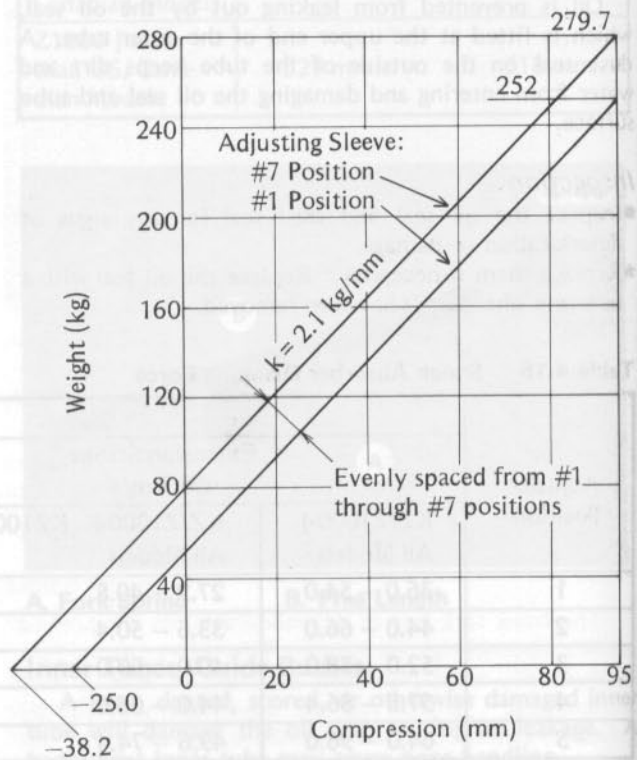

★If either shock absorber does not perform all of these operations satisfactorily, or if one unit feels weaker than the other, replace both shock absorbers as a set. If only one unit is replaced and the two are not balanced, motorcycle instability at high speeds may result.

●Check the rubber bushings.

★Replace any that are worn, cracked, hardened, or otherwise damaged.

**Spring Force:**

The spring adjusting sleeve on each rear shock absorber has 7 positions so that the spring can be adjusted for different road and loading conditions.

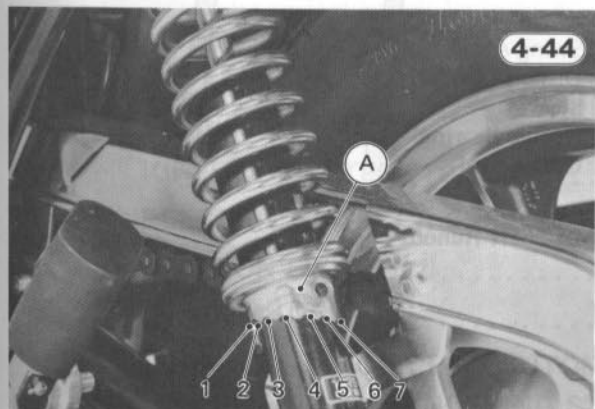

A. Spring Adjusting Sleeve

The spring force can be left soft for average riding. But it should be adjusted harder for high speed riding, or riding with a passenger. If the spring action feels too soft or too stiff, adjust it in accordance with the following table.

**Table 4-17 Spring Action**

Position	1	2	3	4	5	6	7
Spring Action	Stronger →						

**Spring Force Adjustment**

●Turn the adjusting sleeve on each shock absorber to the desired position with a screwdriver bit.

●Check to see that both adjusting sleeves are turned to the same relative position.

**WARNING** 1. If both spring adjusting sleeves are not adjusted equally, handling may be impaired and a hazardous condition may result.

**Damping Force:**

The damper adjuster on each rear shock absorber has 5 positions so that the damping force can be adjusted for different road and loading conditions. The numbers on the adjuster show the setting position of the damper.

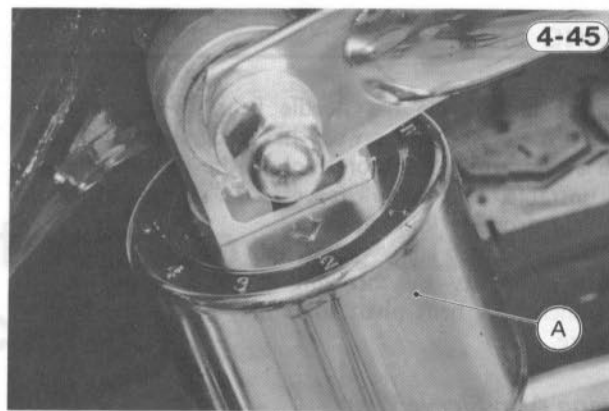

A. Damper Adjuster

The damping force can be left soft for average riding. But it should be adjusted harder for high speed riding, or riding with a passenger. If the damper setting feels too soft or too stiff, adjust it in accordance with the following table:

**Table 4-18 Damping Force**

Position	1	2	3	4	5
Damping Force	Larger →				

**Damping Force Adjustment**

●Turn the adjuster to the desired number until you feel a click.

●Check to see that both adjuster are turned to the same relative position.

**WARNING** 1. If both damper adjusters are not adjusted equally, handling may be impaired and a hazardous condition may result.

**Rear Shock Absorber Setting:**

Table 4-19 shows an example of setting for the rear shock absorbers. To obtain the stable handling or suitable riding condition, adjust the spring force and damping force for different road and loading conditions if necessary. For instance, setting "A" shown in the table is softest and designed for an average-built rider of 68 kg (150 lbs) with no accessories. Ordinarily, the heavier the total load becomes, the harder the suspension should be set.

**Table 4-19 Rear Shock Absorber Setting (example)**

Suspension Setting	Rear Shock Absorber	
	Spring Force (Sleeve Position)	Damping Force (Adjuster Position)
Soft ↑ ↓ Hard	A	1 or 2
	B	2 or 3
	C	2 or 3
	D	3 or 4
	E	3 or 4
	F	4 or 5



## SWING ARM

This motorcycle has needle bearings at the swing arm pivot. If bearing wear has progressed such that the swing arm has become loose, the motorcycle will be unstable. To minimize wear, the swing arm should be kept properly lubricated.

A bent pivot shaft or twisted swing arm will also cause instability by throwing the rear wheel out of alignment. A bent pivot shaft may also cause bearing seizure.

### Swing Arm Sleeve Wear

- Remove the swing arm, and pull the swing arm sleeves out of the pivot.
- Measure the outside diameter of the swing arm sleeves with a micrometer.
- ★ Replace all the sleeves and need bearings, if the diameter of any sleeve is less than the service limit or if it shows visible damage.

Table 4-20 Sleeve Outside Diameter

Standard	Service Limit
24.987 – 25.000 mm	24.96 mm

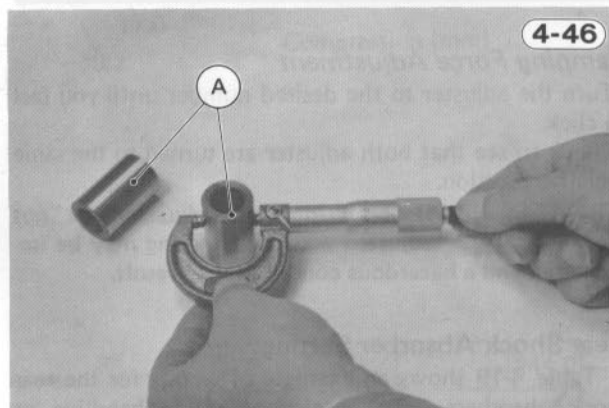

4-46

A. Swing Arm Sleeves

### Swing Arm Bearing Damage

- The rollers in the needle bearings wear so little that the wear is difficult to measure. Instead, inspect the needle bearings for abrasions, color change, or other damage.
- ★ If there is any doubt as to its the condition of either needle bearing, replace all the needle bearings and swing arm sleeves.

### Pivot Shaft Runout

- To measure the pivot shaft runout, set the pivot shaft on V blocks at the end of the pivot shaft, and set a dial gauge to the shaft halfway between the blocks.
- Turn the shaft to measure the runout. The amount of runout is the amount of dial variation.
- ★ If the shaft runout exceeds the usable range, straighten it. If it cannot be straightened, or if the runout exceeds the service limit, replace the shaft.

Table 4-21 Pivot Shaft Runout

Standard	Usable Range	Service Limit
under 0.10 mm	under 0.14 mm	0.7 mm

### Swing Arm Pivot

4-47

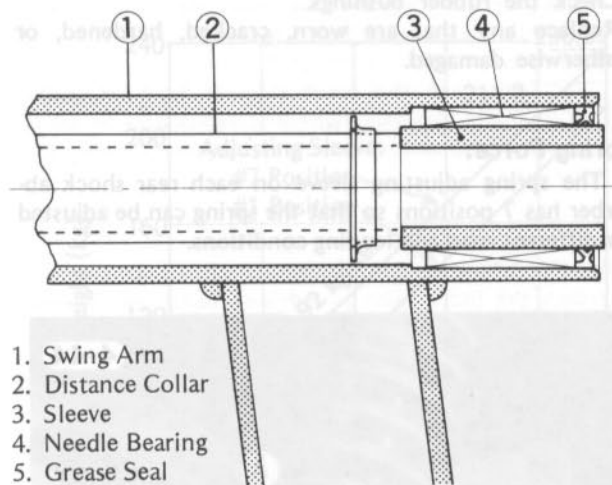

1. Swing Arm
2. Distance Collar
3. Sleeve
4. Needle Bearing
5. Grease Seal

### Pivot Shaft Runout

4-48

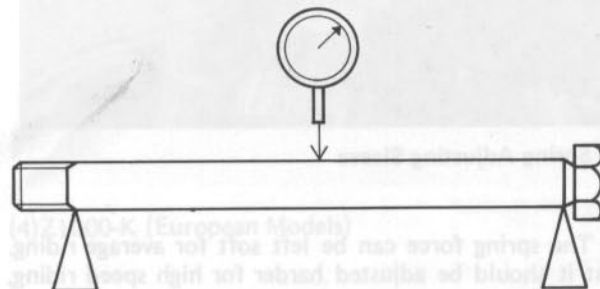

## DRIVE CHAIN

### Cleaning

Dirt will cling to the oil and act as an abrasive, accelerating chain wear. Whenever the chain becomes particularly dirty, it must be cleaned.

**CAUTION** The O-rings between the side plates seal in the lubricant between the pin and the bushing. To avoid damaging the O-rings and resultant loss of lubricant, observe the following rules.

1. Use only kerosen or diesel oil for cleaning an O-ring drive chain. Any other cleaning solution such as gasoline or trichloroethylene will cause deterioration and swell of the O-rings.
2. Immediately blow the chain dry with compressed air after cleaning.
3. Complete cleaning and drying the chain within 10 minutes.
4. Lubricate the chain after cleaning and drying.

# Non-scheduled Maintenance – Electrical

## Table of Contents

### Initial Charge

New batteries for Kawasaki motorcycles are dry charged and can be used directly after adding the electrolyte. However, the effect of the dry charge deteriorates somewhat during storage, especially if any air has entered the battery from imperfect sealing.

Therefore, it is best to give the battery an initial charge before use to extend its life.

- 1. Cut the cap off the cells.
- 2. Remove the caps from the cells.
- 3. Pour the electrolyte into the battery up to the upper level.
- 4. Let the battery stand for 1 hour.
- NOTE: If the temperature is 30°C or higher, the battery should be charged before pouring it into the battery.
- 2. After the battery is fully charged, the battery should be used.

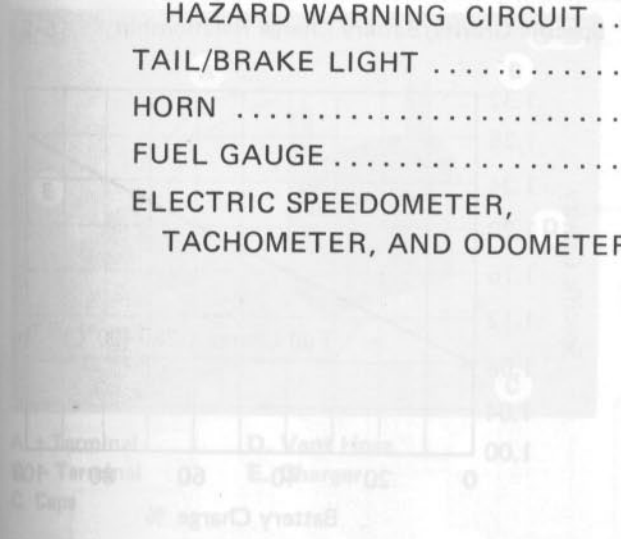

Leaving the caps off the cells, connect the battery to a charger, set the charging rate at 1/10 the battery capacity, and charge it for 10 hours. For example, if the battery is rated at 18AH, the charging rate would be 1.8 amperes. If a constant voltage charger is used, the voltage must be adjusted to maintain the current at a constant value.

**CAUTION** During charging, the temperature of the electrolyte will rise. Therefore, the charging rate should be reduced if the temperature rises above 40°C (104°F). The charging rate should be increased if the temperature is below 10°C (50°F). The temperature of the electrolyte should be maintained between 10°C and 40°C.

BATTERY .....	5-2
CHARGING SYSTEM .....	5-4
IGNITION SYSTEM .....	5-8
ELECTRIC STARTER SYSTEM .....	5-15
IGNITION SWITCH .....	5-19
HEADLIGHT .....	5-20
TURN SIGNAL CIRCUIT, AUTOMATIC TURN SIGNAL CANCELING SYSTEM, HAZARD WARNING CIRCUIT .....	5-24
TAIL/BRAKE LIGHT .....	5-28
HORN .....	5-30
FUEL GAUGE .....	5-31
ELECTRIC SPEEDOMETER, TACHOMETER, AND ODOMETER .....	5-33

## BATTERY

The battery supplies the current to the starter motor and serves as a back-up source of power to operate the electrical equipment whenever the engine is turning over too slowly for the alternator to supply sufficient power.

With proper care, the battery can be expected to last several years, but it may be completely ruined long before that if it is mistreated. Following a few simple rules will greatly extend the life of the battery.

1. When the level of the electrolyte in the battery is low, add only distilled water to each cell, until the level is at the upper level line marked on the outside of the battery. Ordinary tap water is not a substitute for distilled water and will shorten the life of the battery.
2. Never add sulphuric acid solution to the battery. This will make the electrolyte solution too strong and will ruin the battery within a very short time.
3. Avoid quick-charging the battery. A quick-charge will damage the battery plates.
4. Never let a good battery stand for more than 30 days without giving it a supplemental charge, and never let a discharged battery stand without charging it. If a battery stands for any length of time, it slowly self-discharges. Once it is discharged, the plates sulphate (turn white), and the battery will no longer take a charge.
5. Keep the battery well-charged during cold weather so that the electrolyte does not freeze and crack open the battery. The more discharged the battery becomes, the more easily it freezes.
6. Always keep the battery vent hose free of obstruction, and make sure it does not get pinched, crimped, or melted shut by contact with the hot muffler. If battery gases cannot escape through this hose, they will explode the battery.
7. **DON'T INSTALL THE BATTERY BACKWARDS.** The negative side is grounded.

### Electrolyte:

The electrolyte is dilute sulphuric acid. The standard specific gravity of the electrolyte is 1.280 at 20°C (68°F). The water in this solution changes to a gaseous mixture due to chemical action in the battery and escapes, which concentrates the acid in a charged battery. Consequently, when the level of the electrolyte becomes low, only distilled water should be added. If sulphuric acid is added, the solution will become too strong for proper chemical action and will damage the plates. Metal from the damaged plates collects in the bottom of the battery. This sediment will eventually cause an internal short circuit.

The specific gravity of the electrolyte is measured with a hydrometer and is the most accurate indication of the condition of the battery. When using the hydrometer, read the electrolyte level at the bottom of the meniscus (curved surface of the fluid). Fig. 5-2 shows the relationship between the specific gravity of the solution at 20°C (68°F) and the percentage of battery charge. Since specific gravity varies with temperature, and since the temperature of the solution being checked is likely to be other than 20°C (68°F); the formula given below should be used to compute what the

specific gravity will be at any temperature. When the temperature goes up, the specific gravity goes down, and vice versa.

Generally speaking, a battery should be charged if a specific gravity reading shows it to be discharged to 50% or less of full charge.

Hydrometer

5-1

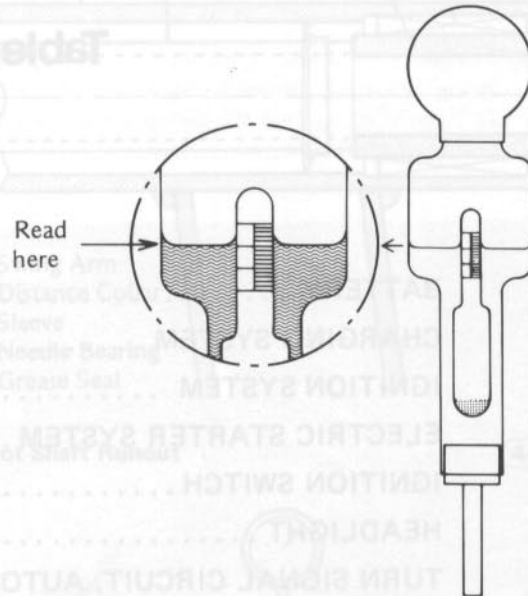

Specific Gravity/Battery Charge Relationship

5-2

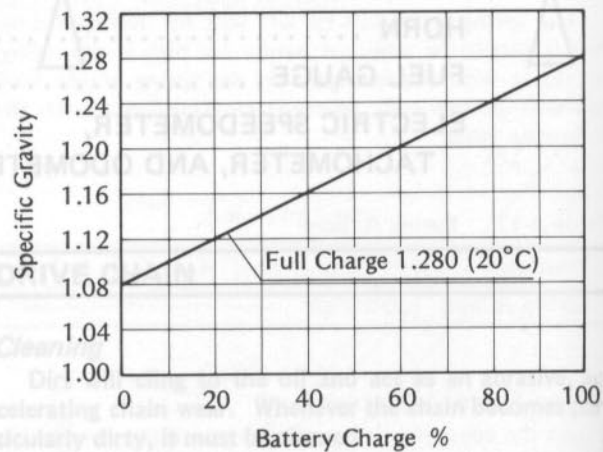

oCelsius

$$S_{20} = S_t + [0.0007 (t - 20)]$$

oFahrenheit

$$S_{68} = S_t + [0.0004 (t - 68)]$$

$S_t$  = specific gravity at the present temperature

$S_{20}$  = specific gravity at 20°C

$S_{68}$  = specific gravity at 68°F

$t$  = present temperature of solution

### Battery Charging:

- WARNING** 1. Because the battery gives off an explosive gas mixture of hydrogen and oxygen, keep any sparks or open flame away from the battery during charging.
2. When using a battery charger, connect the battery to the charger before turning on the charger. This procedure prevents sparks at the battery terminals which could ignite any battery gases.

### Initial Charge

New batteries for Kawasaki motorcycles are dry charged and can be used directly after adding the electrolyte. However, the effect of the dry charge deteriorates somewhat during storage, especially if any air has entered the battery from imperfect sealing.

Therefore, it is best to give the battery an initial charge before using it in order to ensure long battery life.

- Cut off the plugged end of the battery vent hose.
- Remove the caps from all the cells.
- Pour a 1.280 (specific gravity at 20°C or 68°F) sulphuric acid solution into each cell of the battery up to the upper level line.
- Let the battery stand for 30 minutes, adding more acid if the level drops during this time.

**NOTE:** 1. If the temperature of the solution is over 30°C (85°F), cool the solution before pouring it into the battery.

2. After pouring the acid into the battery, start charging the battery within 12 hours.

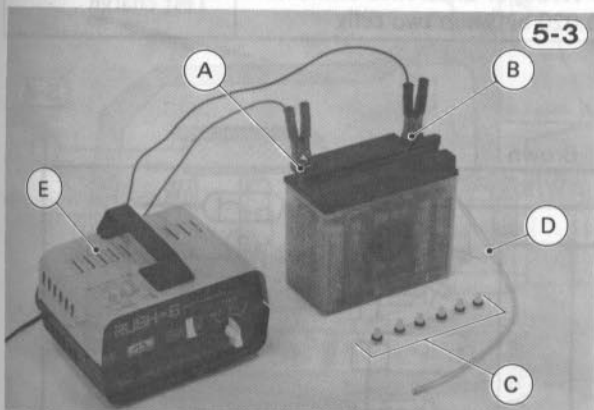

A. + Terminal  
B. - Terminal  
C. Caps  
D. Vent Hose  
E. Charger

- Leaving the caps off the cells, connect the battery to a charger, set the charging rate at 1/10 the battery capacity, and charge it for 10 hours. For example, if the battery is rated at 18AH, the charging rate would be 1.8 ampere. If a constant voltage charger is used, the voltage must be adjusted periodically to keep the current at a constant value.

**CAUTION** 1. If the temperature of the electrolyte rises above 45°C (115°F) during charging reduce the charging rate to bring down the temperature, and increase the charging time proportionately.

- After charging, check the electrolyte level in each cell. If the level has dropped, add distilled water to bring it back up to the upper level line.
- Check the results of charging by measuring the specific gravity of each cell and by measuring battery voltage. Battery voltage of a 12 volt battery directly after the completion of charging should be 15 to 16 volts.

### Ordinary Charge

- Remove the battery from the motorcycle.

**CAUTION** 1. Always remove the battery from the motorcycle for charging. If the battery is charged while still installed, battery electrolyte may spill and corrode the frame or other parts of the motorcycle.

- Clean off the battery using a solution of baking soda and water. Make especially sure that the terminals are clean.
- Remove the caps from all the cells.
- Before charging, check the electrolyte level in each cell.
- ★ If the electrolyte level is low in any cell, fill to over the lower level line but not up to the upper level line since the level rises during charging.
- Figure the charging rate to be between 1/10 and 3/10 of battery capacity. For example, the maximum charging rate for a 18AH battery would be 3/10 x 18 which equals 5.4 amperers.

**CAUTION** 1. Charging the battery at a rate higher than specified above could ruin the battery. Charging at a higher rate causes excess heat, which can warp the plates and cause internal shorting. Higher than normal charging rates also cause the plates to shed active material. Deposits will accumulate, and can cause internal shorting.

- Measure the specific gravity of the electrolyte, and use the graph, Fig. 5-2, to determine the percentage of discharge. Multiply the capacity of the battery by the percentage of discharge to find the amount of discharge in ampere-hours (AH). Use this figure in the formula below to compute charging time.

$$\text{Charging time (hours)} = \frac{\text{Amount of discharge (AH)}}{\text{Charging current (A)}} \times 1.2 \sim 1.5$$

- Remove the caps from all the cells, and begin charging the battery at the rate just calculated. If a constant voltage charger is used, the voltage will have to be adjusted periodically to maintain charging current at a constant value.

**CAUTION** 1. If the temperature of the electrolyte rises above 45°C (115°F) during charging, reduce the charging rate to bring down the temperature, and increase charging time proportionately.

- After charging, check the electrolyte level in each cell.
- ★ If the level has dropped, add distilled water to bring it back up to the upper level line.
- Check charging results by measuring the specific gravity of each cell and by measuring battery voltage. Battery voltage of a 12 volt battery directly after the completion of charging should be 15 to 16 volts and the specific gravity of the electrolyte should be more than 1.250.

- ★If the voltage is lower than this, the battery is not completely charged or can no longer take a full charge. If the specific gravity of any one cell is lower than 1.250, there may be damage in the cell.
- Install the caps on the cells.
- Install the battery.

**Test Charging**

When the battery is suspected of being defective, first inspect the points noted in Table 5-1. The battery can be restored by charging it with the ordinary charger. If it will take a charge so that the voltage and specific gravity come up to normal, it may be considered good except in the following case:

- ★If the voltage suddenly jumps to over 13 volts just after the start of charging, the plates are probably sulphated. A good battery will rise to 12 volts immediately and then gradually go up to 12.5 – 13 volts in about 30 to 60 minutes after charging is started.
- ★If one cell produces no gas bubbles, or has a very low specific gravity, it is probably shorted.

- ★If there does not appear to be enough sediment to short the plates, but one cell has a low specific gravity after the battery is fully charged, the trouble may be just that there is insufficient acid, in that cell. In this instance only, sulphuric acid solution may be added to correct the specific gravity.
- ★If a fully charged battery not in use loses its charge after 2 to 7 days, or if the specific gravity drops markedly, the battery is defective. The self-discharge rate of a good battery is only about 1% per day.

**CHARGING SYSTEM**

The charging system consists of an alternator and an integrated regulator/rectifier.

The alternator generates the current required by the electrical circuits. The generated current is a three phase alternating current (AC), which is changed to direct

**Table 5-1 Battery Troubleshooting Guide**

	Good Battery	Suspect Battery	Action
Plates	(+) chocolate color (-) gray	white (sulphated); + plates broken or corroded	Replace
Sediment	none, or small amount	Sediment up to plates causing short	Replace
Voltage	above 12 volts	below 12 volts	Test charge
Electrolyte level	above plates	below top of plates	Fill and test charge
Specific gravity	above 1.200 in all cells; no two cells more than 0.020 different	below 1.100, or difference of more than 0.020 between two cells	Test charge

**Charging System**

(5-4)

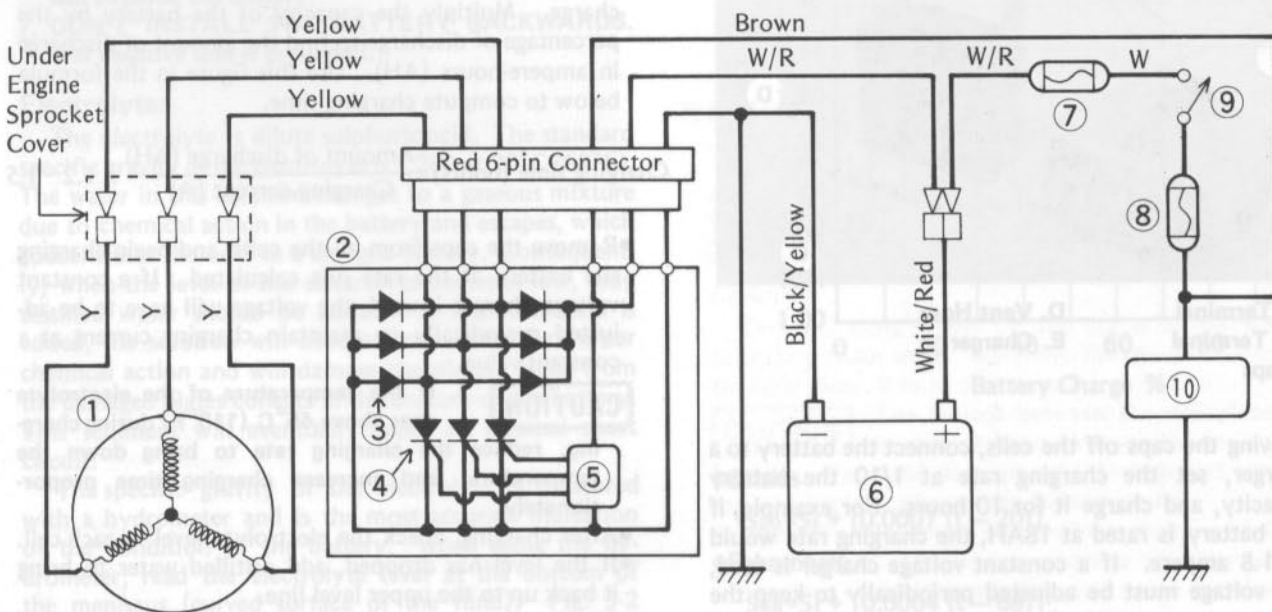

- |                        |                    |                    |
|------------------------|--------------------|--------------------|
| 1. Alternator          | 5. Control Circuit | 9. Ignition Switch |
| 2. Regulator/Rectifier | 6. Battery         | 10. Loads          |
| 3. Diodes              | 7. 30A Fuse        |                    |
| 4. Thyristors          | 8. 10A Fuse        |                    |

current (DC) and controlled by a solid-state regulator/rectifier to supply an even voltage to the circuit components.

There are number of important precautions that are musts when servicing the charging system. Cautions that apply to the individual parts are listed below. Failure to observe these rules can result in serious system damage. Learn and observe all the rules below.

**CAUTION** When handling the regulator/rectifier, observe the following to avoid damage to the regulator/rectifier:

1. Do not reverse the battery lead connections. This will burn out the diodes.
2. For the regulator/rectifier to function properly, the battery must be charged to near capacity. If the battery is badly discharged, charge it before installing it in the motorcycle.

When handling the alternator rotor:

3. The alternator rotor should never be struck sharply, as with a hammer, or allowed to fall on a hard surface. Such a shock to the rotor can cause the magnets to lose their magnetism.

#### Alternator:

The alternator is made of a rotor ① and stator ②. The stator is mounted in the alternator cover ③, while the

#### Alternator Construction

5-5

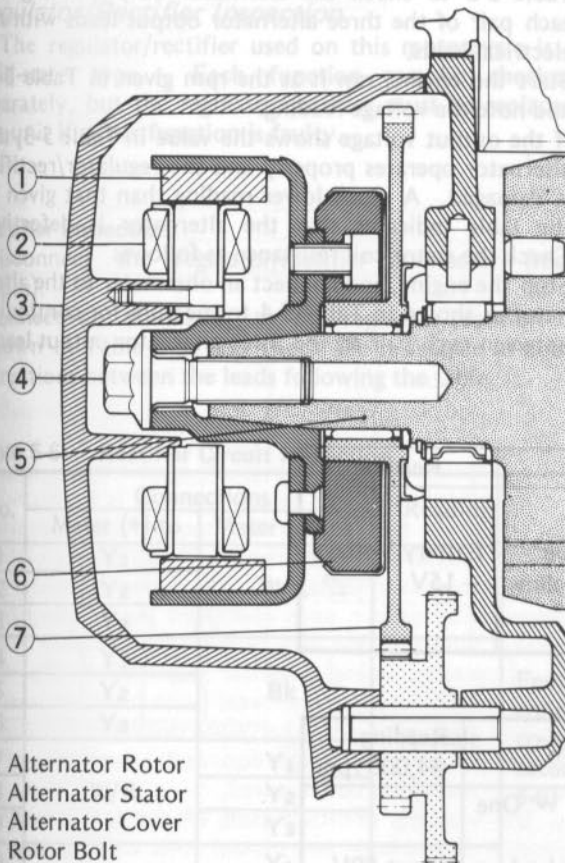

1. Alternator Rotor
2. Alternator Stator
3. Alternator Cover
4. Rotor Bolt
5. Crankshaft
6. Starter Clutch
7. Starter Clutch Gear

rotor is secured to the left end of the crankshaft and rotates at engine rpm. Permanent magnets in the rotor supply the magnetic field for the stator so that no slip rings or brushes are necessary, making the alternator practically maintenance free.

The stator consists of three sets of coils wound on laminated steel cores. These coils are connected in a Y-connection to produce a three-phase alternating current. Since the voltages of these three-phase overlap, there is a continuous, even supply of current for the circuit components.

#### Regulator/Rectifier:

The regulator and rectifier are solid-state type, and integrated into one unit. Since it contains no contacts or other moving parts, it does not wear out and never needs to be adjusted. It is therefore manufactured as a sealed unit, and must be replaced as a unit should it become defective. The rectifier in the unit rectifies (changes to direct current, DC) the three-phase alternating current (AC) from the alternator. It contains six silicon diodes which are connected in a bridge circuit arrangement for efficient, full-wave rectification. The regulator in the unit keeps the battery + terminal voltage level to a maximum of the specified range. The control circuit in the diagram checks on the voltage level, and triggers the thyristors.

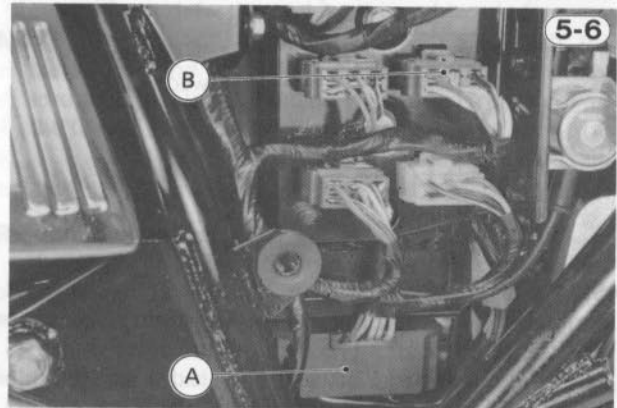

- A. Regulator/Rectifier  
B. Red, 6-pin, Regulator/Rectifier Connector

#### Charging System Inspection:

##### Initial Inspection

If there are any problem indications in the charging system, give the system a quick initial inspection or check before starting a series of time consuming tests, or worse yet, removing parts for repair or replacement. Such a check will often turn up the source of the trouble.

Make sure all connectors in the circuit are clean and tight. Check to see if the fuses have blown. Examine wires for signs of burning, fraying, etc. Poor wires and bad connections will affect electrical system operation. Check the alternator rotor and regulator/rectifier for evidence of physical damage.

A worn out or badly sulphated battery will produce numerous problems that cannot be corrected until the battery is replaced. **ALWAYS CHECK BATTERY CONDITION BEFORE CONDEMNING OTHER PARTS**

**OF THE SYSTEM. A FULLY CHARGED BATTERY IS A MUST FOR CONDUCTING ACCURATE CHARGING SYSTEM TESTS.**

Charging system malfunctions can be traced to either the battery, alternator, regulator/rectifier, or the wiring. Troubles may involve one item or in some cases all items. Never replace a defective part without determining what **CAUSED** the failure. If the failure was brought on by some other item or items, they too must be repaired or replaced, or the new replacement will soon fail again.

**Operational Inspection of Charging System**

- Warm up the engine to obtain actual alternator operating conditions.
- Stop the engine and connect a voltmeter to the regulator/rectifier as shown in Table 5-2 to test the regulator/rectifier output voltage.

**CAUTION** 1. The white/red lead is connected directly to the battery positive (+) terminal even when the ignition switch is off so take care not to short the meter probes or clips to the chassis ground.

**Lead Location in Regulator/Rectifier Connector**

5-7

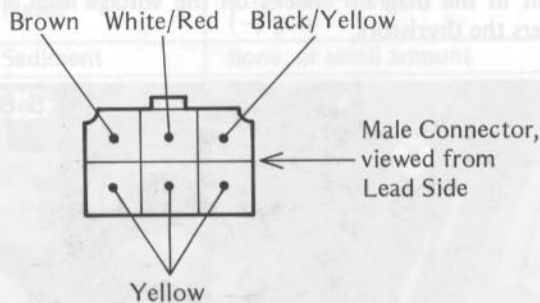

- Start the engine, and note the voltage readings at various engine speeds with the headlight turned on and then turned off. (To turn off the headlight of US model disconnect the black/yellow lead from the headlight unit in the headlight housing.) The readings

should show nearly battery voltage when the engine speed is low, and, as the engine speed rises, the readings should also rise. But they must be kept under the specified voltage.

- Turn off the ignition switch to stop the engine, and disconnect the voltmeter.
- ★ If the regulator/rectifier output voltage are kept between the values given in Table 5-2, the charging system is considered to be working normally.
- ★ If the output voltage is much higher than the values specified in the table, the regulator/rectifier is defective or the regulator/rectifier leads are loose or open.
- ★ If the battery voltage does not rise as the engine speed increases, then the regulator/rectifier is defective or the alternator output is insufficient for the loads. Check the alternator and regulator/rectifier to determine which part is defective.

**Alternator Inspection**

There are three types of alternator failures: short, open (wire burned out), or loss in rotor magnetism. A short or open in one of the coil wires will result in either a low output, or no output at all. A loss in rotor magnetism, which may be caused by dropping or hitting the alternator, by leaving it near an electromagnetic field, or just by aging, will result in low output.

- Disconnect the regulator/rectifier connector (red, 6-pin). See Fig. 5-6.
- Connect a voltmeter to the alternator as shown in Table 5-3 to check the alternator output voltage of each pair of the three alternator output leads with no electrical loads.
- Start the engine, run it at the rpm given in Table 5-3, and note the voltage reading.
- ★ If the output shows the value in Table 5-3, the alternator operates properly and the regulator/rectifier is damaged. A much lower reading than that given in the table indicates that the alternator is defective. Check the stator coil resistance as follows:
- Stop the engine, and connect an ohmmeter to the alternator as shown in Table 5-4 to measure for continuity between each pair of the three alternator output leads.

**Table 5-2 Regulator/Rectifier Output Voltage**

Meter Range	Lead Location	Connections	Reading
25V DC	Male, regulator/rectifier connector under left side cover with female connector connected (Fig. 5-6)	Meter (+) → White/Red Meter (-) → Black/Yellow	Battery Voltage - 15V

**Table 5-3 Alternator Output Voltage**

Meter Range	Lead Location	Connections	Reading @4,000 rpm
250V AC	Male, regulator/rectifier connector under left side cover with female connector disconnected (Fig. 5-6)	One meter lead → One yellow lead The other meter lead → Another yellow lead (Total of 3 measurements)	about 50V

Table 5-4 Stator Coil Resistance

Meter Range	Lead Location	Connections	Reading
$\times 1 \Omega$	Male, regulator/rectifier connector under left side cover with female connector disconnected (Fig. 5-6)	One meter lead $\rightarrow$ One yellow lead The other meter lead $\rightarrow$ Another yellow lead (Total of 3 measurements)	0.36 – 0.54 $\Omega$

- \*If there is more resistance than shown in Table 5-4, or no meter reading (infinity) for any two leads; the stator has an open lead, or there are poor wires or bad connections between the regulator/rectifier connector and the alternator stator. Replace the damaged parts.
- \*Much less than this resistance means the stator or the wires between the regulator/rectifier connector and the alternator stator are shorted, and must be replaced.
- Using the highest resistance range of the ohmmeter, measure the resistance between each of the yellow leads and chassis ground.
- \*Any meter reading less than infinity ( $\infty$ ) indicates a short, necessitating stator replacement.
- \*If the stator coils have normal resistance, but the voltage check showed the alternator to be defective; then the rotor magnets have probably weakened, and the rotor must be replaced.

### Regulator/Rectifier Inspection

The regulator/rectifier used on this motorcycle is a solid-state type. Each function can be checked separately, but the regulator/rectifier must be replaced as a unit if either function is faulty.

#### Rectifier inspection:

- Disconnect the regulator/rectifier connector (red, 6-pin).
- Connect an ohmmeter to the regulator/rectifier as shown in Table 5-5, and check the resistance in both directions between the leads following the table.

Table 5-5 Rectifier Circuit Inspection

No.	Connections		Reading	Lead Location	Meter Range
	Meter (+) to	Meter (-) to			
1	Y <sub>1</sub>	W/R	$\infty$	Female regulator/rectifier connector under left side cover with male connector disconnected (Fig. 5-6)	$\times 10 \Omega$ or $\times 100 \Omega$
2	Y <sub>2</sub>				
3	Y <sub>3</sub>				
4	Y <sub>1</sub>	Bk	$\frac{1}{3}$ scale		
5	Y <sub>2</sub>				
6	Y <sub>3</sub>				
7	W/R	Y <sub>1</sub>	$\infty$		
8		Y <sub>2</sub>			
9		Y <sub>3</sub>			
10	Bk	Y <sub>1</sub>	$\infty$		
11		Y <sub>2</sub>			
12		Y <sub>3</sub>			

### Lead Location in Regulator/Rectifier Connector

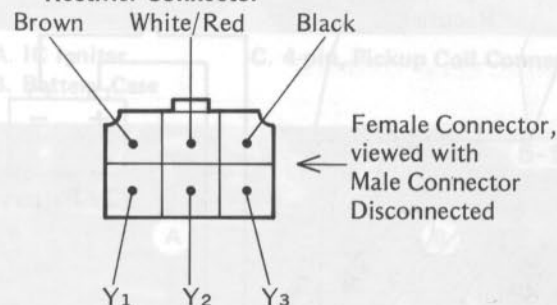

5-8

- \*The resistance should be low in one direction and more than ten times as much in the other direction. If any two leads are low or high in both directions, the rectifier is defective and must be replaced.

**NOTE:** 1. The actual meter reading varies with the meter used and the individual rectifier, but, generally speaking the lower reading should be from zero to the first 1/3 of the scale.

#### Regulator inspection:

If the rectifier is good, next test the regulator out of circuit.

- Disconnect the regulator/rectifier connector (red, 6-pin).
- Connect the test light (12V 3 – 6W) and 12-volt battery to the rectifier/regulator as shown in Fig. 5-9. Check each yellow lead.



**CAUTION** 1. The test light works as an indicator and also a current limiter to protect the regulator/rectifier from excessive current. Do not use an ammeter instead of a test light.

**Regulator Test 1**

5-9

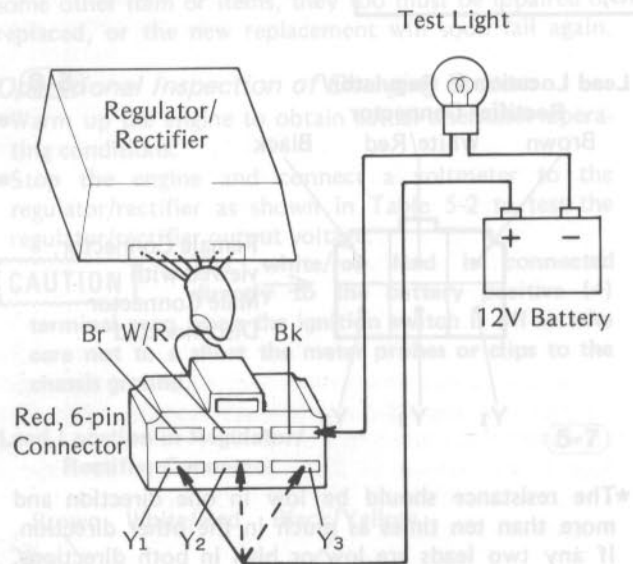

- ★At this time the test light should not be lit. If it goes on when any yellow lead is tested, the thyristor is shorted and the regulator/rectifier must be replaced.
- Apply 12 volts, and then 24 volts to the brown and the black leads as shown in Table 5-6. Check each yellow lead.

**CAUTION** 1. Do not apply more than 24 volts. If more than 24 volts is applied, the regulator/rectifier may be damaged. Do not apply 24 V more than a few seconds. If 24 volts is applied for more than a few seconds, the regulator/rectifier may be damaged.

**Table 5-6 Regulator Test 2**

No.	Battery Connections	Test Light
1	12 volt (+) → Brown 12 volt (-) → Black	goes off.
2	24 volt (+) → Brown 24 volt (-) → Black	goes on and stays on until bulb circuit is open.

★The test light should be turned on and off as indicated in the table. If it does not, replace the regulator/rectifier.

**NOTE:** 1. The above test is not foolproof. If the above checks show the regulator/rectifier is not damaged, but there is still trouble in the charging system, first carefully inspect the alternator, battery, wiring, and all connections. Replace the regulator/rectifier if all these other components turn out good.

**Regulator Test 2**

5-10

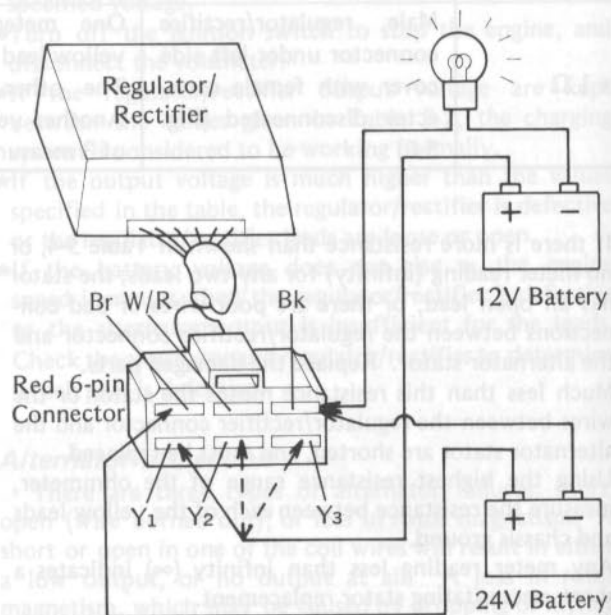

**IGNITION SYSTEM**

**Introduction:**

The ignition system for this model is essentially a battery and coil ignition system where the battery supplies the current for the primary circuit in the ignition system. However, this ignition system is transistorized and controls the current for the primary circuit by use of a solid-state electronic switching unit called a Darlington power transistor. The power transistors are triggered by pickup coils and there are no mechanical breaker points, so the only periodic maintenance needed is automatic timing advancer lubrication (Pg. 2-5). Since contact breaker heel wear (with resultant retarded ignition timing) and breaker point pitting or burning are eliminated, periodic inspection and adjustment of the ignition timing are not required.

The working electrical part of the ignition system consists of a battery, two pickup coils, an IC igniter, two ignition coils, and four spark plugs. To advance the ignition timing as engine rpm rises, an automatic centrifugal-type timing advancer is used. Each spark plug fires every

time the piston rises. However, if a spark does jump across the electrodes during the exhaust stroke, it has no effect on engine operation since there is no compression and no fuel to burn.

The ignition system comprises two parts; one part fires #1 and #4 cylinders, and the other part #2 and #3 cylinders. A schematic wiring diagram of the system is shown in Fig. 5-14.

**Main Component Parts:**

The locations of the main component parts and wiring connectors of the ignition system are shown in Fig. 5-11 through 5-13 and Fig. 5-15.

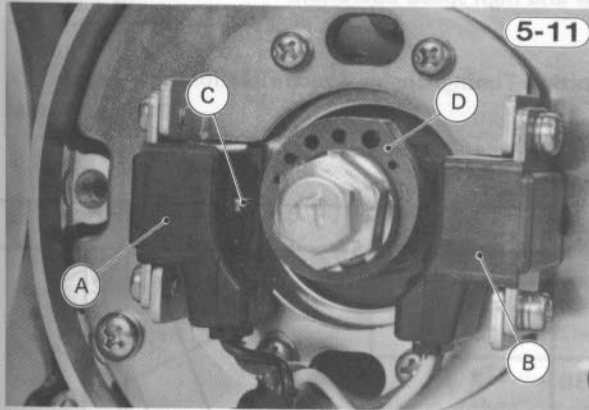

5-11  
A. Pickup Coil for #1 and #4 Cylinders  
B. Pickup Coil for #2 and #3 Cylinders  
C. Permanent Magnet  
D. Timing Rotor

**Ignition System**

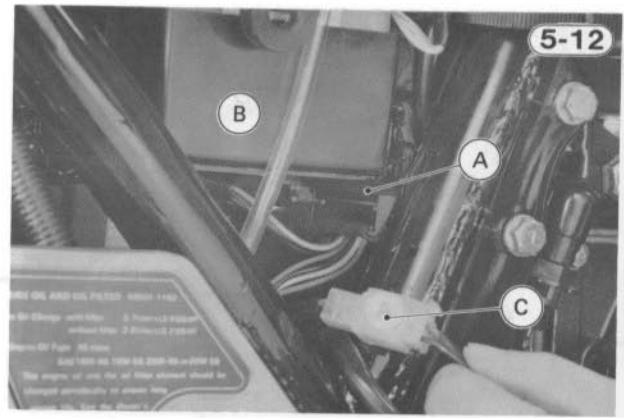

5-12  
A. IC Igniter  
B. Battery Case  
C. 4-pin, Pickup Coil Connector

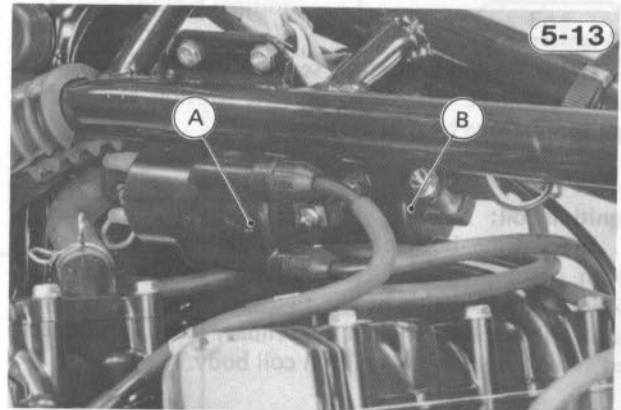

5-13  
A. Ignition Coil for #1 and #4 Cylinders  
B. Ignition Coil for #2 and #3 Cylinders

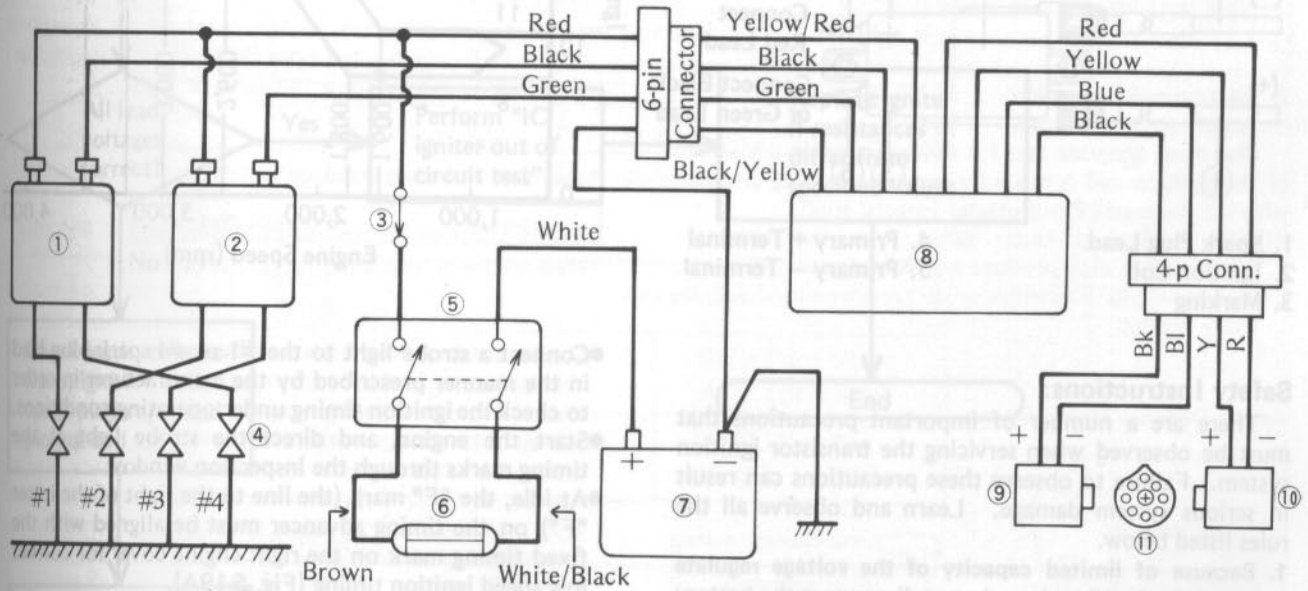

5-14  
1. Ignition Coil for #1 and #4 cylinders  
2. Ignition Coil for #2 and #3 cylinders  
3. Engine Stop Switch  
4. Spark Plugs  
5. Ignition Switch  
6. 10A Fuse  
7. Battery  
8. IC Igniter  
9. Pickup Coil for #1 and #4 cylinders  
10. Pickup Coil for #2 and #3 cylinders  
11. Timing Rotor

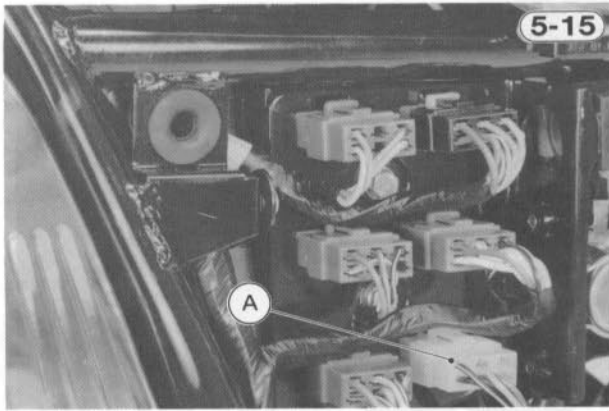

5-15

A. 6-pin IC Igniter Connector

**IC igniter:**

If the pickup coil stops sending signals, the primary current will be cut off to prevent ignition coil and IC igniter damage by overheating.

**Ignition coil:**

Every time both pistons rise, the ignition coil fires both spark plugs simultaneously which are connected series. The polarity of the two spark plug leads are as shown in the figure when the primary leads are connected as indicated on the ignition coil body.

**Polarity of Ignition Coil**

5-16

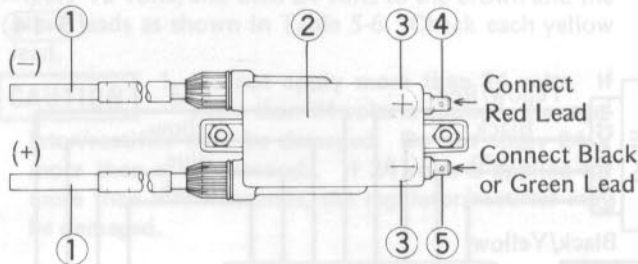

- 1. Spark Plug Lead
- 2. Ignition Coil
- 3. Marking
- 4. Primary + Terminal
- 5. Primary - Terminal

**Safety Instructions:**

There are a number of important precautions that must be observed when servicing the transistor ignition system. Failure to observe these precautions can result in serious system damage. Learn and observe all the rules listed below.

1. Because of limited capacity of the voltage regulate circuit in the IC igniter, do not disconnect the battery leads or any other electrical connections when the ignition switch is on, or when the engine is running. This is to prevent IC igniter damage.
2. Do not install the battery backwards. The negative side is ground. This is to prevent damage to the diodes.

**Ignition System Troubleshooting Guide:**

If trouble is suspected in the ignition system, check the system by the following procedure.

An example of troubleshooting is shown in Fig. 5-18. To use this chart, follow the arrows on the chart selecting a "yes" or "no" arrow at each diamond-shaped step until you reach the "end". Each test procedure is explained individually. This chart is for one half of the ignition circuit; use the same chart for the other half.

**Description of each testing procedure:**

**1. Dynamic ignition timing test**

Check the ignition timing with a strobe light for both low and high speed operation.

**Ignition Timing/Engine Speed Relationship**

5-17

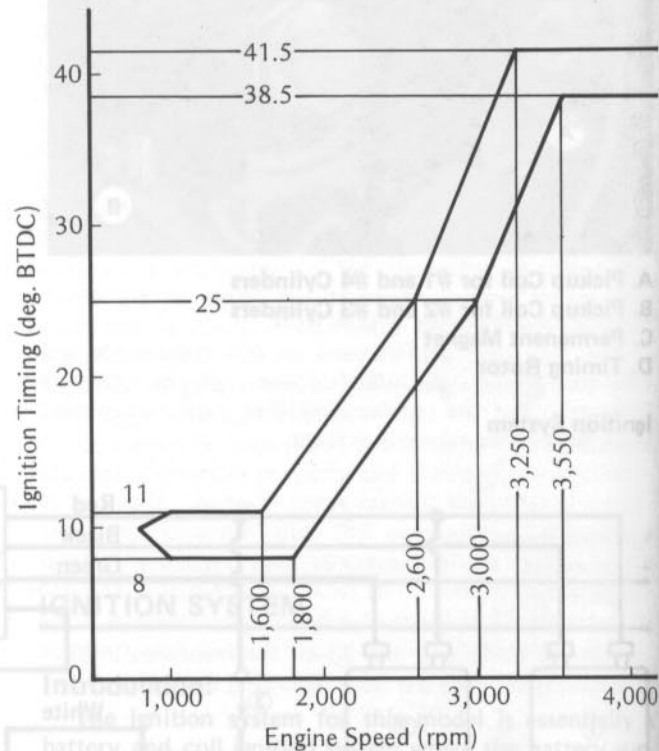

- Connect a strobe light to the #1 or #4 spark plug lead in the manner prescribed by the manufacturer in order to check the ignition timing under operating conditions.
- Start the engine, and direct the strobe light at the timing marks through the inspection window.
- At idle, the "F" mark (the line to the right of the letter "F") on the timing advancer must be aligned with the fixed timing mark on the right engine cover for correct low speed ignition timing (Fig. 5-19A).
- Raise the engine speed to 4,000 rpm, and check the ignition timing. At this time, the fixed timing mark should be between the advanced timing marks (a pair of the parallel lines to the right of "1.4" mark) on the timing advancer for correct high speed ignition timing (Fig. 5-19B).

Ignition System Troubleshooting Guide

5-18

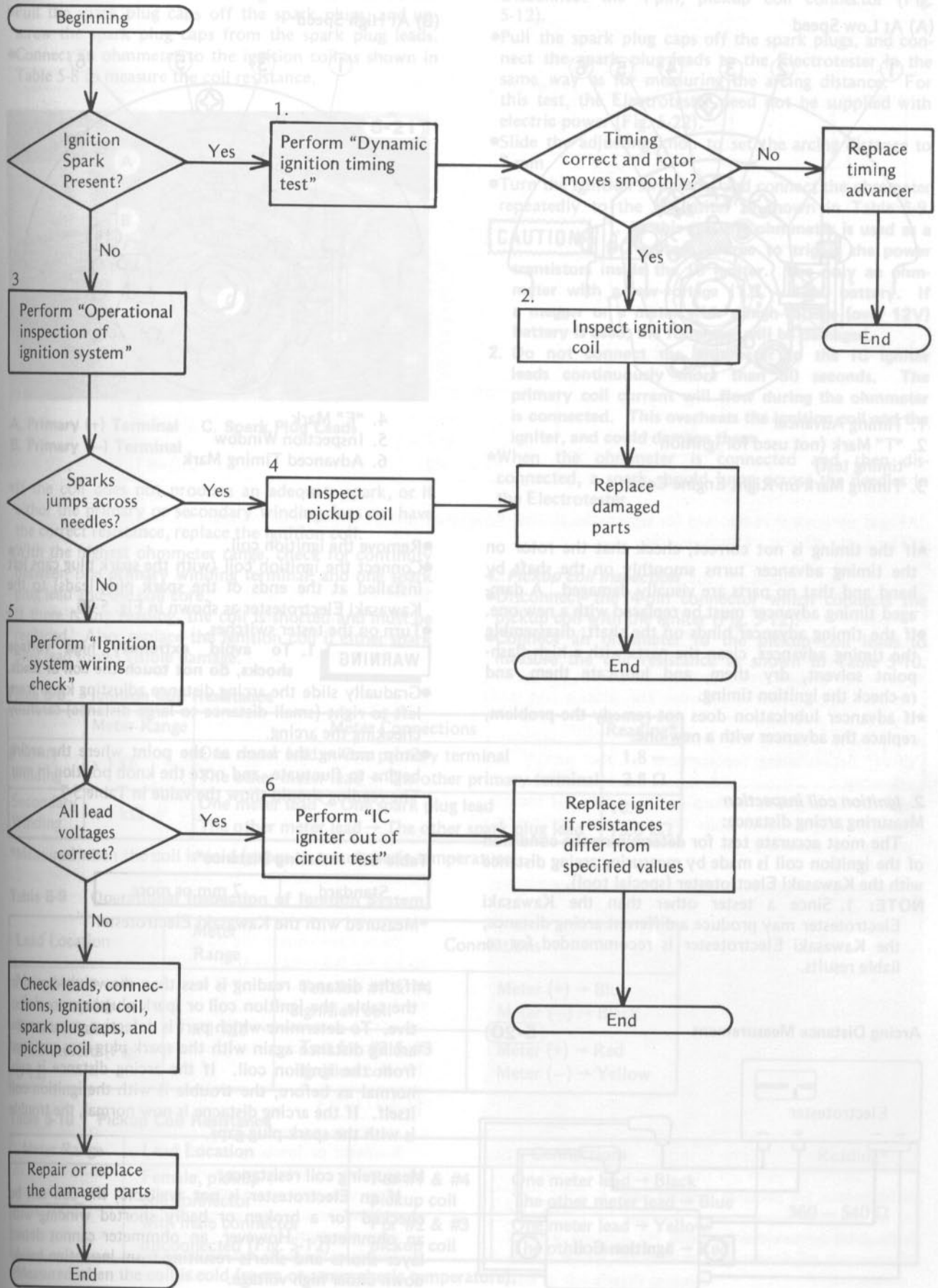

Timing Marks

(A) At Low Speed

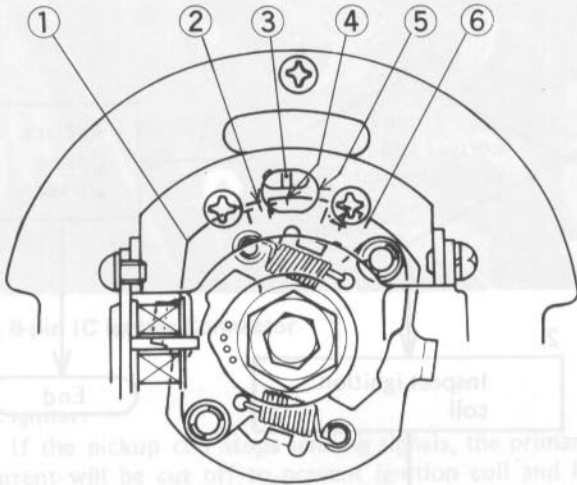

1. Timing Advancer
2. "T" Mark (not used for ignition timing test)
3. Timing Mark on Right Engine Cover

- ★If the timing is not correct, check that the rotor on the timing advancer turns smoothly on the shaft by hand and that no parts are visually damaged. A damaged timing advancer must be replaced with a new one.
- If the timing advancer binds on the shaft; disassemble the timing advancer, clean the parts with a high flash-point solvent, dry them, and lubricate them, and re-check the ignition timing.
- ★If advancer lubrication does not remedy the problem, replace the advancer with a new one.

2. Ignition coil inspection  
Measuring arcing distance:

The most accurate test for determining the condition of the ignition coil is made by measuring arcing distance with the Kawasaki Electrotester (special tool).

**NOTE:** 1. Since a tester other than the Kawasaki Electrotester may produce a different arcing distance, the Kawasaki Electrotester is recommended for reliable results.

Arcing Distance Measurement

5-20

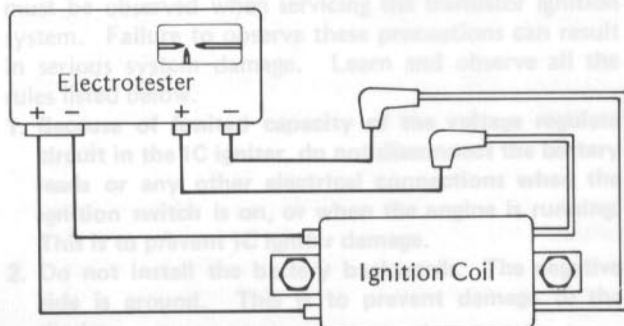

Ignition System (Continued) 5-19

(B) At High Speed

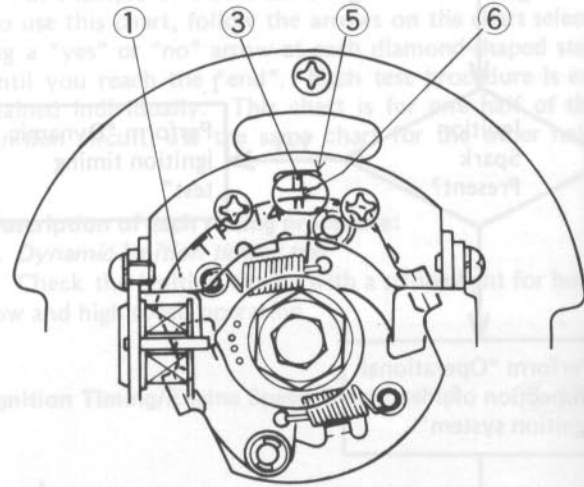

4. "F" Mark
5. Inspection Window
6. Advanced Timing Mark

- Remove the ignition coil.
  - Connect the ignition coil (with the spark plug caps left installed at the ends of the spark plug leads) to the Kawasaki Electrotester as shown in Fig. 5-20.
  - Turn on the tester switches.
- WARNING** 1. To avoid extremely high voltage shocks, do not touch the coil or leads.
- Gradually slide the arcing distance adjusting knob from left to right (small distance to large distance) carefully checking the arcing.
  - Stop moving the knob at the point where the arcing begins to fluctuate, and note the knob position in mm. The reading should show the value in Table 5-7.

Table 5-7 Arcing Distance\*

Standard	7 mm or more
----------	--------------

\*Measured with the Kawasaki Electrotester.

- ★If the distance reading is less than the value shown in the table, the ignition coil or spark plug caps are defective. To determine which part is defective, measure the arcing distance again with the spark plug caps removed from the ignition coil. If the arcing distance is sub-normal as before, the trouble is with the ignition coil itself. If the arcing distance is now normal, the trouble is with the spark plug caps.

Measuring coil resistance:

If an Electrotester is not available, the coil can be checked for a broken or badly shorted winding with an ohmmeter. However, an ohmmeter cannot detect layer shorts and shorts resulting from insulation breakdown under high voltage.

- Remove the fuel tank.
- Pull out the leads from the ignition coil terminals.
- Pull the spark plug caps off the spark plugs, and unscrew the spark plug caps from the spark plug leads.
- Connect an ohmmeter to the ignition coil as shown in Table 5-8 to measure the coil resistance.

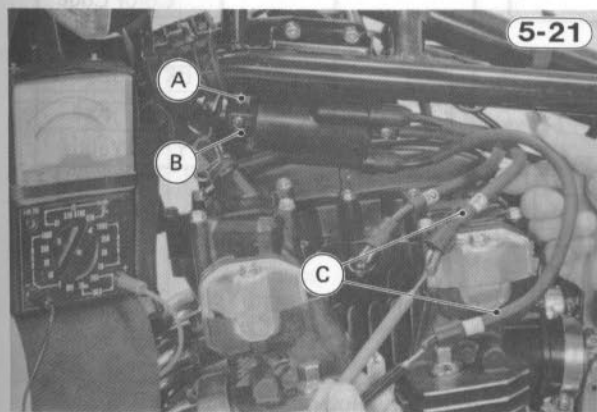

A. Primary (+) Terminal    C. Spark Plug Leads  
B. Primary (-) Terminal

- ★If the coil does not produce an adequate spark, or if either the primary or secondary winding does not have the correct resistance, replace the ignition coil.
- With the highest ohmmeter range, check for continuity between one primary winding terminal, and one spark plug lead and the coil core.
- ★If there is any reading, the coil is shorted and must be replaced. Also, replace the ignition coil if either spark plug lead shows visible damage.

Table 5-8 Ignition Coil Resistance

	Meter Range	Meter Connections	Reading*
Primary Winding	x 1 Ω	One meter lead → One primary terminal	1.8 –
		The other meter lead → The other primary terminal	2.8 Ω
Secondary Winding	x 1 kΩ	One meter lead → One spark plug lead	10.4 –
		The other meter lead → The other spark plug lead	15.6 kΩ

\*Measured when the coil is cold (room or atmospheric temperature).

Table 5-9 Operational Inspection of Ignition System

Lead Location	Meter Range	Connections	
Male, pickup coil connector with female connector disconnected (Fig. 5-12)	x 1 kΩ	Test for #1 & #4 ignition coil	Meter (+) → Blue Meter (-) → Black
		Test for #2 & #3 ignition coil	Meter (+) → Red Meter (-) → Yellow

Table 5-10 Pickup Coil Resistance

Meter Range	Lead Location	Connections	Reading*	
x 100 Ω	Female, pickup coil connector with male connector disconnected (Fig. 5-12)	For #1 & #4 pickup coil	One meter lead → Black The other meter lead → Blue	360 – 540 Ω
		For #2 & #3 pickup coil	One meter lead → Yellow The other meter lead → Red	

\*Measured when the coil is cold (room or atmospheric temperature).

### 3. Operational inspection of ignition system

- Disconnect the 4-pin, pickup coil connector (Fig. 5-12).
- Pull the spark plug caps off the spark plugs, and connect the spark plug leads to the Electrotester in the same way as for measuring the arcing distance. For this test, the Electrotester need not be supplied with electric power (Fig. 5-22).
- Slide the adjusting knob to set the arcing distance to 7 mm.
- Turn the ignition switch on, and connect the ohmmeter repeatedly to the IC igniter as shown in Table 5-9.

**CAUTION** 1. In this test the ohmmeter is used as a DC voltage source to trigger the power transistors inside the IC igniter. Use only an ohmmeter with a low-voltage (1.5 – 12V) battery. If a megger or a meter with a high-voltage (over 12V) battery is used, the IC igniter will be damaged.

2. Do not connect the ohmmeter to the IC igniter leads continuously more than 30 seconds. The primary coil current will flow during the ohmmeter is connected. This overheats the ignition coil and the igniter, and could damage them.

★When the ohmmeter is connected and then disconnected, a spark should jump across the needles in the Electrotester.

### 4. Pickup coil inspection

- Disconnect the 4-pin connector which connects the pickup coil with the igniter (Fig. 5-12).
- Connect an ohmmeter to the pickup coil leads to measure the coil resistance as shown in Table 5-10.

Operational Inspection of Ignition System

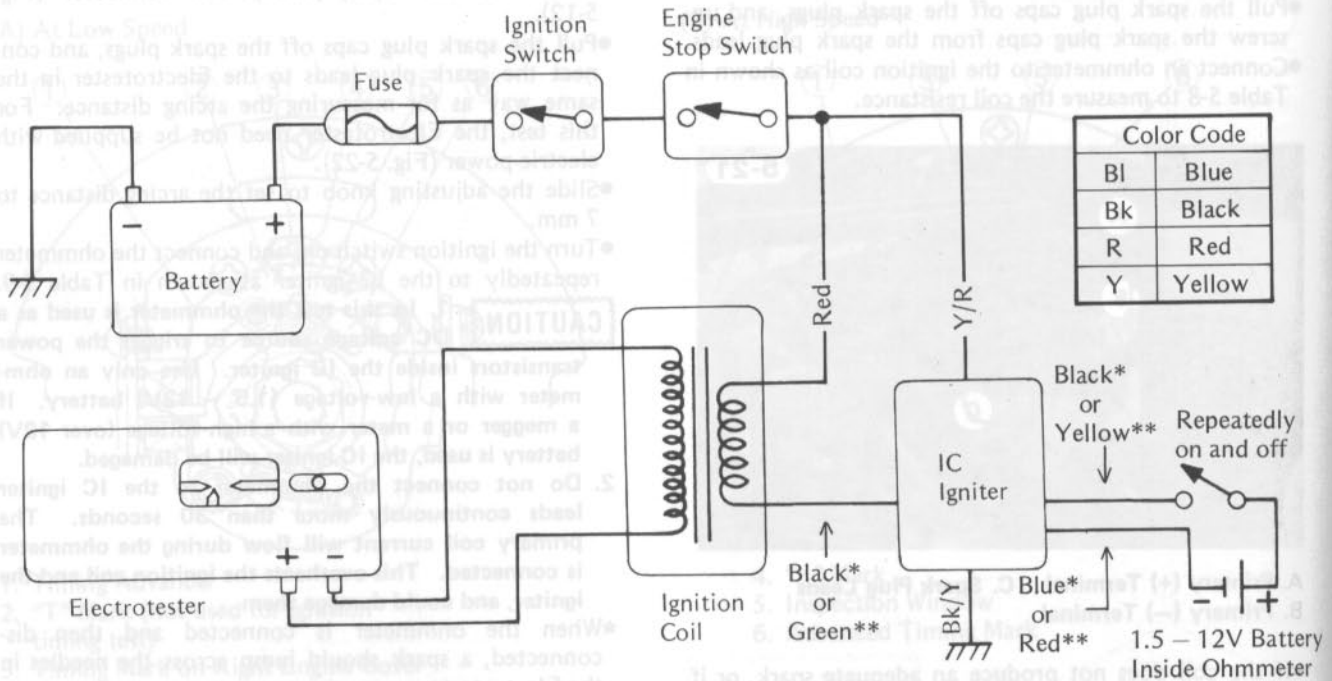

\*These are leads that are used for testing the #1 and #4 ignition coil of the ignition system.

\*\*These, for #2 and #3 ignition coil.

- ★ If there is more resistance than shown in the Table 5-10, the coil has an open lead and must be replaced. Much less than this resistance means the coil is shorted, and must be replaced.
- Using the highest resistance range of the ohmmeter, measure the resistance between the pickup coil leads and chassis ground.
- ★ Any meter reading less than infinity ( $\infty$ ) indicates a short, necessitating replacement of the pickup coil assembly.
- ★ Visually inspect the pickup coil assembly. If the permanent magnets and coils are damaged, replace the pickup coil assembly.

- Connect a voltmeter to the IC igniter leads as shown in Table 5-11, turn on the ignition switch, and note the meter readings. Measure the lead voltages with the engine stopped.

6. IC igniter out of circuit test

- Turn off the ignition switch, and disconnect the IC igniter connectors.
- Connect an ohmmeter as shown in Table 5-12 to check the internal resistance of the igniter.

Spark Plugs:

The spark plugs ignite the fuel/air mixture in the combustion chamber. To do this effectively and at the proper time, the correct spark plugs must be used, and the spark plugs must be kept clean and adjusted.

Tests have shown the plugs shown in Table 5-13, set to a 0.7 – 0.8 mm gap to be the best plug for general use.

If a plug of the wrong heat range is used, the electrodes may not hot enough to keep all the carbon burned off, but cool enough to keep from damaging the engine and the plug itself – about 400 – 800°C (750 – 1,450°F).

**CAUTION**

1. The carbon on the electrodes conducts electricity, and can short the center electrode to ground by either coating the ceramic insulator or bridging across the gap. Such a short will prevent an effective spark. Carbon build-up on the plug can also cause other troubles. It can heat up red-hot and cause preignition and knocking, which may eventually burn a hole in the top of the piston.
2. The heat range of the spark plug functions like a thermostat for the engine. Using the wrong type of spark

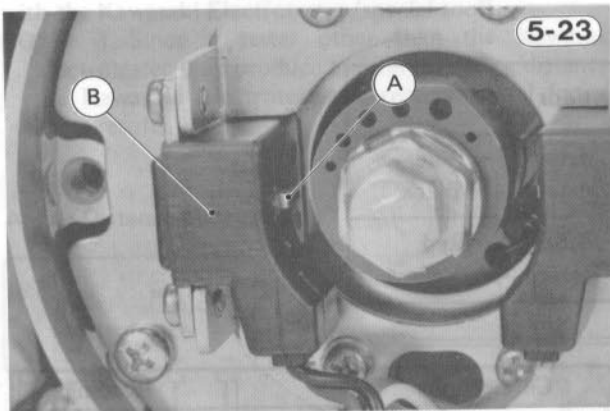

A. Magnet B. Pickup Coil

5. Ignition system wiring check

- Reconnect all leads and connectors which were disconnected.

1.  
2.  
3.

Table 5-11 Wiring Inspection

Meter Range	Connections*	Lead Location	Reading
25V DC	Meter (+) → Red, Black, or Green	6-pin Connector (Fig. 5-15)	Battery voltage
	Meter (+) → Black, Blue, Yellow, or Red	4-pin Connector (Fig. 5-12)	0.5 – 1.0 V

\*Connect the meter (–) lead to ground.

Table 5-12 Igniter Resistance

Meter Range	Lead Location	Connections	Reading*
x 1 k $\Omega$	Female, IC igniter connector with male connector disconnected (Fig. 5-15)	Meter (+) → Black/Yellow Meter (–) → Black, Green	$\infty$
x 100 $\Omega$		Meter (+) → Black, Green Meter (–) → Black/Yellow	200 – 500 $\Omega$
		Meter (+) → Red Meter (–) → Black/Yellow	200 – 600 $\Omega$
		Meter (+) → Black/Yellow Meter (–) → Red	300 – 700 $\Omega$
x 1 k $\Omega$	Male, pickup coil connector with female connector disconnected (Fig. 5-12)	Meter (+) → Blue, Red Meter (–) → Black, Yellow	25 – 45 k $\Omega$
		Meter (+) → Black, Yellow Meter (–) → Blue, Red	20 – 40 k $\Omega$

\*Measured with the Kawasaki Hand Tester (57001-983).

A tester other than the Kawasaki Hand Tester may show slightly different readings.

plug can make the engine run too hot (resulting in engine damage) or too cold (with poor performance, misfiring, and stalling). The standard plug has been selected to match the normal usage of this motorcycle in combined street and highway riding.

Spark Plug

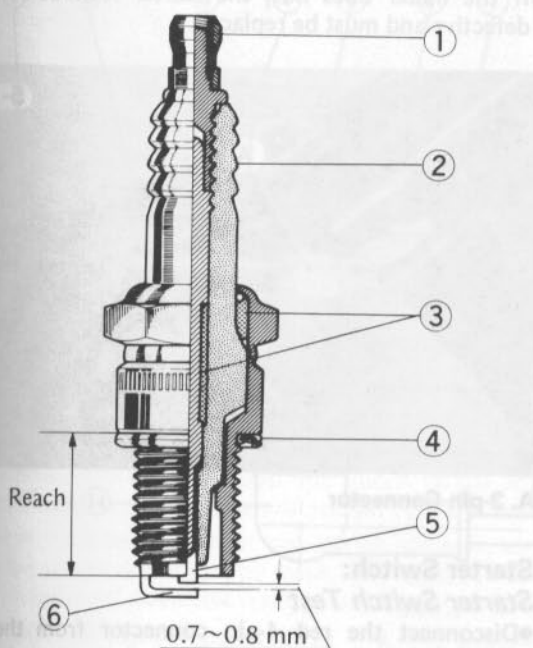

- |              |                     |
|--------------|---------------------|
| 1. Terminal  | 4. Gasket           |
| 2. Insulator | 5. Center Electrode |
| 3. Cement    | 6. Side Electrode   |

Table 5-13 Spark Plug Specifications

Required Plug Threads	Riding Condition	Heat Range	Type
Diameter: 14 mm Pitch: 1.25 mm Reach: 19 mm	Normal	Normal	NGK BR8ES or ND W24ESR-U Ⓢ NGK B8ES or ND W24ES-U

Ⓢ : US model

## ELECTRIC STARTER SYSTEM

**CAUTION** 1. Because of the large amount of current, never keep the starter switch pushed any time that the starter motor will not turn over, or the current may burn out the starter motor windings.

### Starter Relay: Starter Relay Test

• Disconnect the starter motor and battery positive (+) leads from the starter relay, and connect an ohmmeter set to the x 1  $\Omega$  range across the relay terminals.

**CAUTION** 1. The battery positive (+) lead with the red cap is connected directly to the battery positive (+) terminal even when the ignition switch is off, so take care not to short the removed lead to the chassis ground.



**Starter Motor Circuit**

5-25

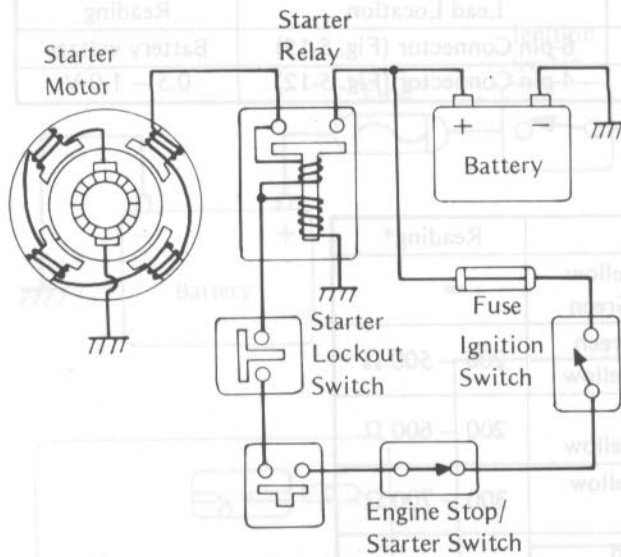

- Turn the ignition switch on.
- Pulling the clutch lever, push the starter switch, and see if the meter reads zero ohms.
- ★ If the relay makes a single clicking sound and the meter reads zero, the relay is good. If the relay clicks but the meter does not read zero, the relay is defective and must be replaced.
- If the relay does not click at all, disconnect the starter relay 2-pin connector, and measure the resistance across the two leads in the male 2-pin connector (relay side).
- ★ There should be a few ohms resistance. If the resistance is infinity (no reading) or zero ohms, the relay is defective.
- However, if there are a few ohms resistance, the relay may be good; check that there is actually voltage to the relay before deciding that the relay is defective.
- To check for the voltage, first turn the meter to the 25V DC range, connect the - meter lead to the black/yellow lead in the female 2-pin connector (main wiring harness side), and connect the + meter lead to the black lead.
- Pulling the clutch lever, push the starter button, and see if the meter reads battery voltage.
- ★ If the meter does not, there is wiring, starter lockout switch, or starter switch trouble. If the meter reads battery voltage but the relay does not click, the relay is defective.

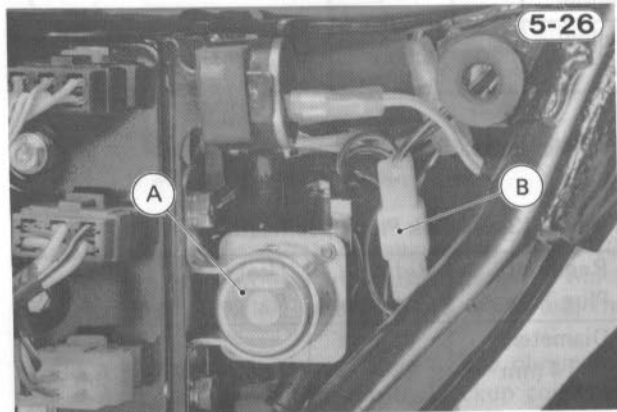

5-26

A. Starter Motor Relay B. 2-pin Connector

**Starter Relay Contact Test**

5-27

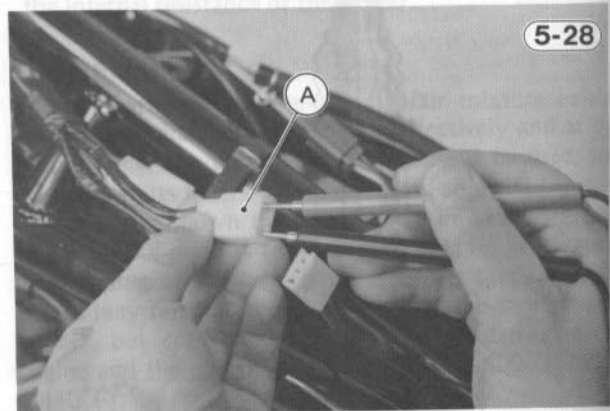
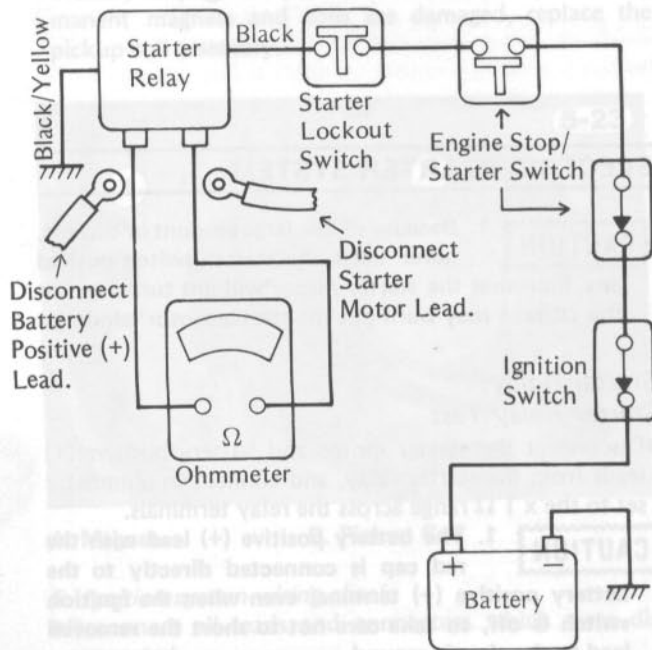

5-28

A. 3-pin Connector

**Starter Switch:**  
*Starter Switch Test*

- Disconnect the red 4-pin connector from the right switch housing.
- Connect an ohmmeter set to the x 1 Ω range across the red and the black leads in the male 4-pin connector (switch side).

- Push the starter switch, and see if the meter reads zero ohms.
- ★ If the meter does not, the starter switch is defective and the entire right switch housing assembly must be replaced.

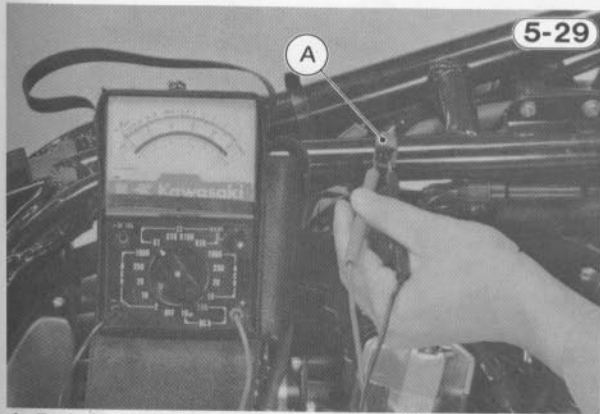

A. Red, 4-pin Connector

**Starter Motor:**

The starter motor is installed in a constant-mesh arrangement to transmit starter motor rotation to the crankshaft. A clutch disengages the starter motor once the engine starts. (See the Starter Clutch Paragraph, Pg. 5-19.)

Fig. 5-31 shows starter motor construction. The field coils ⑤ are wound around four cores ⑦, forming the yoke ⑧, and the armature windings ⑥ are connected to the commutator ⑫ and receive their current through

**Starter Motor Construction**

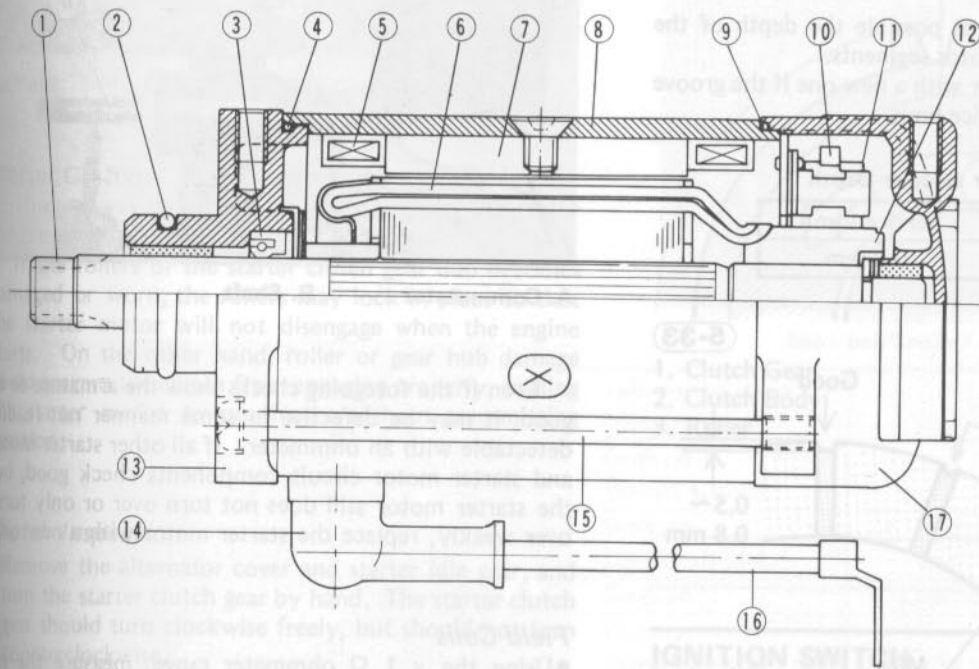

1. Shaft
2. O-ring
3. Grease Seal
4. O-ring
5. Field Coil
6. Armature Coil
7. Core
8. Yoke Assembly
9. O-ring
10. Spring
11. Brush
12. Commutator
13. End Cover
14. Cover
15. Screw
16. Lead
17. End Cover

the brushes ⑪. If the brushes are not making good contact, no starter motor current will flow since the field coils and armature windings are connected in series, and the motor will not turn over. A short or open in a coil or winding may also cause the motor to be inoperative. Particles from brush wear may be another cause of starter motor failure; these particles may get into the bearing at the rear of the motor, causing heat seizure.

**Carbon Brushes**

Worn brushes or weak springs will cause poor brush contact.

- Measure the length of the brushes.
- ★ Replace both if either one is worn down to less than the service limit.

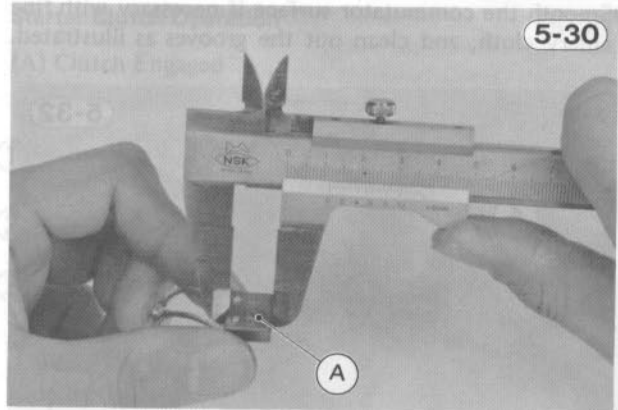

A. Brush

5-31

Table 5-14 Starter Motor Brush Length

Standard	Service Limit
12.0 – 13.0 mm	6 mm

**Brush Spring**

Spring tension should be 560 – 680 grams but a spring can be considered serviceable if it will snap the brush firmly into place.

**Commutator**

A dirty or damaged commutator will result in poor brush contact and cause the brushes to wear down quickly. In addition, particles from brush wear accumulating between commutator segments may cause partial shorts.

- Smooth the commutator surface if necessary with fine emery cloth, and clean out the grooves as illustrated.

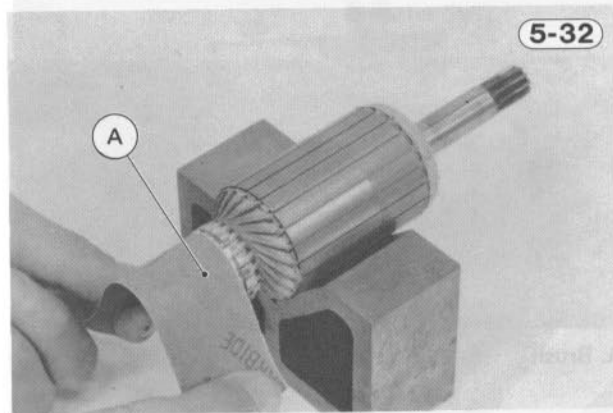

5-32

A. Commutator

- Determine as accurately as possible the depth of the grooves between commutator segments.
- ★Replace the starter motor with a new one if the groove depth is less than the service limit.

Table 5-15 Commutator Groove Depth

Standard	Service Limit
0.5 – 0.8 mm	0.2 mm

**Commutator**

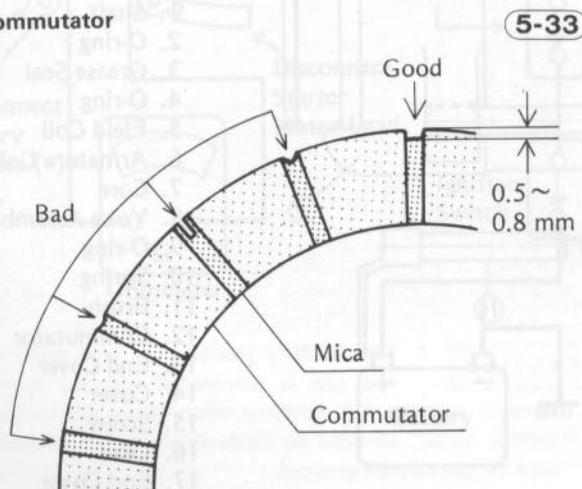

- Using the x 1 Ω ohmmeter range, measure the resistance between any two commutator segments.
- ★If there is a high resistance or no reading (∞) between any two segments, a winding is open and the starter motor must be replaced.

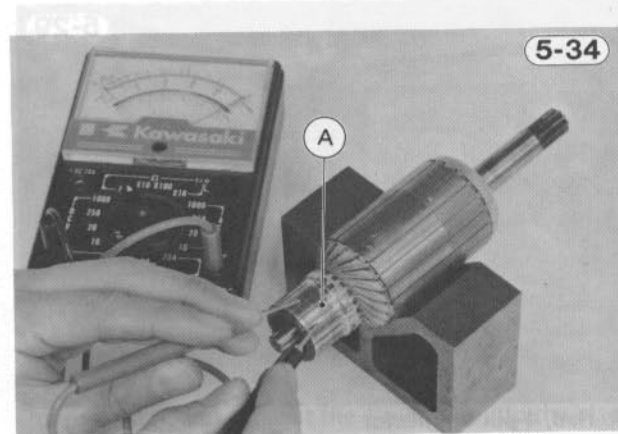

A. Segment

- Using the highest ohmmeter range, measure the resistance between the commutator and the shaft.
- ★If there is any reading at all, the armature has a short and the starter motor must be replaced.

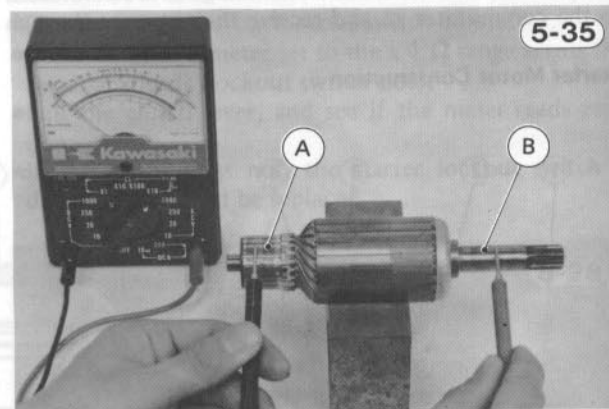

A. Commutator

B. Shaft

Even if the foregoing checks show the armature to be good, it may be defective in some manner not readily detectable with an ohmmeter. If all other starter motor and starter motor circuit components check good, but the starter motor still does not turn over or only turns over weakly, replace the starter motor with a new one.

**Field Coils**

- Using the x 1 Ω ohmmeter range, measure the resistance between the + side carbon brush and the starter motor terminal.
- ★If there is not close to zero ohms, the field coils have an open and the starter motor must be replaced.

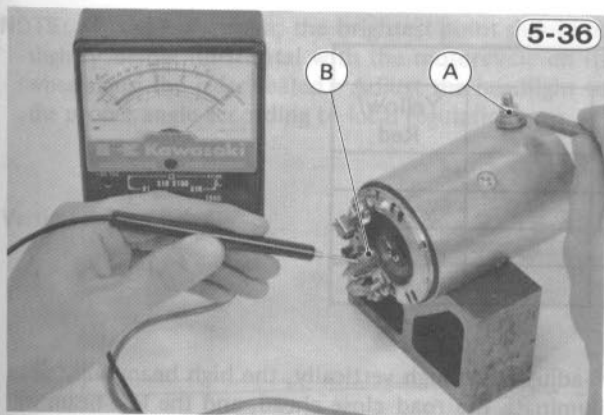

A. Starter Motor Terminal B. + Side Carbon Brush

- Using the highest ohmmeter range, measure the resistance between the + side carbon brush and the yoke (housing).
- \*If there is any meter reading, the coils are shorted to ground and the starter motor must be replaced.

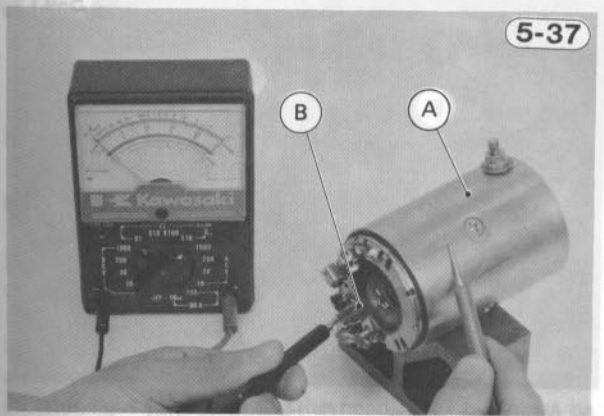

A. Yoke B. + Side Carbon Brush

**Starter Clutch:**

This motorcycle uses a roller-type, one-way clutch for the starter clutch.

If the rollers or the starter clutch gear hub becomes damaged or worn, the rollers may lock in place so that the starter motor will not disengage when the engine starts. On the other hand, roller or gear hub damage could prevent the clutch from engaging properly, causing the starter motor to run freely without transmitting rotation.

**Clutch Inspection**

- Remove the alternator cover and starter idle gear, and turn the starter clutch gear by hand. The starter clutch gear should turn clockwise freely, but should not turn counterclockwise.
- \*If the clutch does not operate as it should or if it makes noise, disassemble the starter clutch, examine each part visually, and replace any worn or damaged parts.

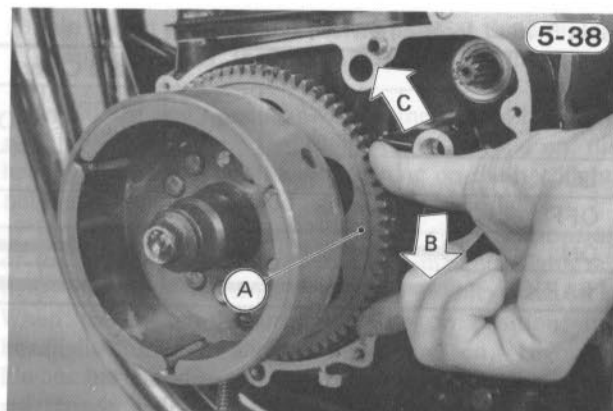

A. Starter Clutch Gear B. Turns Freely. C. Locked.

**Starter Clutch Operation**

(A) Clutch Engaged

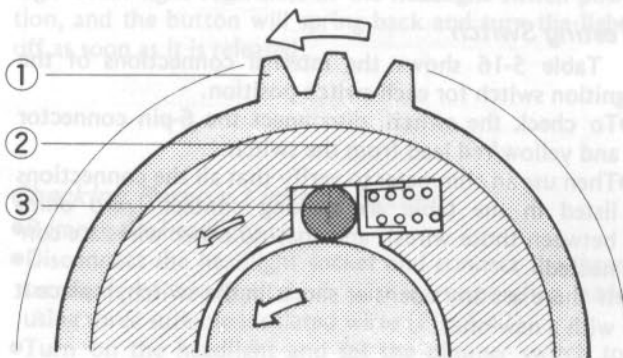

(B) Clutch Disengaged

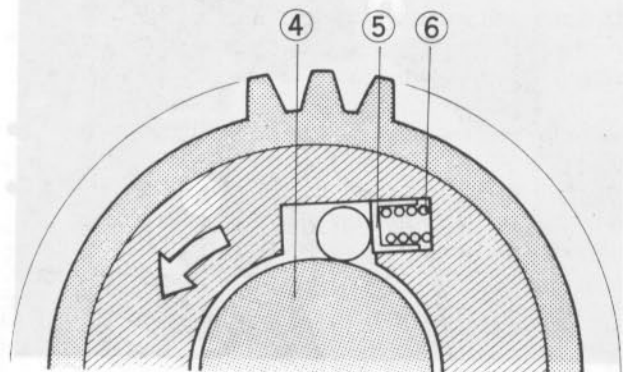

- |                |               |
|----------------|---------------|
| 1. Clutch Gear | 4. Crankshaft |
| 2. Clutch Body | 5. Spring Cap |
| 3. Roller      | 6. Spring     |

**IGNITION SWITCH**

The ignition switch has four positions: lock, off, on, and park. In the lock and off positions all circuits are turned off and the key can be removed from the switch.

Table 5-16 Ignition Switch Connections

	Lead Color						
	White	White/ Black	Red	Orange/ White	Orange	Brown	Yellow/ Red
LOCK							
OFF							
ON	●————●			●————●		●————●	
PARK	●————●			●————●			

In the on position the motorcycle can be started and all electrical equipment can be used. The key cannot be removed from the switch when it is in the on position. In the park position the tail light is on, but all other circuits are cut off and the key can be removed from the switch. This provides added visibility when the motorcycle is parked.

### Testing Switch

Table 5-16 shows the internal connections of the ignition switch for each switch position.

- To check the switch, disconnect the 6-pin connector and yellow/red lead from the switch.
- Then use an ohmmeter to verify that all the connections listed in the table are making contact (zero ohms between those wires), and that no other wires are connected.
- ★If there are any opens or shorts in the switch, replace it with a new one.

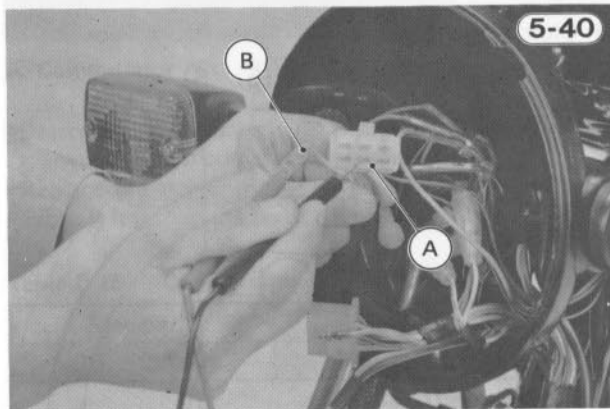

A. 6-pin Connector B. Yellow/Red Lead

If adjusted to high vertically, the high beam will fail to illuminate the road close ahead, and the low beam will dazzle oncoming drivers. In most areas it is illegal to ride with improperly adjusted headlights.

### Horizontal Adjustment

- Turn the adjusting screw on the headlight rim in or out until the beam points straight ahead. Turning the adjusting screw clockwise makes the headlight beam point to the left.

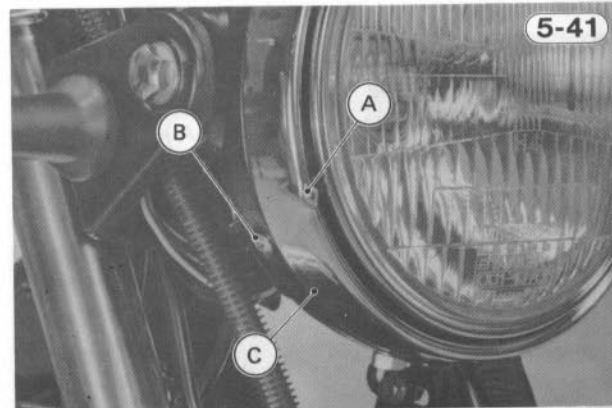

A. Adjusting Screw C. Headlight Unit  
B. Mounting Screws

### Vertical Adjustment

- Remove the mounting screws, and drop out the headlight unit.
- Loosen the lower headlight bolt.
- Loosen the headlight housing mounting nuts, and adjust the headlight vertically.

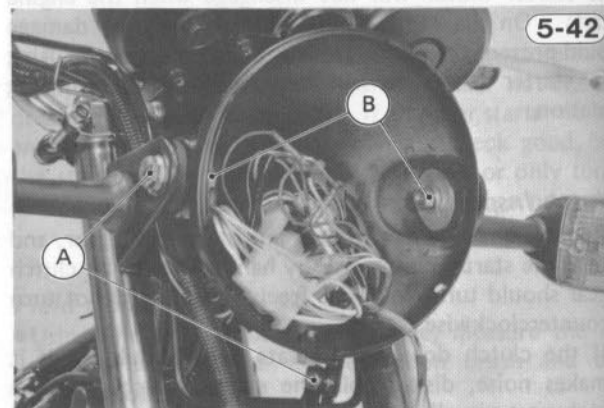

A. Bolt B. Mounting Nuts

## HEADLIGHT

### Headlight Beam:

The headlight beam is adjustable both horizontally and vertically. If not properly adjusted horizontally, the beam will point to one side rather than straight ahead. If adjusted too low vertically, neither low nor high beam will illuminate the road far enough ahead.

**NOTE:** 1. On high beam, the brightest point should be slightly below horizontal with the motorcycle on its wheels and the rider seated. Adjust the headlight to the proper angle according to local regulations.

### Vertical Adjustment

5-43

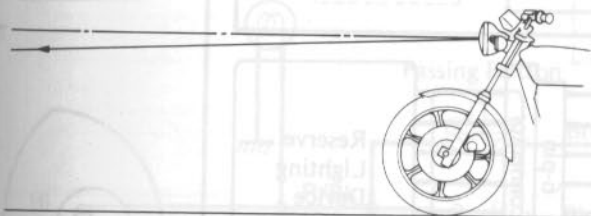

- Tighten the headlight housing mounting nuts.
- Tighten the lower headlight bolt.
- Install the headlight unit, and tighten the mounting screws.

### Headlight Circuit and Reserve Lighting System:

Fig. 5-44 through 5-46 are US, Canadian and European model wiring diagrams of the headlight circuit.

The US and Canadian models of the KZ1000-K and J contain a reserve lighting system in the headlight circuit.

If either the high or low beam burns out, the reserve lighting system switches over to the remaining filament automatically, and lights the white headlight failure indicator light to show that the headlight bulb must be replaced. If the high beam filament burns out, the low beam is automatically turned on; if low beam burns out, the high beam is turned on but more dimly than normal.

**NOTE:** 1. Current is always flowing slightly in the headlight failure indicator light when the ignition switch

is in the on position. So you may notice the indicator glimmers unless the headlight filaments burn out.

In the US and Canadian model, there is no headlight switch, and when the ignition switch is turned on, the headlight circuit is completed, turning on the headlight, tail lights, running position lights, and meter lights.

In the European model, the center city light position of the headlight switch turns on the small city light, tail lights and meter lights for driving in the city after dark. When the switch is turned to the on position, the headlight comes on and city light stays on. High and low beam can be selected only when the headlight switch is in the on position.

There is also a passing and horn button (European model). This button is spring loaded and when the button is pushed to pass, the high beam light (but not the tail light) comes on as a passing signal to the driver of the vehicle ahead. The passing button will light the high beam light regardless of the headlight switch position, and the button will spring back and turn the light off as soon as it is released.

### Checking Reserve Lighting System

- Remove the headlight unit.
- Disconnect the headlight socket and connect the three terminals of headlight bulb with corresponding leads using three suitable insulated wires (Fig. 5-47).
- Turn on the headlight and set the dimmer switch to the low beam position.
- Disconnect the wire which is connected to the red/yellow lead to simulate a bad low beam filament. At this time the high beam should go on more dimly than normal, and the white headlight failure indicator should come on.
- Connect the red/yellow lead, and set the dimmer switch to the high beam position.
- Disconnect the wire which is connected to the red/black lead to simulate high beam failure. At this time the low beam should come on and the white indicator light should light.

Table 5-17 Reserve Lighting System Operation

Headlight	Dimmer Switch Position	Headlight Failure Indicator Light	Reserve Lighting
Both high and low beam filaments are normal	HI	Goes on (hardly visible)	_____
	LO	Goes on (hardly visible)	_____
High beam filament burned out	HI	Goes on	Low beam comes on.
	LO	Goes on (hardly visible)	_____
Low beam filament burned out	HI	Goes on (hardly visible)	_____
	LO	Goes on	High beam comes on dimly.

Headlight Circuit (US, Canadian model KZ1000-J and K)

5-44

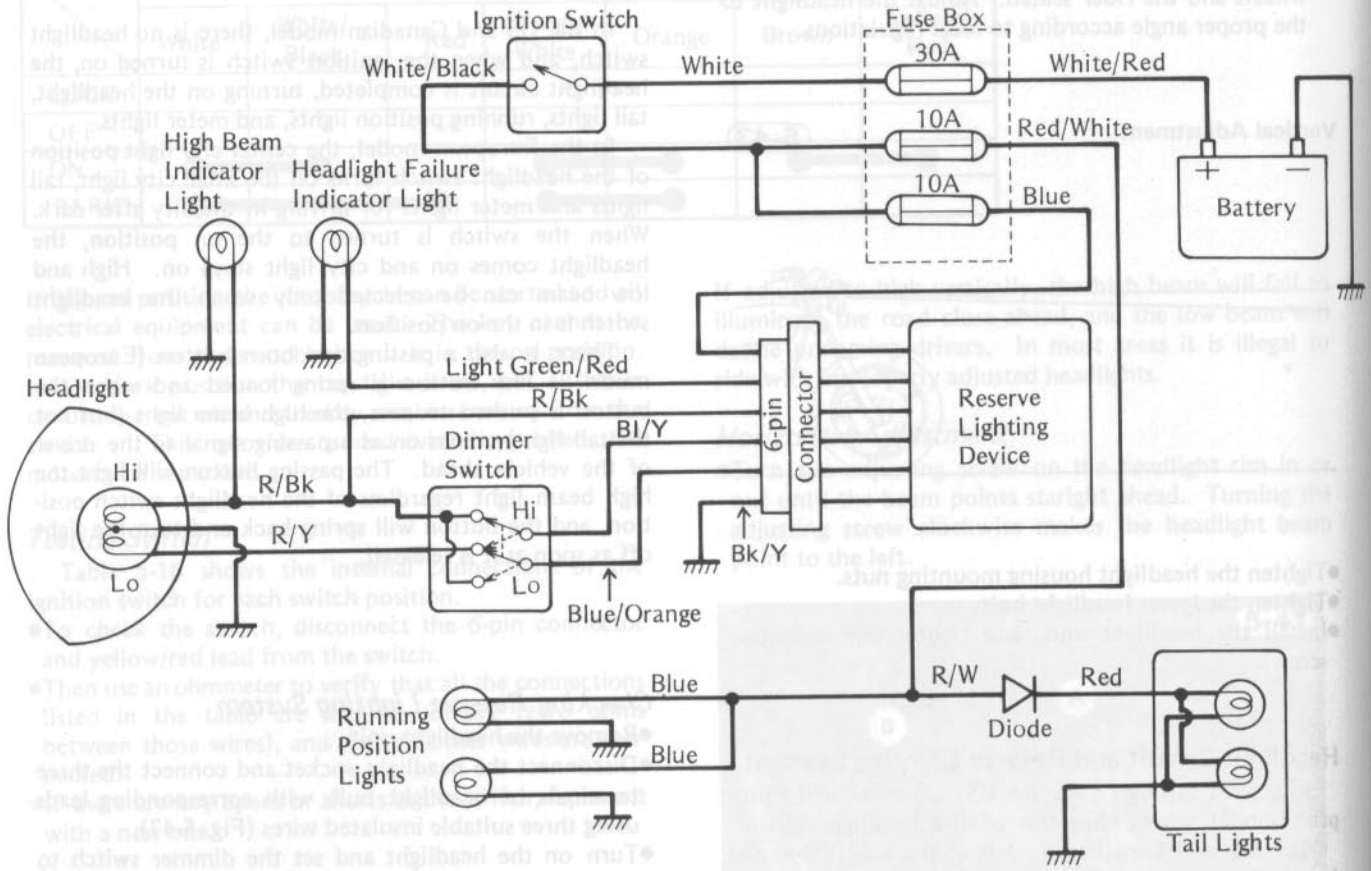

Headlight Circuit (US, Canadian model KZ1000-M)

5-45

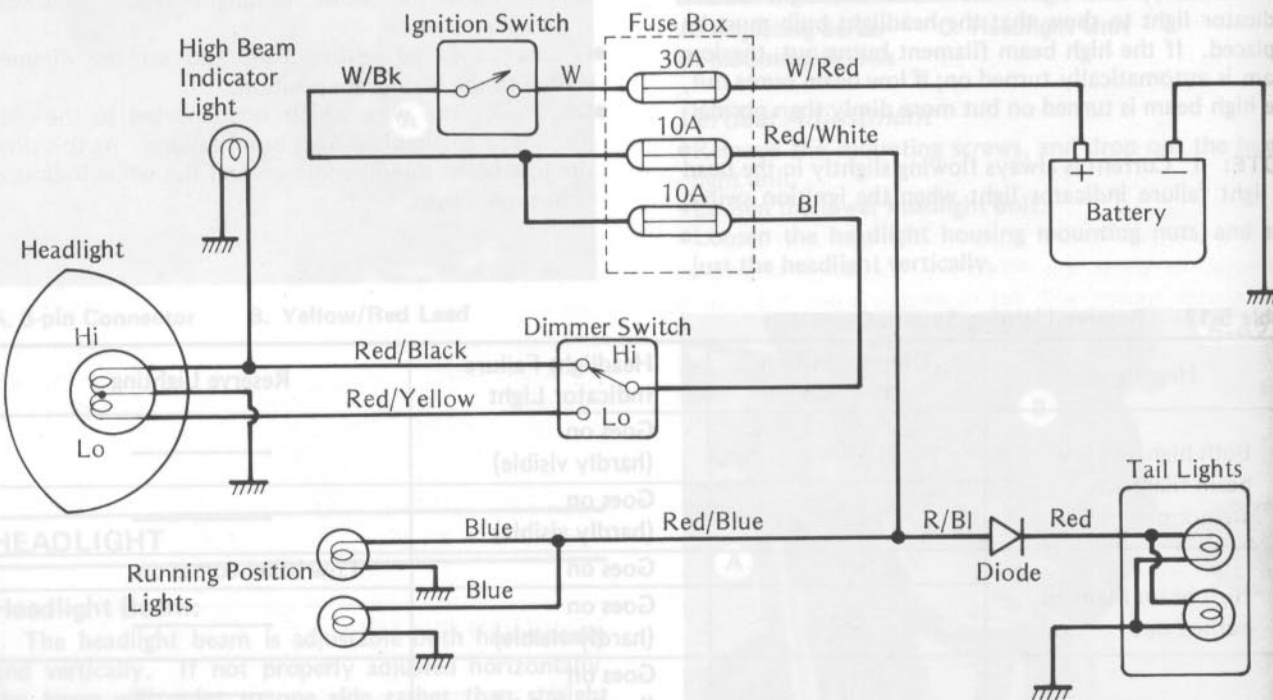

Headlight Circuit (European model Z1000-J and K)

5-46

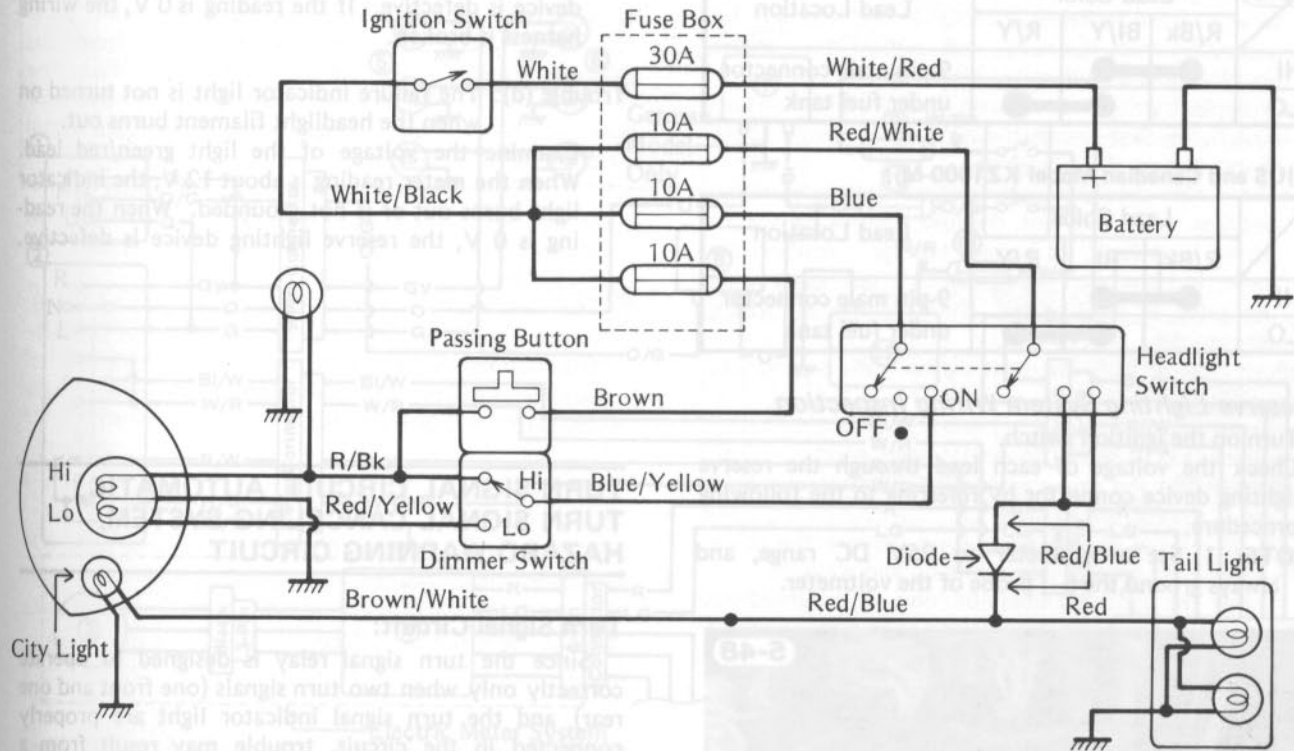

Checking Reserve Lighting System

5-47

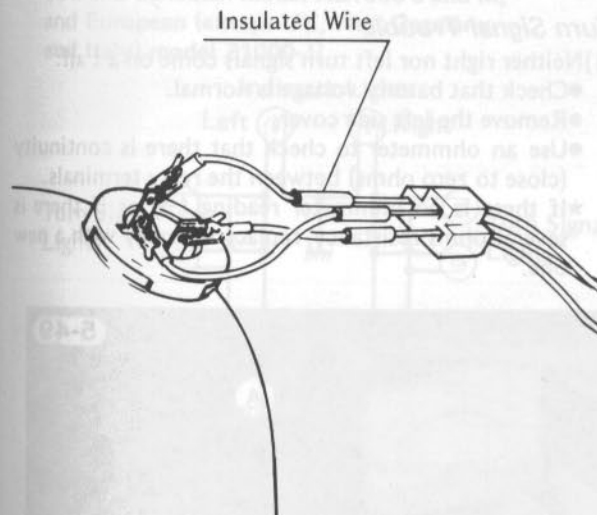

Headlight, Dimmer Switch Inspection

Tables 5-18 through 5-19 show the connections in the headlight switch, and the connections in the dimmer switch for both high and low beam.

- Disconnect the connectors to the headlight switch or the leads to the dimmer switch.

- Use an ohmmeter to see that only the connections shown in the tables have continuity (zero ohms).
- ★ If the switch has open or a short, it can be disassembled for repair. The contact surfaces may be cleaned, but no internal parts are available for replacement. If any parts are not repairable, the switch must be replaced as a unit.

Table 5-18 Headlight Switch Connections (European model Z1000-J and K)

	Lead Color				Lead Location
	R/W	R/BI	BI	BI/Y	
OFF					Green, 9-pin, male connector under fuel tank
•	●—●				
ON	●—●		●—●		

Table 5-19 Dimmer Switch Connections (1) US and Canadian Model KZ1000-J and K

	Lead Color				Lead Location
	R/Bk	BI/Y	R/Y	BI/O	
HI	●—●		●—●		9-pin male and 3-pin male connectors under fuel tank
LO	●—●	●—●	●—●		



**(2) European Model Z1000-J and K**

	Lead Color			Lead Location
	R/Bk	BI/Y	R/Y	
HI	●	●		9-pin male connector under fuel tank
LO		●	●	

**(3) US and Canadian Model KZ1000-M**

	Lead Color			Lead Location
	R/Bk	BI	R/Y	
HI	●	●		9-pin male connector under fuel tank
LO		●	●	

**Reserve Lighting System Wiring Inspection**

- Turn on the ignition switch.
- Check the voltage of each lead through the reserve lighting device connector by referring to the following procedure.

**NOTE:** 1. Set a voltmeter to 25V DC range, and always ground the (–) probe of the voltmeter.

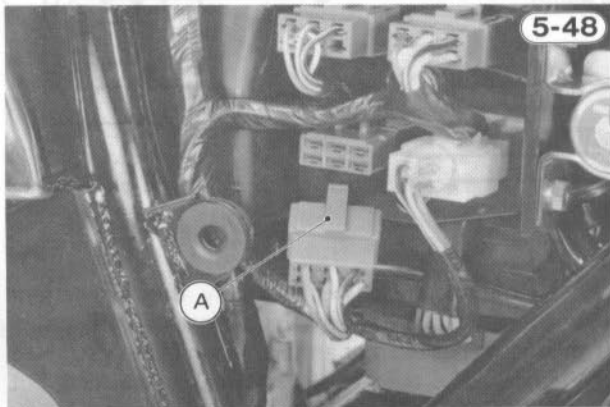

**A. Brown, 6-pin, Reserve Lighting Device Connector**

Trouble (a): When one filament is burned out, the other is not turned on.

- Examine the voltage of blue/orange lead by applying the (+) probe of voltmeter to the lead. When the meter reading is about 12 V, both filaments of the headlight are burned out or the black/yellow lead is broken. When the meter reading is less than about 12 V, advance to the next step.
- Examine the voltage of the blue lead. If the meter reading is about 12 V, the reserve lighting device is defective. When the reading is 0 V, the ignition switch or wiring harness is broken.

Trouble (b): Both filaments for upper beam and lower beam are turned on at the same time.

- Examine the voltage of the blue/orange lead. When the meter reading is about 12 V, the reserve lighting device is defective. When the reading is 0 V, the dimmer switch is defective.

Trouble (c): The high beam is not dimmed when the low beam burns out and the high one is turned on automatically.

- Examine the voltage of the red/black lead. If the meter reading is about 12 V, the reserve lighting device is defective. If the reading is 0 V, the wiring harness is broken.

Trouble (d): The failure indicator light is not turned on when the headlight filament burns out.

- Examine the voltage of the light green/red lead. When the meter reading is about 12 V, the indicator light burns out or is not grounded. When the reading is 0 V, the reserve lighting device is defective.

## TURN SIGNAL CIRCUIT, AUTOMATIC TURN SIGNAL CANCELING SYSTEM, HAZARD WARNING CIRCUIT

**Turn Signal Circuit:**

Since the turn signal relay is designed to operate correctly only when two turn signals (one front and one rear) and the turn signal indicator light are properly connected in the circuit, trouble may result from a burned out bulb, a bulb of incorrect wattage, loose wiring, as well as from a defect in the relay itself. In general, if the trouble with the circuit is common to both right and left turn signals, it is probably caused by a defective turn signal relay, although it may be due to a bad switch, wiring, or battery. If the trouble is with only one side – either right or left – then the relay is not at fault since the same relay is used for both sides.

**Turn Signal Trouble**

(1) Neither right nor left turn signals come on at all:

- Check that battery voltage is normal.
- Remove the left side cover.
- Use an ohmmeter to check that there is continuity (close to zero ohms) between the relay terminals.
- ★ If there is no ohmmeter reading ( $\infty$ ) or if there is several ohms resistance, replace the relay with a new one.

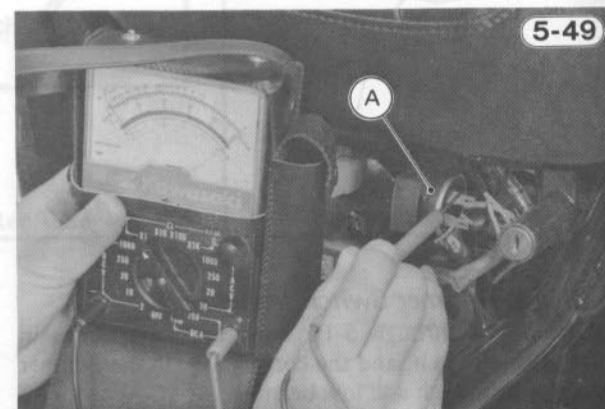

**A. Turn Signal Relay**

**Turn Signal Circuit, Automatic Canceling System, and Hazard Warning Circuit (KZ/Z1000-K)**

5-50

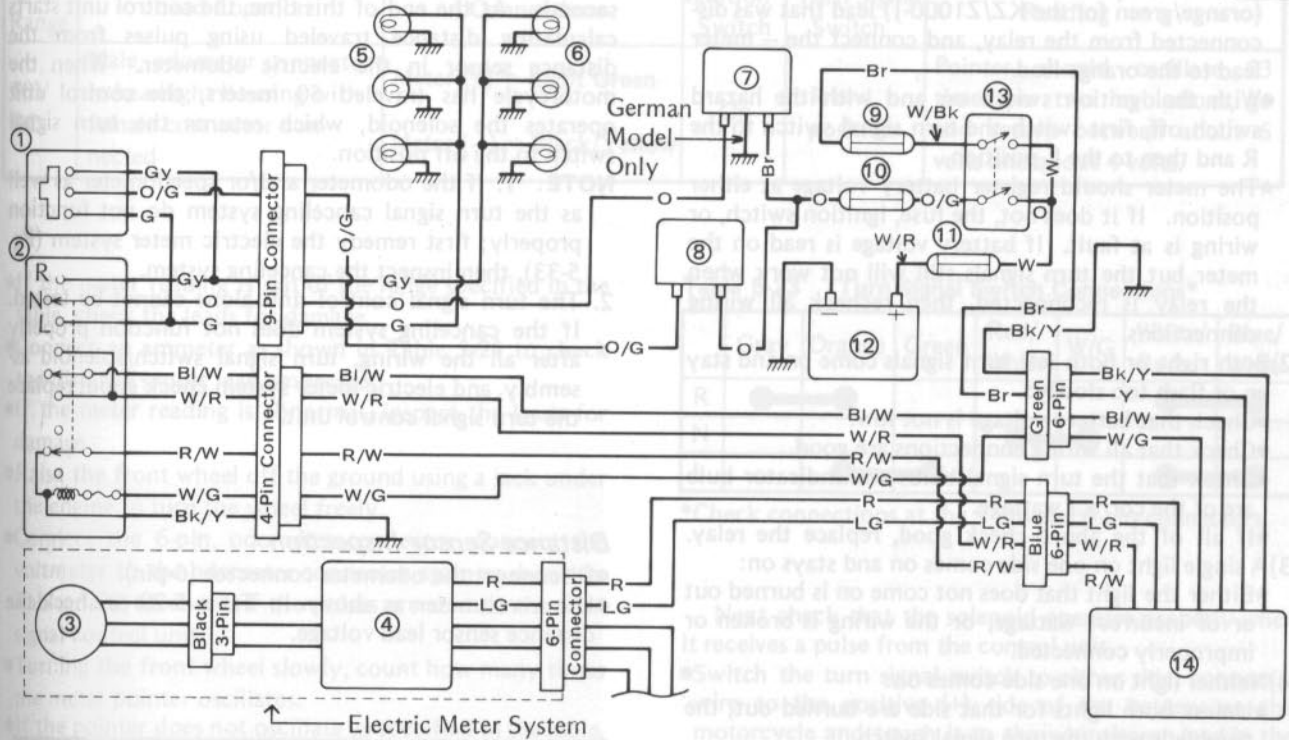

- 1. Hazard Switch
- 2. Turn Signal Switch
- 3. Speed Sensor
- 4. Odometer
- 5. Left Turn Signals and Indicator
- 6. Right Turn Signals and Indicator
- 7. Turn Signal Relay
- 8. Hazard Relay
- 9. 10A Fuse
- 10. 10A Fuse
- 11. 30A Fuse
- 12. Battery
- 13. Ignition Switch
- 14. Turn Signal Control Unit

**Turn Signal and Hazard Warning Circuit [US and Canadian model KZ1000-J and M, and European (except UK, West Germany, and Italy) model Z1000-J]**

5-51

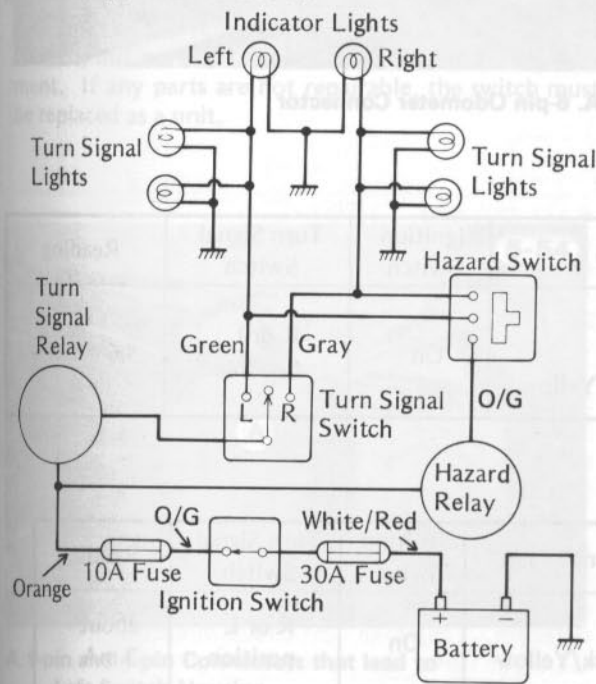

**Turn Signal Circuit (West German, UK, and Italian model Z1000-J)**

5-52

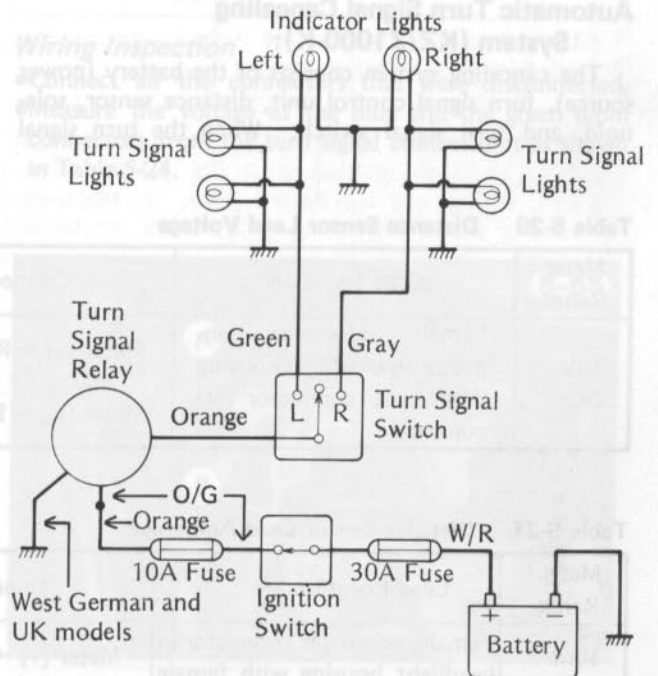

- If the relay checks good, turn the meter to the 25V DC range, connect the + meter lead to the brown (orange/green for the KZ/Z1000-J) lead that was disconnected from the relay, and connect the - meter lead to the orange lead.
  - With the ignition switch on and with the hazard switch off, first switch the turn signal switch to the R and then to the L position.
  - ★ The meter should register battery voltage at either position. If it does not, the fuse, ignition switch, or wiring is at fault. If battery voltage is read on the meter but the turn signals still will not work when the relay is reconnected, then recheck all wiring connections.
- (2) Both right or both left turn signals come on and stay on or flash too slowly:
- Check that battery voltage is not low.
  - Check that all wiring connections are good.
  - Check that the turn signal bulbs and indicator bulb are of the correct wattage.
  - ★ If all of the above check good, replace the relay.
- (3) A single light on one side comes on and stays on:
- ★ Either the light that does not come on is burned out or of incorrect wattage, or the wiring is broken or improperly connected.
- (4) Neither light on one side comes on:
- ★ Unless both lights for that side are burned out, the trouble is with the turn signal switch.
- (5) Flashing rate is too fast:
- ★ If this occurs on both the right and left sides, check that the battery is not being overcharged (indicating a defective regulator/rectifier). If the alternator and the battery voltage are normal, replace the turn signal relay.
  - ★ If this occurs on only one side, one or both of the turn signal bulbs are of too high a wattage.

switch is pushed to the left or right, the turn signals start flashing and the control unit starts counting off 4 seconds. At the end of this time, the control unit starts calculating distance traveled using pulses from the distance sensor in the electric odometer. When the motorcycle has traveled 50 meters, the control unit operates the solenoid, which returns the turn signal switch to the off position.

- NOTE:**
1. If the odometer and/or speedometer as well as the turn signal canceling system do not function properly; first remedy the electric meter system (Pg. 5-33), then inspect the canceling system.
  2. The turn signal control unit alone cannot be tested. If the canceling system does not function properly after all the wiring, turn signal switch/solenoid assembly, and electric meter system check good; replace the turn signal control unit.

**Distance Sensor Inspection**

- Disconnect the odometer connector (6-pin).
- Use a voltmeter as shown in Table 5-20 to check the distance sensor lead voltage.

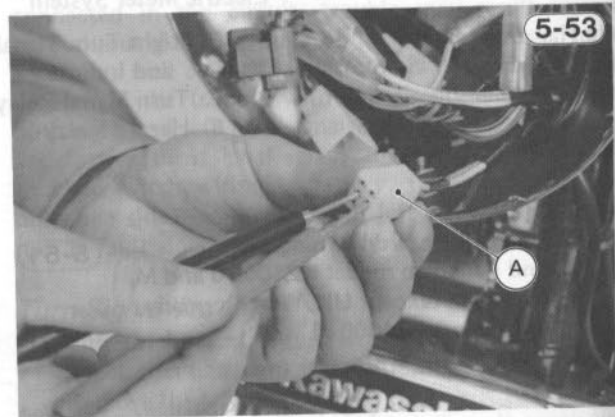

**A. 6-pin Odometer Connector**

**Automatic Turn Signal Canceling System (KZ/Z1000-K):**

The canceling system consists of the battery (power source), turn signal control unit, distance sensor, solenoid, and turn signal switch. When the turn signal

**Table 5-20 Distance Sensor Lead Voltage**

Meter Range	Lead Location	Connections	Ignition Switch	Turn Signal Switch	Reading
10V DC	Female, odometer connector in headlight housing with male connector disconnected	Meter (+) → Red Meter (-) → Black/Yellow	On	R or L position	5.6 – 8.4 V

**Table 5-21 Distance Sensor Lead Amperage**

Meter Range	Lead Location	Connections	Ignition Switch	Turn Signal Switch	Reading
10mA DC	Female, odometer connector in headlight housing with female connector disconnected	Meter (+) → Red Meter (-) → Black/Yellow	On	R or L position	about 3 mA

Table 5-22 Distance Sensor Pulse

Meter Range	Lead Location	Connections	Ignition Switch	Turn Signal Switch	Reading
10V DC	Male, odometer connector in headlight housing with female connector connected	Meter (+) → Light Green Meter (-) → Black/Yellow	On	R or L position	Pointer should oscillate 23 times per two revolutions, go and return between about 6 volts and about 4 volts.

- \*If the meter reading is out of the range specified in the table, check the leads for damage.
- Connect an ammeter as shown in Table 5-21 to check the distance sensor lead amperage.
- \*If the meter reading is abnormal, inspect the leads for damage.
- Raise the front wheel off the ground using a jack under the engine to turn the wheel freely.
- Connect the 6-pin, odometer connector, connect the voltmeter to the odometer connector again as shown in Table 5-22 to check if the pulses are sent to the turn signal control unit.
- Turning the front wheel slowly, count how many times the meter pointer oscillates.
- \*If the pointer does not oscillate as specified in the table, the distance sensor in the electric odometer is damaged. Replace the electric odometer.

### Turn Signal Switch Inspection

- Unplug the 9-pin and 4-pin connectors that leads to the left switch housing.
- Check the turn signal switch connections according to Table 5-23.
- \*If the switch has an open circuit or a short, it can be disassembled for repair. The contact surfaces may be cleaned, but no internal parts are available for replacement. If any parts are not repairable, the switch must be replaced as a unit.

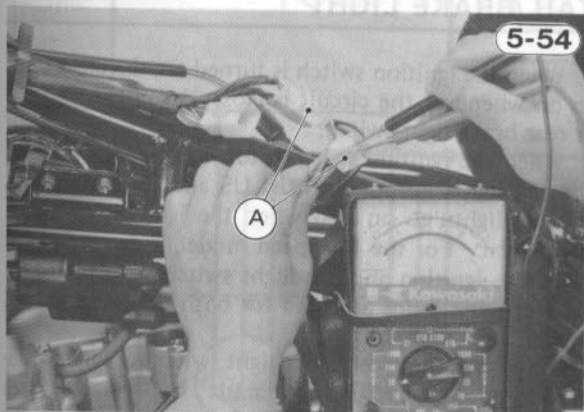

A. 9-pin and 4-pin Connectors that lead to Left Switch Housing

Table 5-23 Turn Signal Switch Connections\*

	Gray	Orange	Green	Red/White	W/G	White/Red	Blue/White
R	●	●				●	●
N				●	●		
L		●	●			●	●

\*Check connections at the 9-pin and 4-pin connectors.

Next check that the solenoid operates properly when it receives a pulse from the control unit.

- Switch the turn signal switch to either side, connect a wire to the positive (+) side of the battery on the motorcycle and touch it to the white/green lead in the male, 9-pin connector that leads to the left switch housing momentarily.
- \*At this time the solenoid should return the turn signal switch to the off position. If it does not do this for both right and left positions, replace the switch assembly.

**CAUTION** 1. Do not connect the battery lead to the white/green lead for more than a few seconds, as it could burn out the solenoid.

### Wiring Inspection

- Connect all the connectors that were disconnected.
- Measure the voltage at the blue and the green 6-pin connectors from the turn signal control unit as shown in Table 5-24.

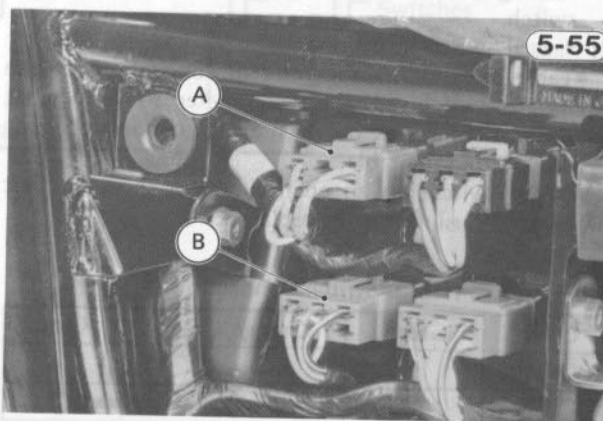

A. Blue, 6-pin Connector  
B. Green, 6-pin Connector

Table 5-24 Wiring Inspection

Meter Range	Connections*	Ignition Switch	Turn Signal Switch Position	Reading
25V DC	Meter (+) → Brown, Blue/White	on	Any (R, L, Neu.)	Battery voltage
		off	Any	0V
	Meter (+) → White/Red	on	R or L	Battery voltage
		off	Neutral	0V

\*Connect the meter negative (-) lead to ground.

★If any one of the meter readings shows an improper value, check the wiring and connections of the turn signal switch, distance sensor, and turn signal control unit. Replace the turn signal control unit if all of them turn out good.

**NOTE:** 1. The turn signal control unit is located beneath the battery case (Fig. 5-56).

**Hazard Warning Circuit:**

*Testing the Hazard Warning Circuit*

Before testing the hazard warning circuit, check the turn signal operation.

(1) Wiring Inspection

- Unplug the 9-pin connector that leads to the left switch housing, and connect the voltmeter as shown in Table 5-25 to measure the lead voltage.

Table 5-25 Hazard Warning Circuit Wiring Inspection

Meter	Connections*	Ignition Switch	Reading
25V DC	Meter (+) → Orange/Green	On or Park Position	Battery Voltage
	Meter (-) → Ground	Off or Lock	0V

\* Check the connections at the 9-pin connectors that leads to the left switch housing.

★If any one of the meter readings shows an improper value, check the ignition switch (Pg. 5-19), connectors, wiring, and the hazard relay. If the meter reading shows the wiring good, check the hazard switch.

(2) Hazard Switch Inspection

- Table 5-26 shows the internal connections of the hazard switch. Use an ohmmeter to verify that there is continuity between all the connections that are listed in the table.
- ★If the switch has an open circuit or short, the left switch housing must be replaced.

Table 5-26 Hazard Switch Connections\*

Color	Green	Orange/Green	Gray
Off			
On	●—————●—————●		

\* Check the switch connections at the 9-pin connector that leads to the left switch housing.

(3) Hazard Relay Inspection

- Disconnect the hazard relay leads, and use an ohmmeter to check there is continuity (close to zero ohms) between the relay terminals.

★If there is no ohmmeter reading ( $\infty$ ), or if there is several ohms resistance; replace the relay with a new one.

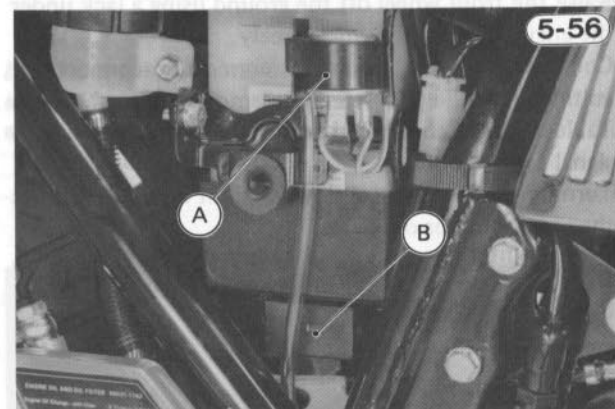

A. Hazard Relay  
B. Turn Signal Control Unit (KZ/Z1000-K)

**TAIL/BRAKE LIGHT**

When the ignition switch is turned on, the brake lights go on whenever the circuit is closed by either the front or rear brake light switch.

When the ignition switch is turned to PARK position, the tail lights go on. For the US and Canadian model, the tail lights go on also when the ignition switch are turned on. For the European model, they go on when both the ignition and headlight switches are turned on.

The same bulbs are used for both the brake and tail lights.

The front and rear brake light switches cannot be disassembled for repair and must be replaced when defective. Tail/brake light circuit inspection involves the tail/brake lights, the front brake light switch, rear brake light switch, and wiring.

Tail/Brake Light Circuit (US, Canadian Models)

5-57

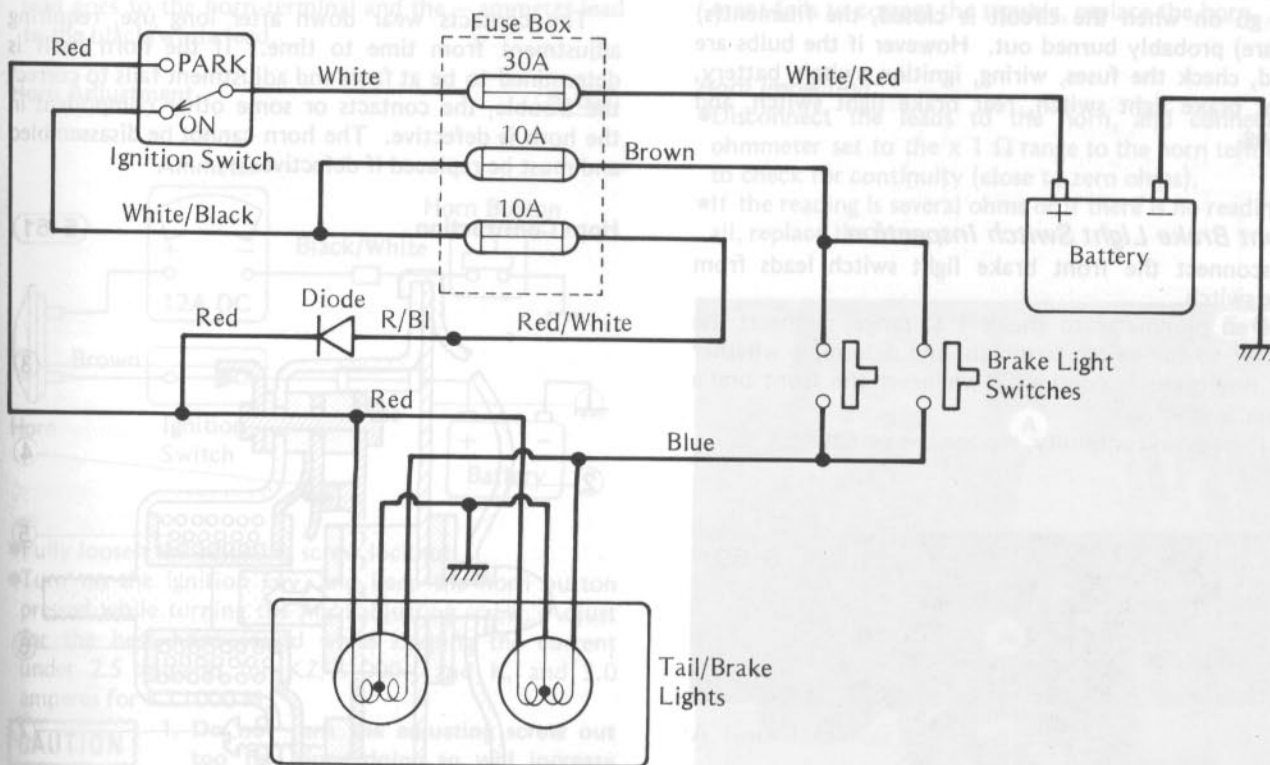

Tail/Brake Light Circuit (European Model)

5-58

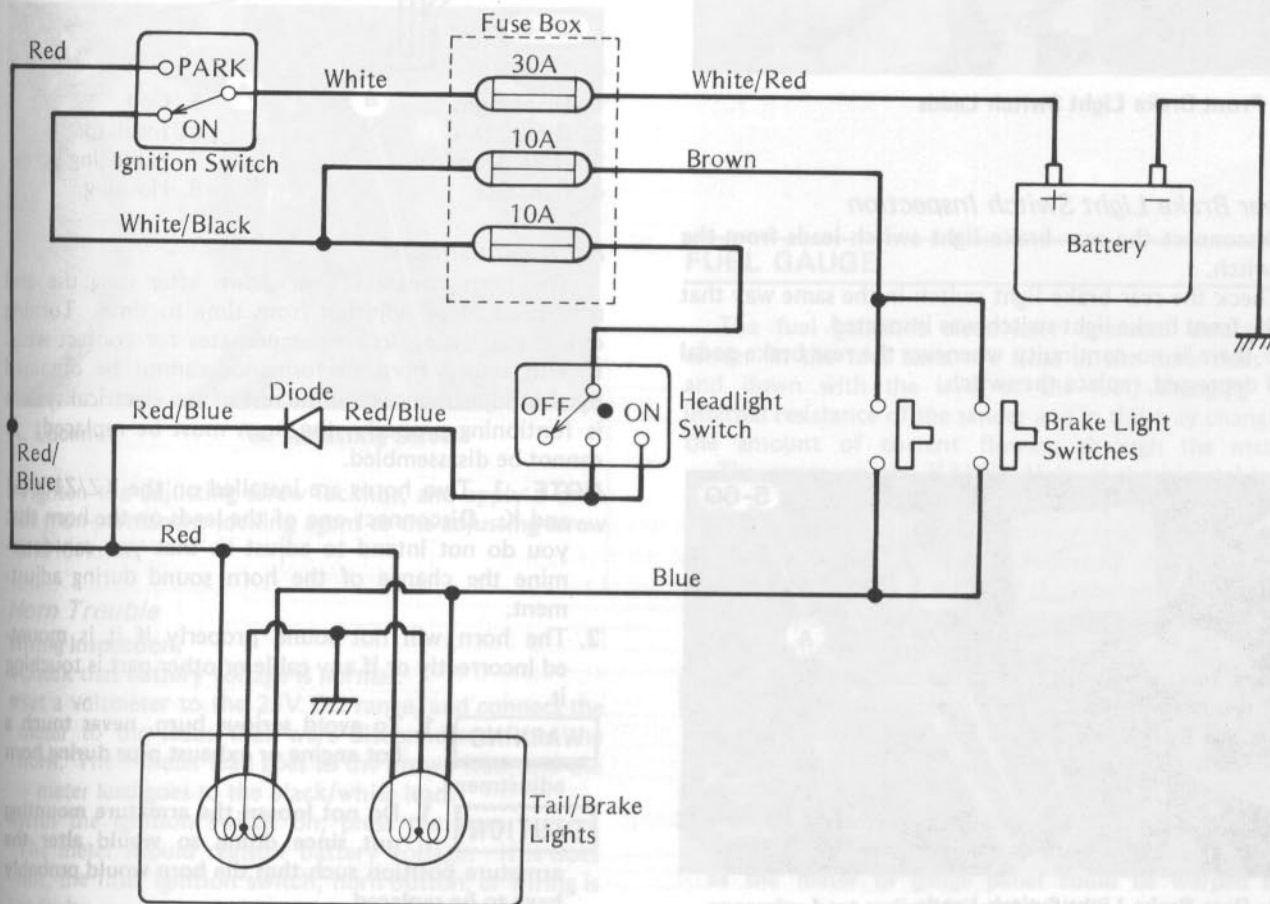

### Tail/Brake Light Trouble:

If one or both of the two tail/brake lights does (do) not go on when the circuit is closed, the filament(s) is (are) probably burned out. However if the bulbs are good, check the fuses, wiring, ignition switch, battery, front brake light switch, rear brake light switch, and wiring.

### Front Brake Light Switch Inspection

- Disconnect the front brake light switch leads from the switch.
- Set an ohmmeter to the  $\times 1 \Omega$  range, connect the meter to the switch terminals, and determine whether or not there is continuity whenever the front brake lever is squeezed.
- ★ If there is no continuity, replace the switch.

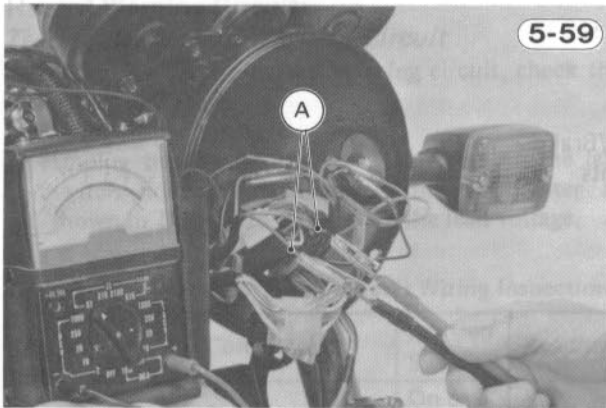

5-59

A. Front Brake Light Switch Leads

### Rear Brake Light Switch Inspection

- Disconnect the rear brake light switch leads from the switch.
- Check the rear brake light switch in the same way that the front brake light switch was inspected.
- ★ If there is no continuity whenever the rear brake pedal is depressed, replace the switch.

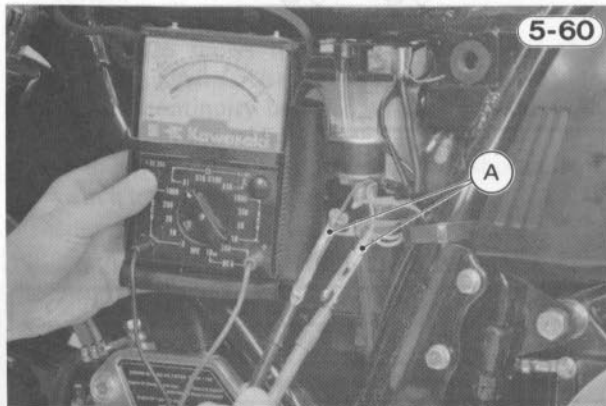

5-60

A. Rear Brake Light Switch Leads

## HORN

The contacts wear down after long use, requiring adjustment from time to time. If the horn itself is determined to be at fault and adjustment fails to correct the trouble, the contacts or some other component in the horn is defective. The horn cannot be disassembled and must be replaced if defective.

### Horn Construction

5-61

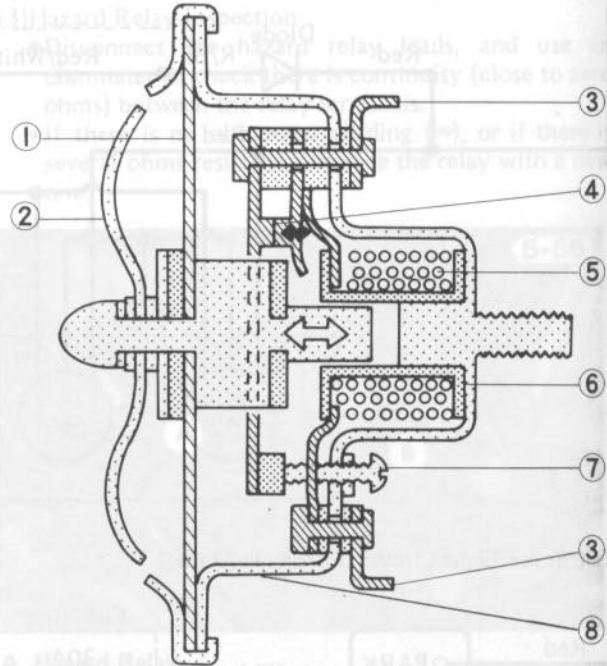

- |                  |                    |
|------------------|--------------------|
| 1. Diaphragm     | 5. Coil            |
| 2. Ringer Disc   | 6. Insulator       |
| 3. Horn Terminal | 7. Adjusting Screw |
| 4. Contacts      | 8. Housing         |

### Horn Adjustment

The horn contacts wear down after long use and may need to be adjusted from time to time. Turning out the adjusting screw compensates for contact wear. If satisfactory horn performance cannot be obtained by this adjustment when the rest of the electrical system is functioning properly, the horn must be replaced. It cannot be disassembled.

**NOTE:** 1. Two horns are installed on the KZ/Z1000-J and K. Disconnect one of the leads on the horn that you do not intend to adjust so that you can determine the change of the horn sound during adjustment.

2. The horn will not sound properly if it is mounted incorrectly or if any cable or other part is touching it.

#### WARNING

1. To avoid serious burn, never touch a hot engine or exhaust pipe during horn adjustment.

#### CAUTION

1. Do not loosen the armature mounting nut since doing so would alter the armature position such that the horn would probably have to be replaced.

- Disconnect the black/white horn lead, and connect an ammeter in series to the horn circuit. The + ammeter lead goes to the horn terminal and the - ammeter lead to the black/white lead.

### Horn Adjustment

5-62

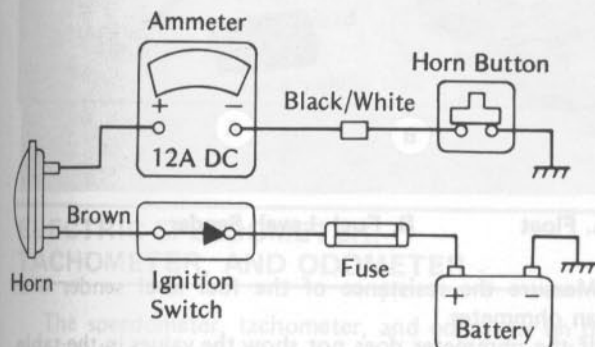

- Fully loosen the adjusting screw locknut.
- Turn on the ignition key, and keep the horn button pressed while turning the horn adjusting screw. Adjust for the best horn sound while keeping the current under 2.5 amperes for KZ/Z1000-J and K, and 3.0 amperes for KZ1000-M.

#### CAUTION

1. Do not turn the adjusting screw out too far, since doing so will increase horn current with the possibility of burning out the horn coil.

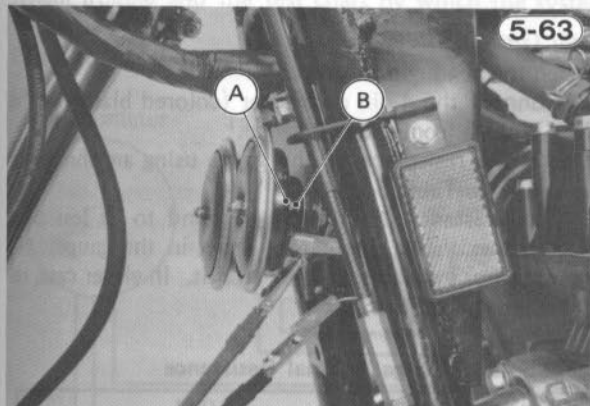

5-63

A. Locknut      B. Adjusting Screw

- Tighten the adjusting screw locknut, and apply a drop of non-permanent locking agent to the adjusting screw and locknut.

### Horn Trouble

#### Wiring inspection:

- Check that battery voltage is normal.
- Set a voltmeter to the 25V DC range, and connect the meter to the leads that were disconnected from the horn. The + meter lead goes to the brown lead, and the - meter lead goes to the black/white lead.
- With the ignition switch on, press the horn button. The meter should register battery voltage. If it does not, the fuse, ignition switch, horn button, or wiring is at fault.

- If the meter does show battery voltage, indicating that the horn trouble lies within the horn itself, and adjustment fails to correct the trouble, replace the horn.

#### Horn inspection:

- Disconnect the leads to the horn, and connect an ohmmeter set to the x 1  $\Omega$  range to the horn terminals to check for continuity (close to zero ohms).
- If the reading is several ohms or if there is no reading at all, replace the horn.



5-64

A. Horn Terminals

## FUEL GAUGE

The fuel gauge is electrically operated through a sender in the fuel tank. A float in the tank rides up and down with the level of the fuel, changing the internal resistance of the sender and in this way changing the amount of current flowing through the meter.

The gauge on the KZ1000-M is of the bimetal type with a 7-volt voltage regulator built into it for over voltage protection, and the pointer returns to the left end when the ignition switch is turned off. The gauge on the KZ/Z1000-J and K is of the moving magnet type, and the pointer remains at the position when the ignition switch is turned off.

#### CAUTION

1. Do not leave the gauge and meter assembly upside down or sideways for longer than three hours, or the damping oil will spill out of the reservoir, and the gauge and meters will malfunction.
2. Do not use an illumination bulb rated for other than 12 volts or wattage specified in the wiring diagram, as the meter or gauge panel could be warped by excessive heat radiated from the bulb.



Fuel Gauge Circuit

5-65

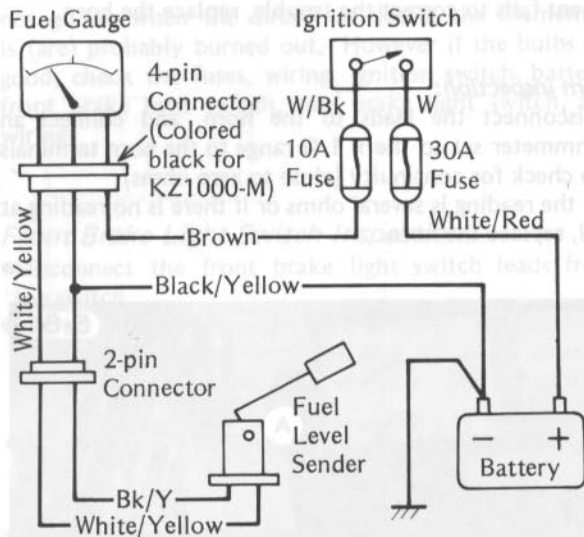

Gauge Circuit Check

- Disconnect the 2-pin connector to the sender underneath the fuel tank, and turn on the ignition switch. At this time the gauge should read "E".
- Short-circuit together the black/yellow and white/yellow leads on the gauge side of the 2-pin connector. At this time the gauge should read "F".

**CAUTION**

1. Do not short-circuit the leads longer than necessary. When the needle swings to the "F" position, stop short-circuiting. Otherwise a good meter could be damaged.

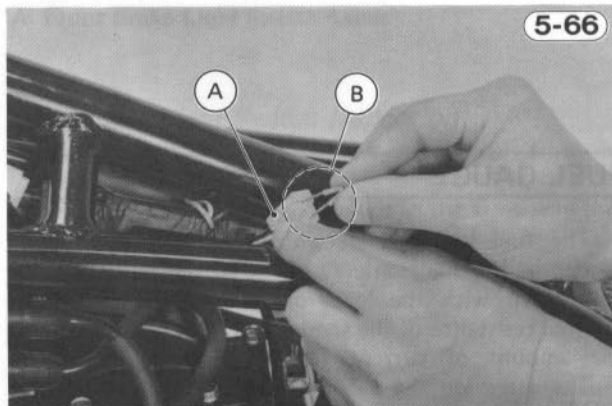

5-66

A. 2-pin Connector  
B. Open or short-circuit leads to check gauge circuit.

★ If the above "E" and "F" readings are correct, the fuel level sender is bad. If these readings are not obtained, the trouble is with the fuel level gauge or wiring.

Fuel Level Sender Inspection

- Drain the fuel tank, and remove the tank.
- Remove the fuel level sender, and check that the float moves up and down smoothly without binding. It should go down under its own weight.
- ★ If the float does not move smoothly, replace the sender.

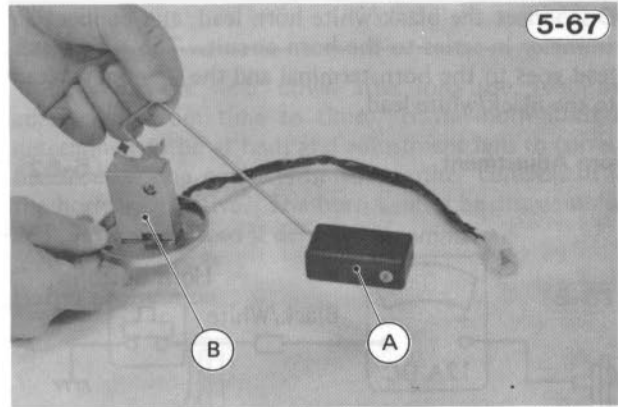

5-67

A. Float  
B. Fuel Level Sender

- Measure the resistance of the fuel level sender with an ohmmeter.
- ★ If the ohmmeter does not show the values in the table, or the reading does not vary smoothly as the fuel level changes, replace the sender.

Table 5-27 Resistance of Fuel Level Sender

Tank (Float)	Resistance
Full (Highest position)	0.5 – 5.5 Ω
Empty (Lowest position)	102 – 118 Ω

- Inspect the leads and 2-pin connector.
- ★ If they show any damage, replace the sender.

Fuel Gauge Check

- Open the headlight housing.
- Disconnect the 4-pin connector (colored black for the KZ1000-M) from the fuel gauge.
- Check the resistance of the gauge using an ohmmeter as shown in Table 5-28.
- ★ If the resistance in this test is found to be less than the proper value, there is a short in the gauge. No reading (∞) indicates an open circuit. In either case, replace the gauge.

Table 5-28 Gauge Internal Resistance

Meter Range	x 10 Ω
Connections	One meter lead → Brown lead The other meter lead → Black/yellow lead
Reading	KZ/Z1000-J and K: 170 – 185 Ω KZ1000-M : 50 – 60 Ω

Wiring Check

- Connect a voltmeter to the 4-pin gauge connector on the main wiring harness side as shown in the table, and turn on the ignition switch.
  - ★ If the voltmeter reading does not correspond to the table, the wiring is bad. Check the leads and connectors, and replace or repair any damaged wiring.
- NOTE:** 1. With one exception the gauge for the KZ1000-M is considered to be good even if the voltmeter needle fluctuates. The exception is when the

trouble is over-indication on the gauge (or indicating near the "F" mark when empty).

**Table 5-29 Wiring Check**

Meter Range	Connections	Reading
25V DC	Meter (+) → Brown lead Meter (-) → Black/yellow lead	Battery voltage

**ELECTRIC SPEEDOMETER, TACHOMETER, AND ODOMETER .**

The speedometer, tachometer, and odometer on the KZ1000-M are mechanically operated with the flexible cable; and those meters on the KZ/Z1000-J and K are electronically operated. As shown in the diagram, electric meters are powered by the battery.

**Electric Meter System Troubleshooting Guide:**

If trouble is suspected in the electric meter system, check the system by the following "Troubleshooting Guide" table and the test chart (Fig. 5-72 through 5-81).

The "Troubleshooting Guide" shows the relationship between various kind of symptoms of electric meter system trouble and the test chart by which the system

should be inspected. Each test procedure is explained individually on the pages before the charts.

- NOTE:** 1. All connectors that lead to the speedometer, tachometer, odometer, and speed sensor are in the headlight housing.
2. Explanation on each test procedure starts where the headlight unit has just been removed.
3. If the inspection proves that the electric meter system is good, but the system still shows trouble while riding; test the system with the engine running. Trouble may result from engine vibration.

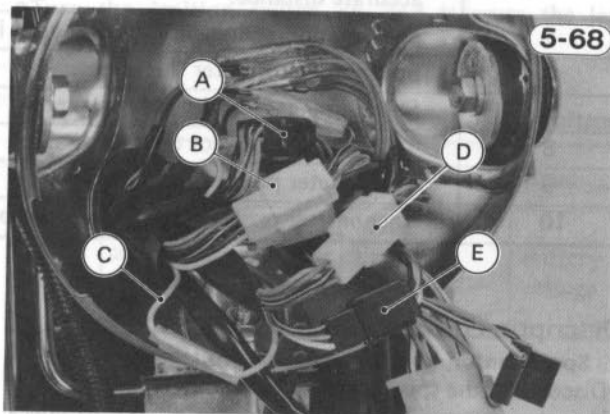

5-68

- A. Black, 6-pin, Tachometer Connector
- B. Yellow, 6-pin, Speedometer Connector
- C. Orange, Odometer Lead
- D. 6-pin, Odometer Connector (KZ/Z1000-K), or 3-pin, Odometer Connector (KZ/Z1000-J)
- E. Black, 3-pin, Speed Sensor Connector

**Electric Meter System**

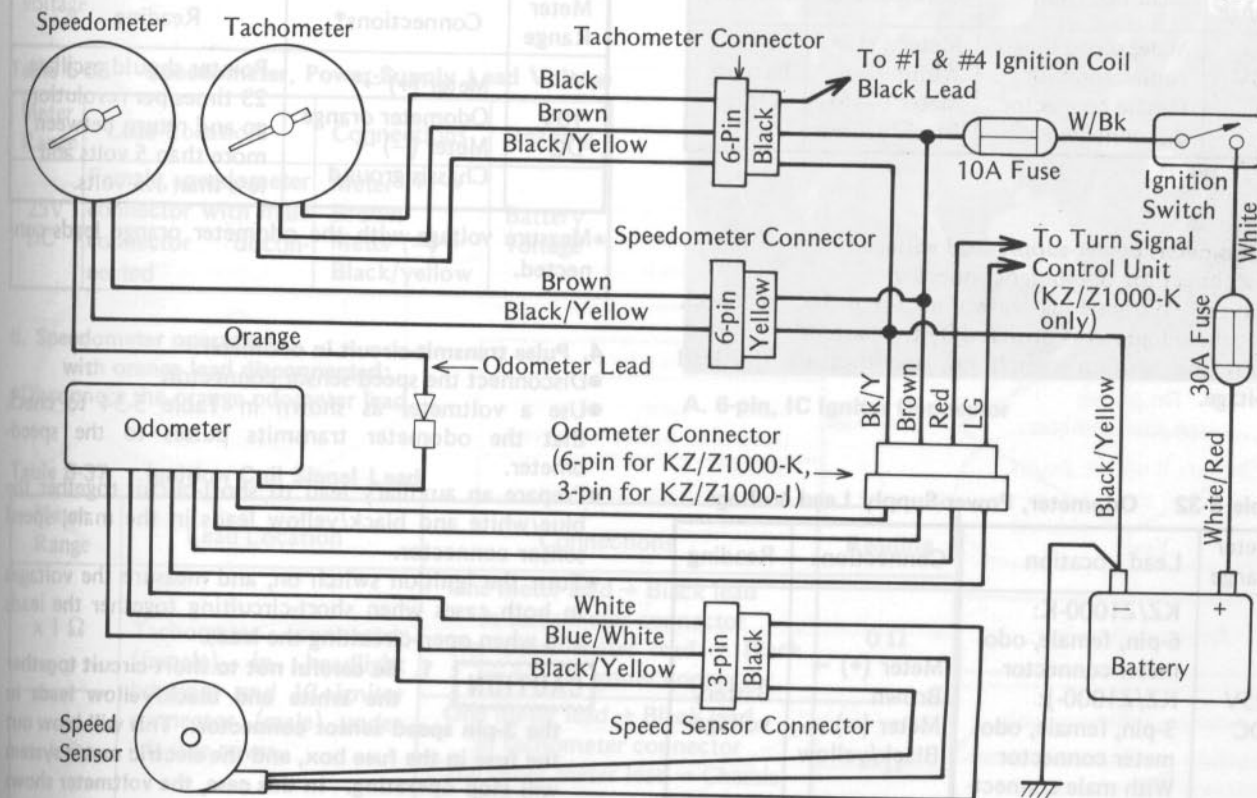

5-69

Table 5-30 Troubleshooting Guide

Test Chart No.	Symptoms	See Fig.
1	Neither odometer nor speedometer operates at all.	5-72
2	Odometer operates but speedometer does not operate at all.	5-73
3	Speedometer operates but odometer does not operate at all.	5-74
4	Speedometer operates normally but odometer reads inaccurate distance.	5-75
5	Both odometer and speedometer read inaccurately.	5-76
6	Speedometer pointer fluctuates.	5-77
7	Speedometer reads inaccurate speed.	5-78
8	Tachometer does not operate at all.	5-79
9	Tachometer pointer fluctuate.	5-80
10	Tachometer reads inaccurate engine speed.	5-81

### Description of Each Test Procedure:

#### 1. Speed sensor, power-supply lead voltage:

- Disconnect the speed sensor connector.
- Use the voltmeter as shown in Table 5-31 to check that the speed sensor is powered by the battery.
- Turn the ignition switch on, and measure the lead voltage.

Table 5-31 Speed-Sensor, Power-Supply Lead Voltage

Meter Range	Lead Location	Connections	Reading
25V DC	Male, speed sensor connector with female connector disconnected	Meter (+) → White Meter (-) → Black/yellow	Battery voltage

#### 2. Odometer, power-supply lead voltage:

- Disconnect the odometer connector.
- Use the voltmeter as shown in Table 5-32 to check that the odometer is powered by the battery.
- Turn the ignition switch on, and measure the lead voltage.

Table 5-32 Odometer, Power-Supply Lead Voltage

Meter Range	Lead Location	Connections	Reading
25V DC	KZ/Z1000-K: 6-pin, female, odometer connector KZ/Z1000-J: 3-pin, female, odometer connector With male connector disconnected	Meter (+) → Brown Meter (-) → Black/yellow	Battery voltage

#### 3. Pulses for speedometer:

- Raise the front wheel off the ground using a jack under the engine to turn the wheel freely.
- Use a voltmeter as shown in Table 5-33 to check that pulses sent from the speed sensor reach the speedometer.
- Turn the ignition switch on, and turning the front wheel slowly count how many times the meter pointer oscillates.

Table 5-33 Pulses for Speedometer

Meter Range	Connections*	Reading
10V DC	Meter (+) → Odometer orange Meter (-) → Chassis ground	Pointer should oscillate 23 times per revolution, go and return between more than 5 volts and less than 1.5 volts.

\*Measure voltage with the odometer orange leads connected.

#### 4. Pulse transmit-circuit in odometer:

- Disconnect the speed sensor connector.
- Use a voltmeter as shown in Table 5-34 to check that the odometer transmits pulses to the speedometer.
- Prepare an auxiliary lead to short-circuit together the blue/white and black/yellow leads in the male, speed sensor connector.
- Turn the ignition switch on, and measure the voltages in both cases when short-circuiting together the leads and when open-circuiting the leads.

#### CAUTION

1. Be careful not to short-circuit together the white and black/yellow leads in the 3-pin speed sensor connector. This will blow out the fuse in the fuse box, and the electric meter system will stop operating. In this case, the voltmeter shows zero volts.

Table 5-34 Pulse Transmit-Circuit in Odometer

Meter Range	Connections*	Reading
10V DC	Meter (+) → Odometer orange Meter (-) → Chassis ground	When short-circuiting: more than 5 volts When open-circuiting: less than 1.5 volts

\*Measure voltage with the odometer orange leads connected.

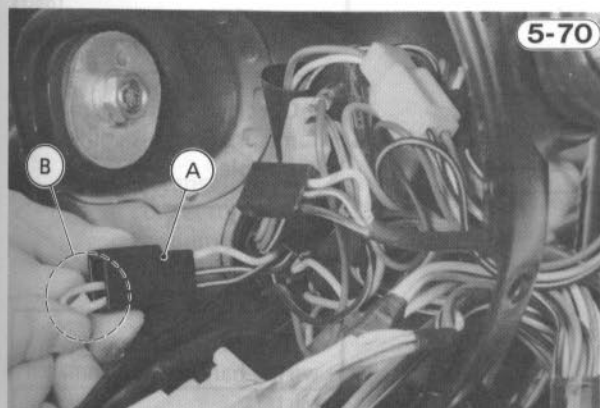

- A. Black, 3-pin, Speed Sensor Connector  
B. Short-circuit together blue/white and black/yellow leads

#### 5. Speedometer, power-supply lead voltage:

- Disconnect the speedometer connector.
- Use a voltmeter as shown in Table 5-35 to check that the speedometer is powered by the battery.
- Turn the ignition switch on, and measure the lead voltage.

Table 5-35 Speedometer, Power-Supply Lead Voltage

Meter Range	Lead Location	Connections	Reading
25V DC	Female, speedometer connector with male connector disconnected	Meter (+) → Brown Meter (-) → Black/yellow	Battery voltage

#### 6. Speedometer operation

with orange lead disconnected:

- Disconnect the orange odometer lead.

Table 5-37 Ignition Coil Signal Lead

Meter Range	Lead Location	Connections	Reading
x 1 $\Omega$	Tachometer connector (female) in headlight housing, and IC igniter connector (male) under left side cover	One meter lead → Black lead in tachometer connector The other meter lead → Black lead in IC igniter connector	0 $\Omega$
x k $\Omega$		One meter lead → Black lead in tachometer connector The other meter lead → Chassis ground	$\infty$ $\Omega$

- Raise the front wheel off the ground using a jack under the engine to turn the wheel freely.
- Turn the ignition switch on, and observe the speedometer.
- With the ignition switch on and turning the front wheel fast, observe the speedometer.

#### 7. Tachometer, power-supply lead voltage:

- Disconnect the tachometer connector.
- Use a voltmeter as shown in Table 5-36 to check that the tachometer is powered by the battery.
- Turn the ignition switch on, and measure the lead voltage.

Table 5-36 Tachometer, Power-Supply Lead Voltage

Meter Range	Lead Location	Connections	Reading
25V DC	Female, tachometer connector with male connector disconnected	Meter (+) → Brown Meter (-) → Black/yellow	Battery voltage

#### 8. Ignition coil signals:

- Disconnect the tachometer connector.
- Pull off the left side cover, and disconnect the IC igniter connector.
- Use an ohmmeter as shown in Table 5-37 to check the continuity of the lead which transmit the ignition coil signals to the tachometer.

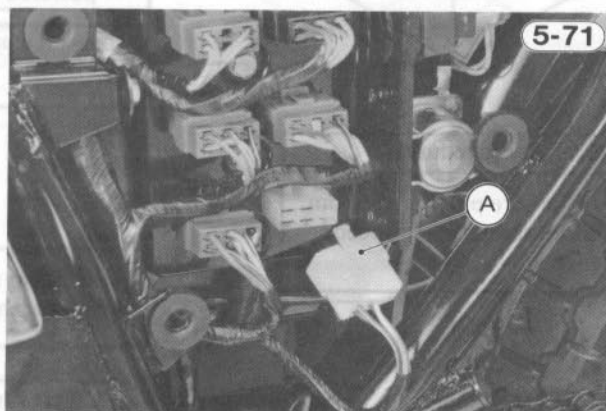

A. 6-pin, IC Igniter Connector

1. Neither odometer nor speedometer operates at all.

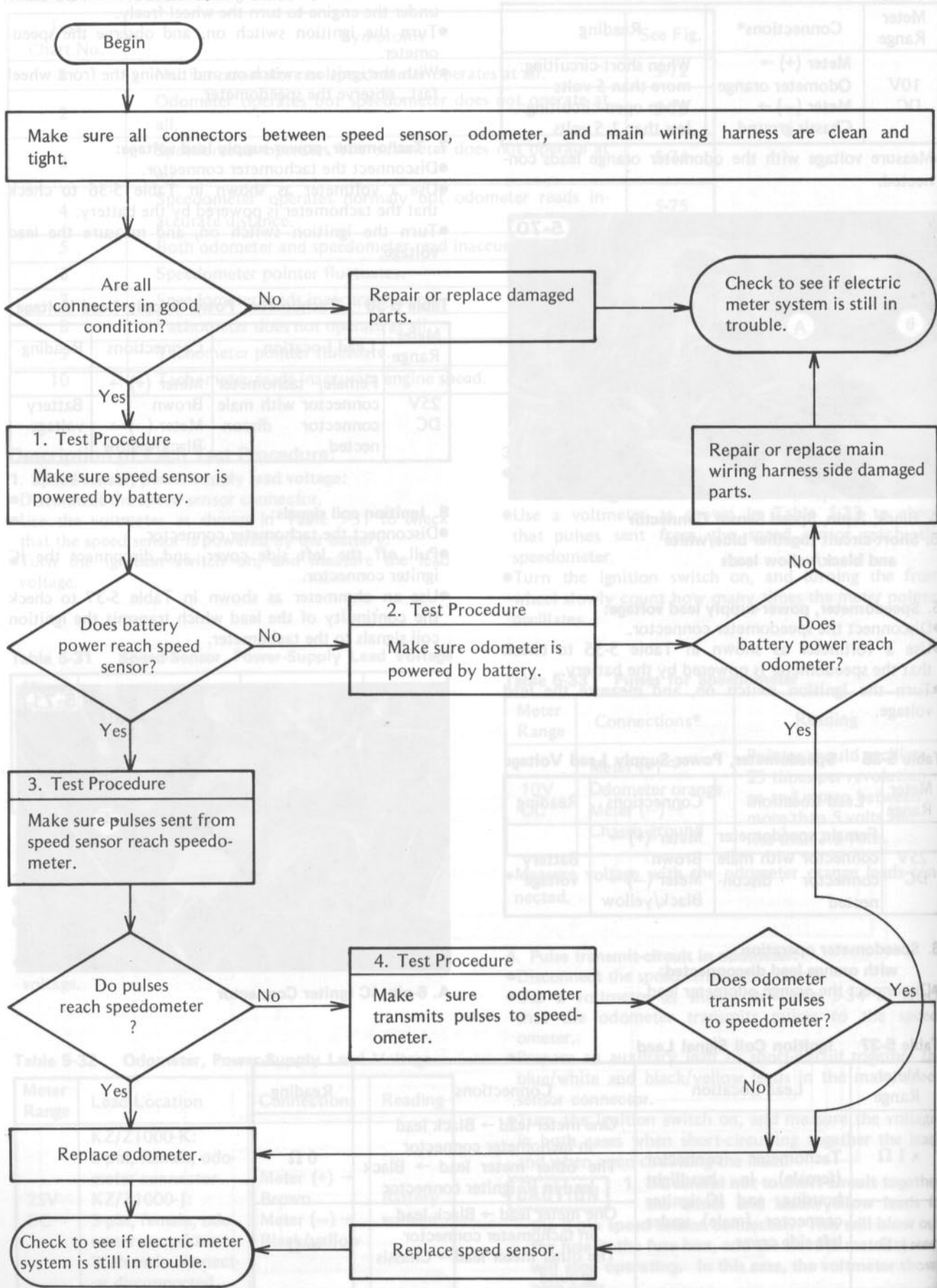

2. Odometer operates but speedometer does not operate at all.

5-73

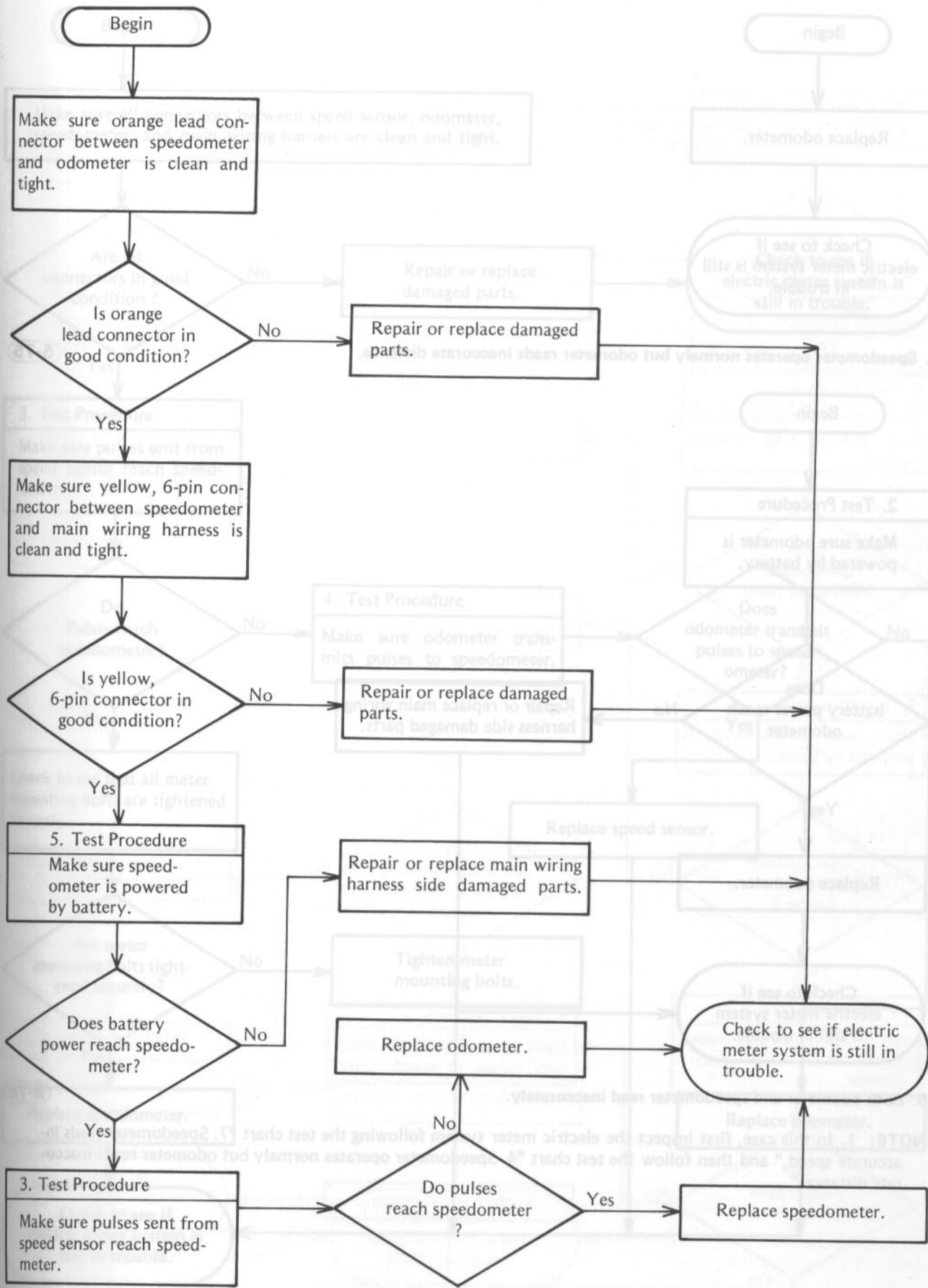

3. Speedometer operates but odometer does not operate at all.

5-74



4. Speedometer operates normally but odometer reads inaccurate distance.

5-75

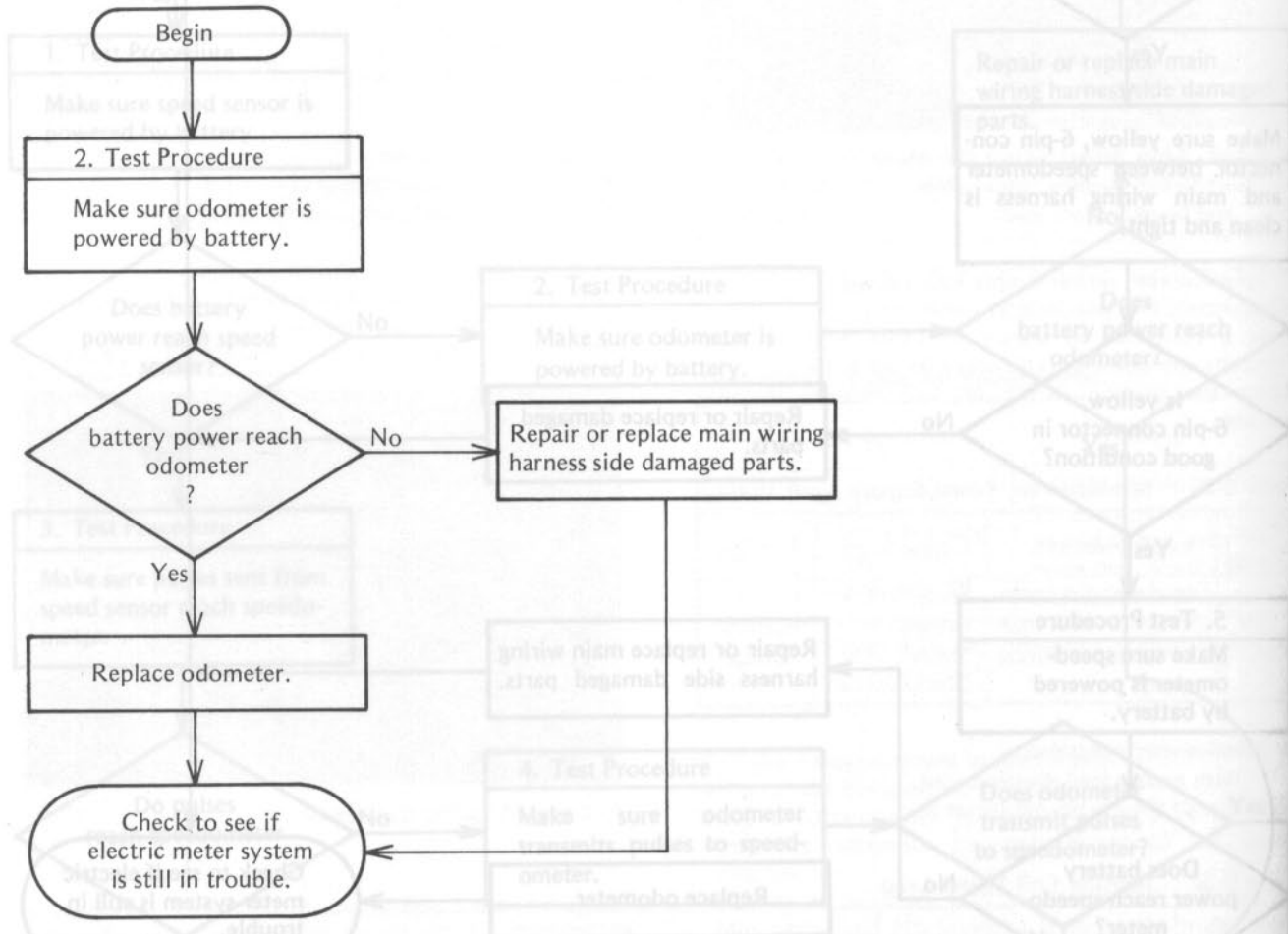

5. Both odometer and speedometer read inaccurately.

5-76

NOTE: 1. In this case, first inspect the electric meter system following the test chart "7. Speedometer reads inaccurate speed," and then follow the test chart "4. Speedometer operates normally but odometer reads inaccurate distance."

6. Speedometer pointer fluctuates.

5-77

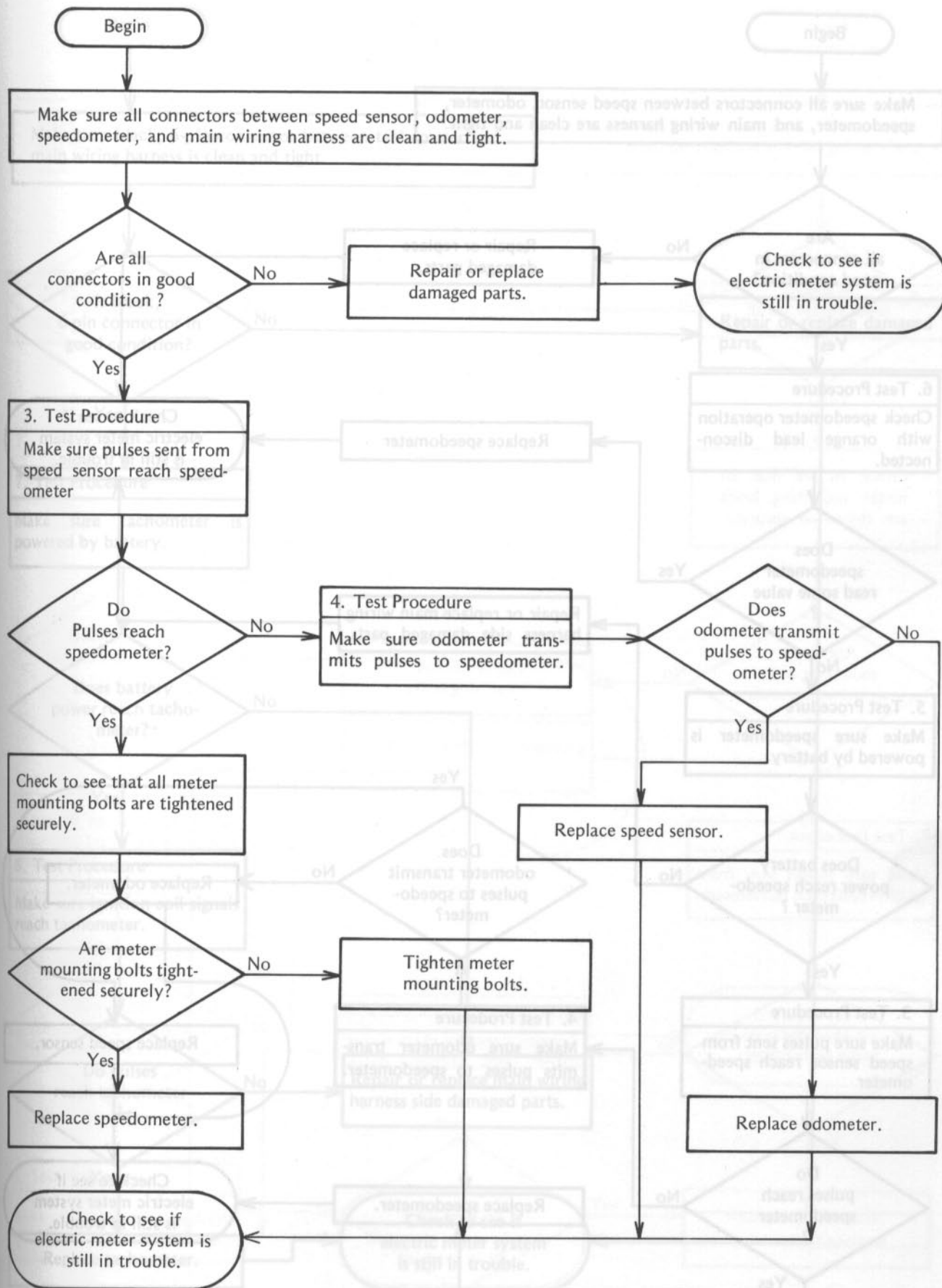



7. Speedometer reads inaccurate speed.

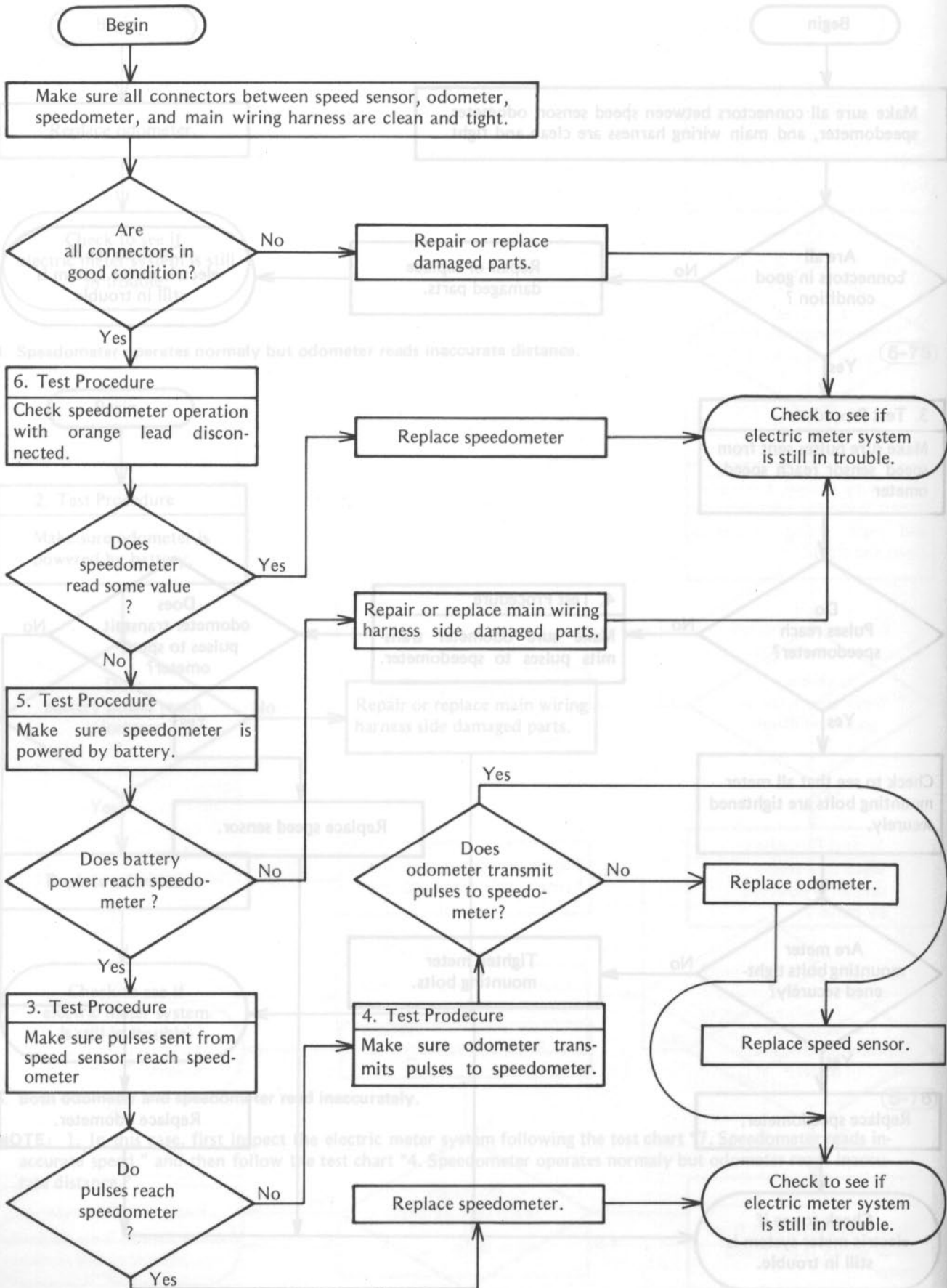

8. Tachometer does not operate at all.

5-79

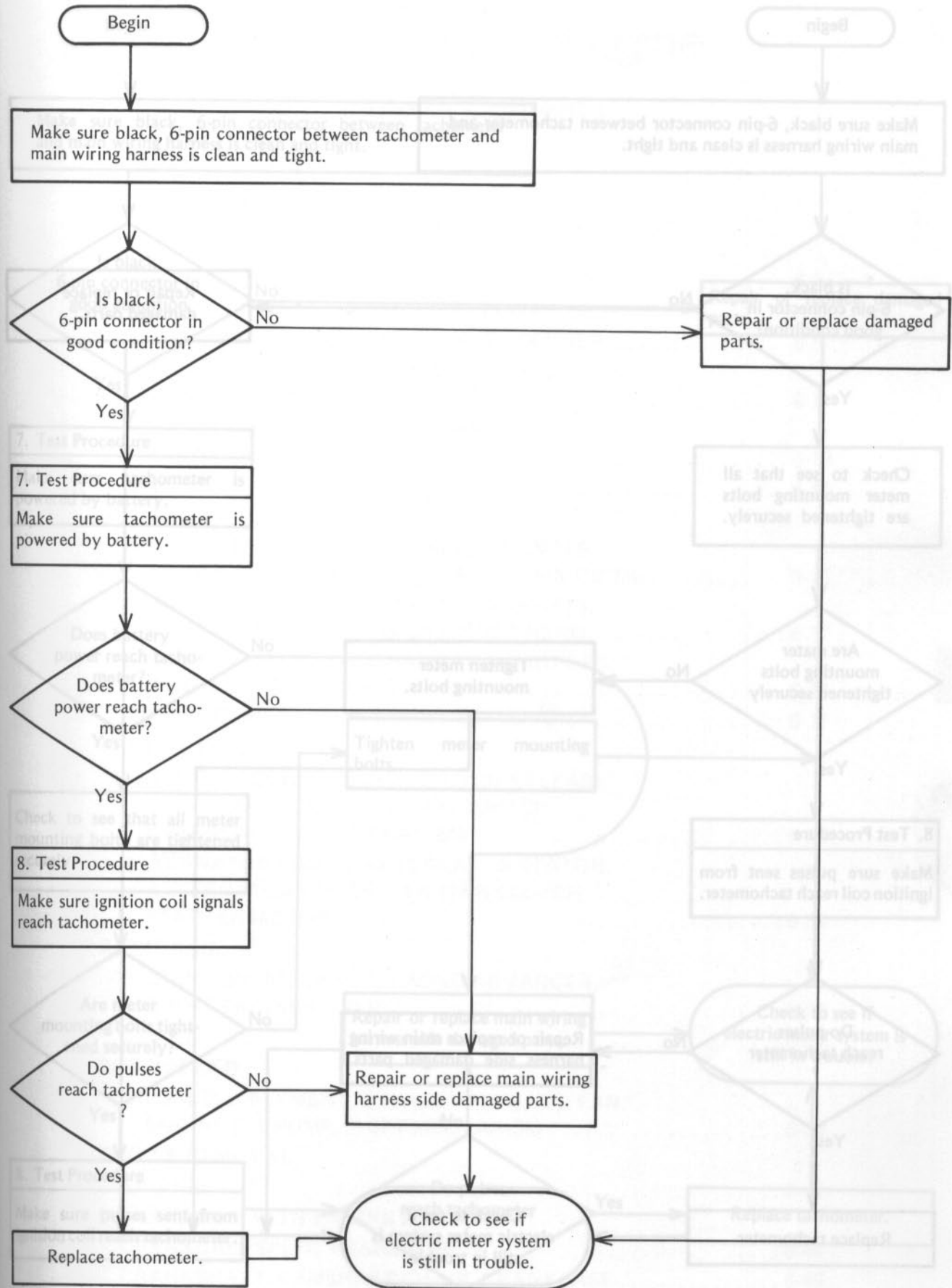

9. Tachometer pointer fluctuates.

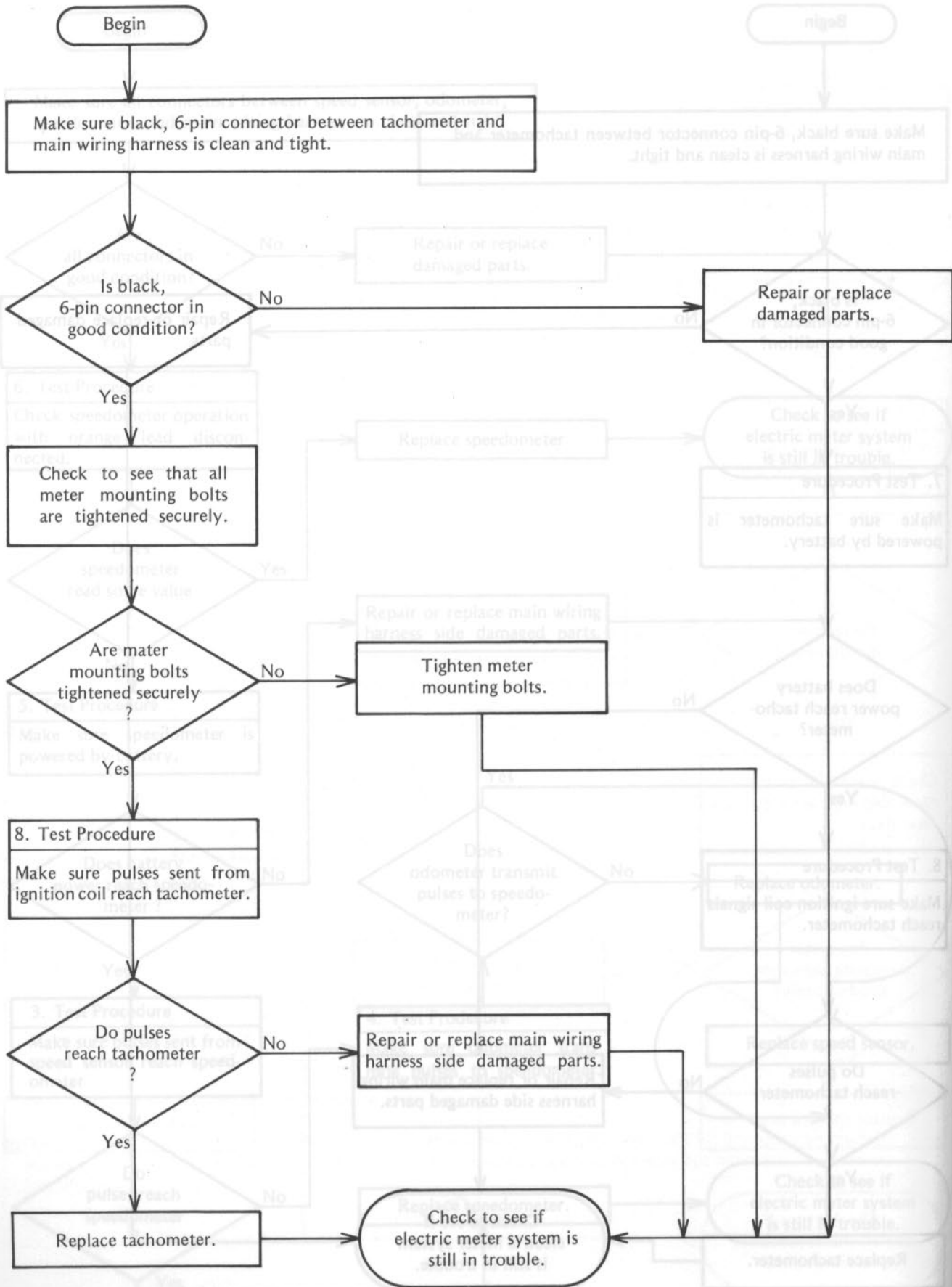

## 10. Tachometer reads inaccurate engine speed.

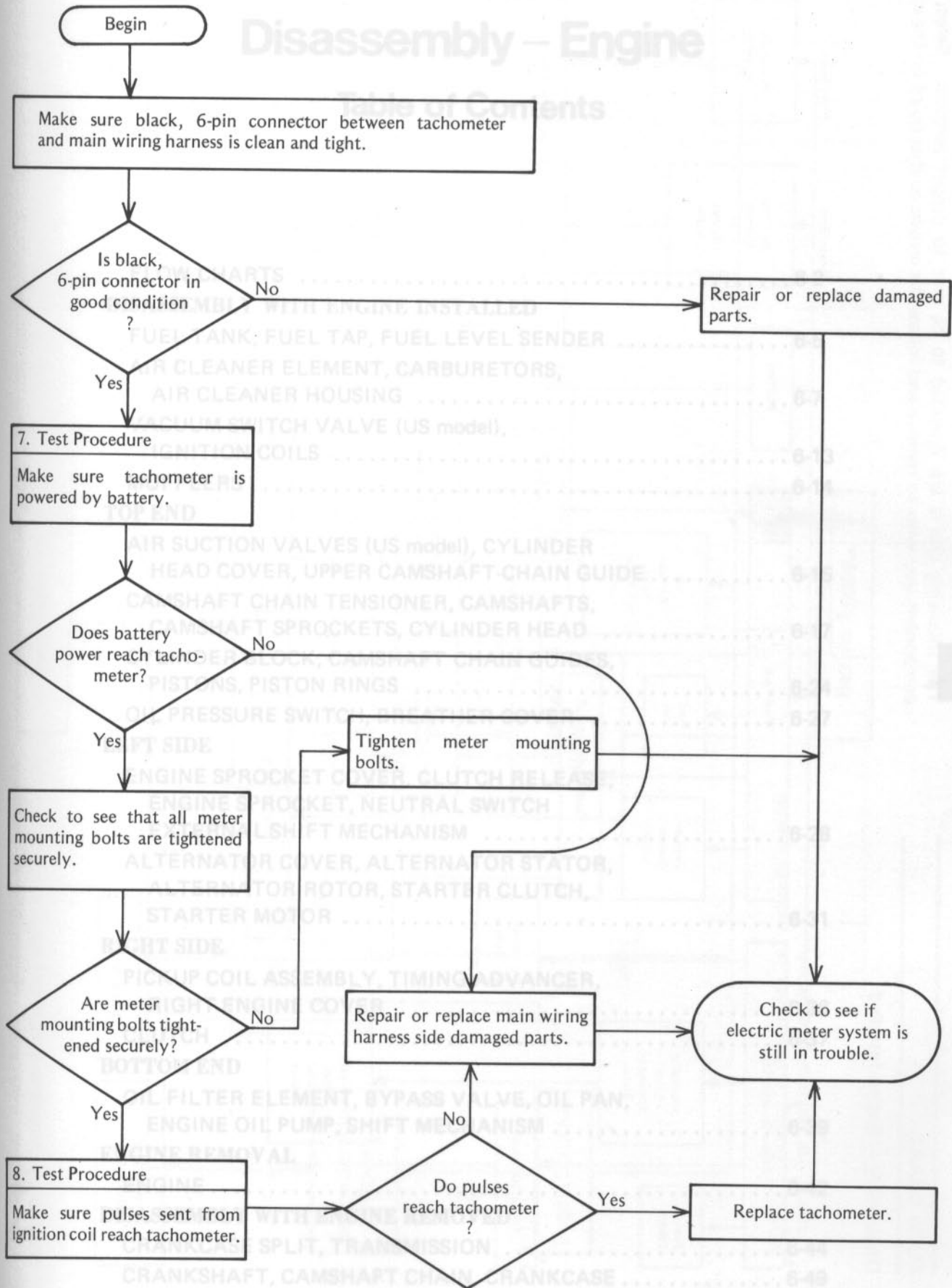

# Disassembly – Engine

## Table of Contents

FLOW CHARTS .....	6-2
<b>DISASSEMBLY WITH ENGINE INSTALLED</b>	
FUEL TANK, FUEL TAP, FUEL LEVEL SENDER .....	6-5
AIR CLEANER ELEMENT, CARBURETORS, AIR CLEANER HOUSING .....	6-7
VACUUM SWITCH VALVE (US model), IGNITION COILS .....	6-13
MUFFLERS .....	6-14
<b>TOP END</b>	
AIR SUCTION VALVES (US model), CYLINDER HEAD COVER, UPPER CAMSHAFT-CHAIN GUIDE .....	6-15
CAMSHAFT CHAIN TENSIONER, CAMSHAFTS, CAMSHAFT SPROCKETS, CYLINDER HEAD .....	6-17
CYLINDER BLOCK, CAMSHAFT CHAIN GUIDES, PISTONS, PISTON RINGS .....	6-24
OIL PRESSURE SWITCH, BREATHER COVER .....	6-27
<b>LEFT SIDE</b>	
ENGINE SPROCKET COVER, CLUTCH RELEASE, ENGINE SPROCKET, NEUTRAL SWITCH EXTERNAL SHIFT MECHANISM .....	6-28
ALTERNATOR COVER, ALTERNATOR STATOR, ALTERNATOR ROTOR, STARTER CLUTCH, STARTER MOTOR .....	6-31
<b>RIGHT SIDE</b>	
PICKUP COIL ASSEMBLY, TIMING ADVANCER, RIGHT ENGINE COVER .....	6-36
CLUTCH .....	6-37
<b>BOTTOM END</b>	
OIL FILTER ELEMENT, BYPASS VALVE, OIL PAN, ENGINE OIL PUMP, SHIFT MECHANISM .....	6-39
<b>ENGINE REMOVAL</b>	
ENGINE .....	6-42
<b>DISASSEMBLY WITH ENGINE REMOVED</b>	
CRANKCASE SPLIT, TRANSMISSION .....	6-44
CRANKSHAFT, CAMSHAFT CHAIN, CRANKCASE .....	6-49

The following charts are intended to be aids to proper removal. Select the component you wish to remove and follow the arrows to that point on the chart.

FLOW CHART

Disassembly - Engine Installed

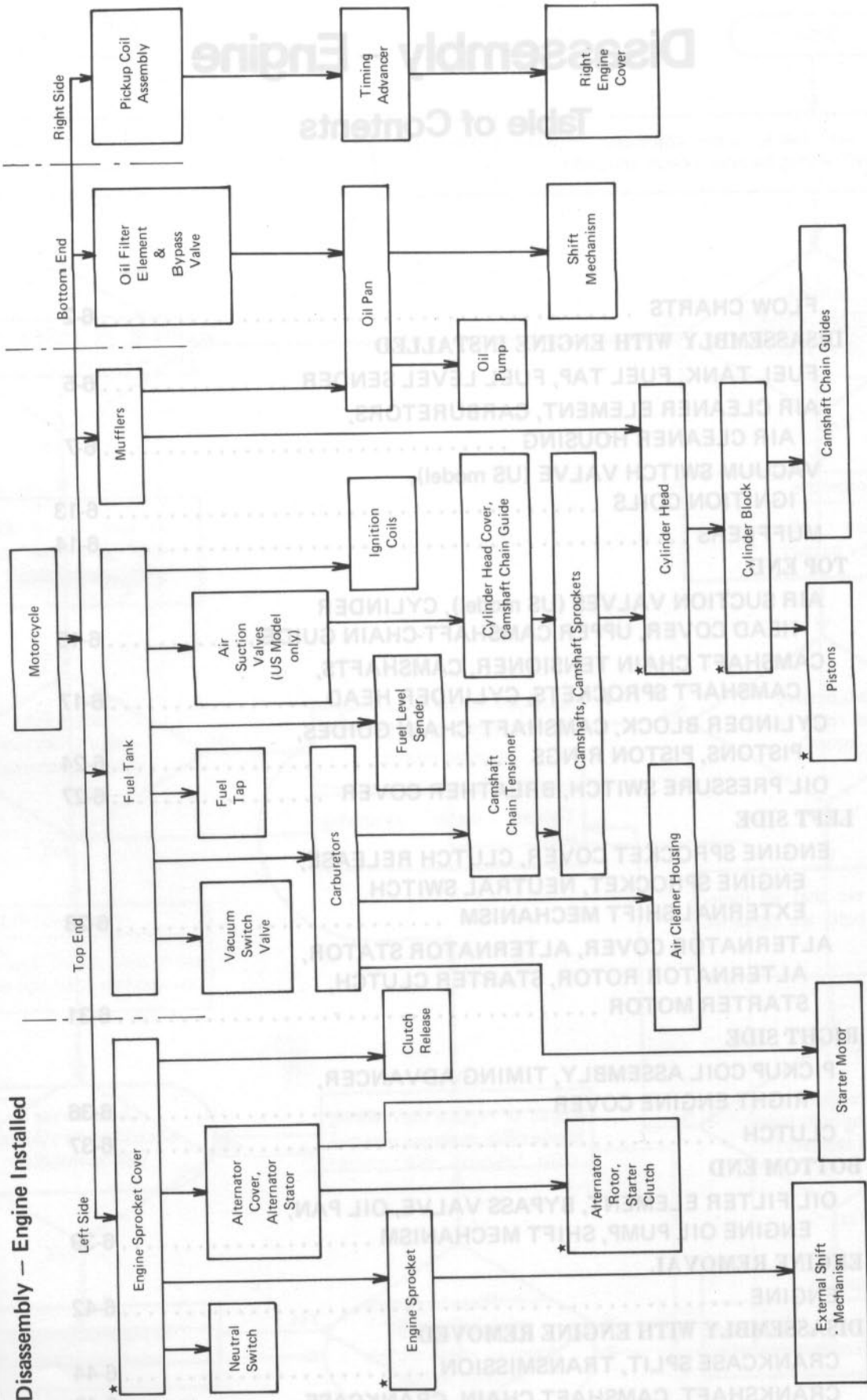

NOTE: 1. Action with a mark (★) requires special tool(s) for removal, installation, disassembly, or assembly.

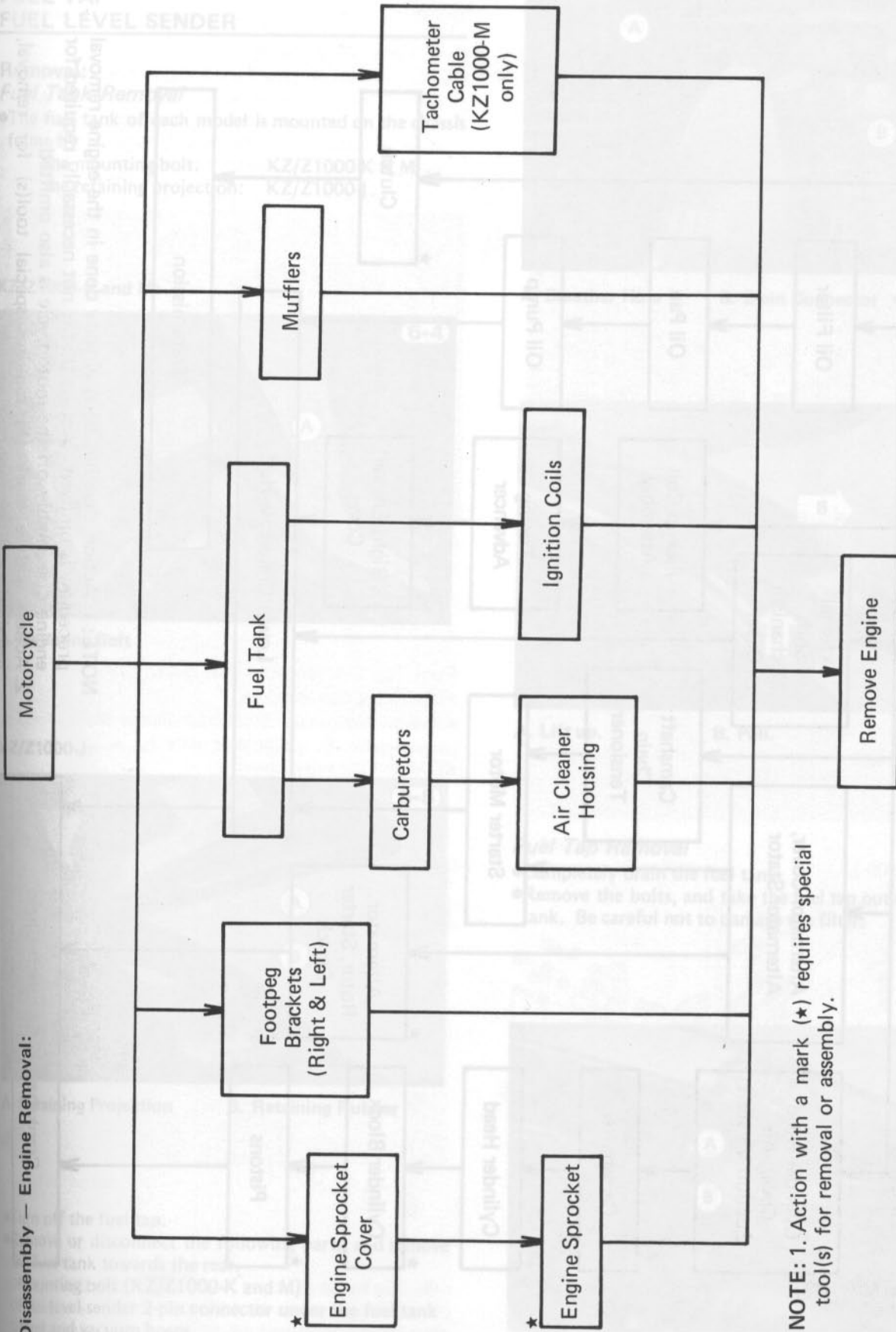

Disassembly — Engine Removal:

NOTE: 1. Action with a mark (★) requires special tool(s) for removal or assembly.

Disassembly — Engine Removed:

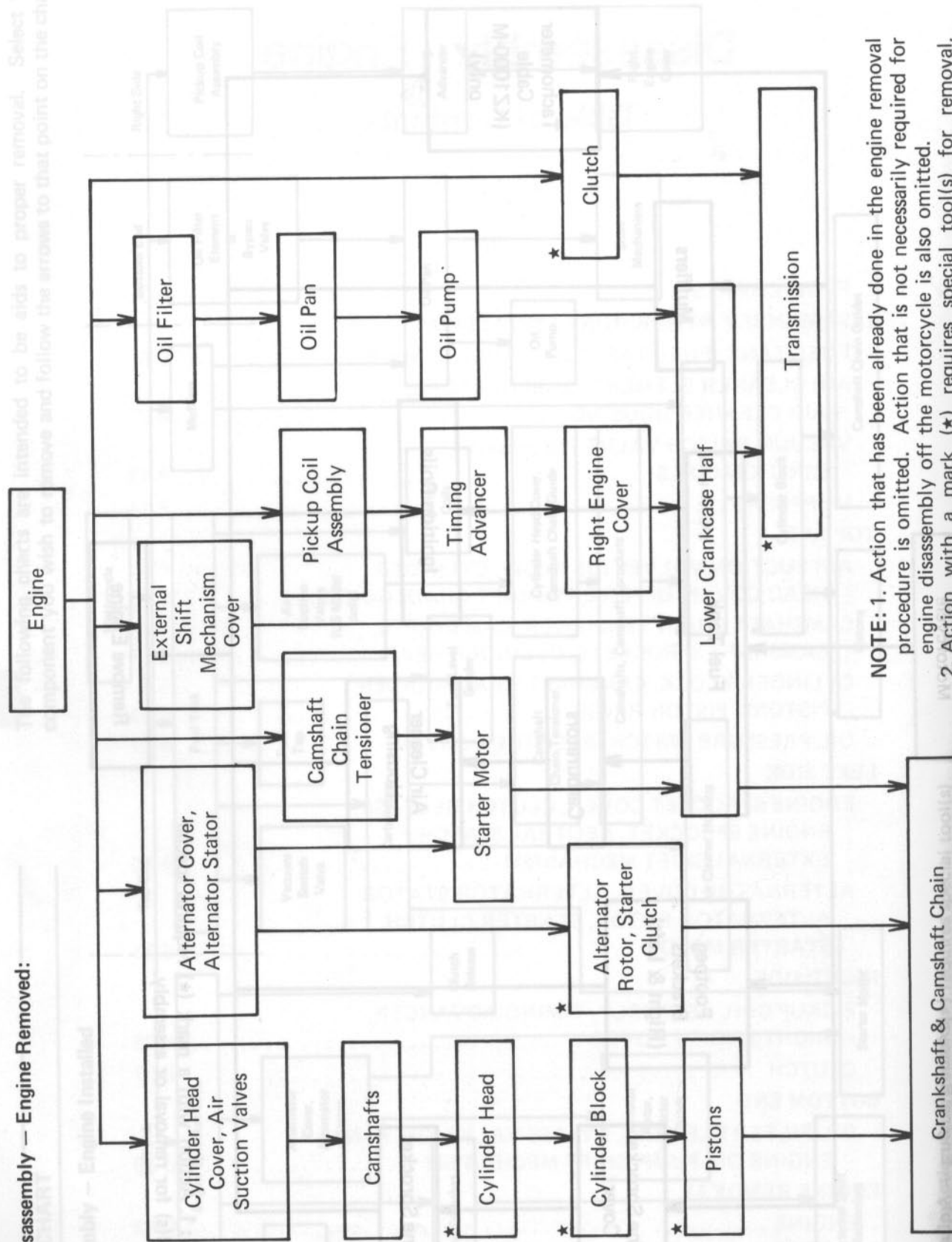

**NOTE:** 1. Action that has been already done in the engine removal procedure is omitted. Action that is not necessarily required for engine disassembly off the motorcycle is also omitted.  
 2. Action with a mark (\*) requires special tool(s) for removal, installation, disassembly, or assembly.



## FUEL TANK FUEL TAP FUEL LEVEL SENDER

### Removal:

#### Fuel Tank Removal

- The fuel tank of each model is mounted on the chassis frame by

the mounting bolt: KZ/Z1000-K & M.

the retaining projection: KZ/Z1000-J.

KZ/Z1000-K and M:

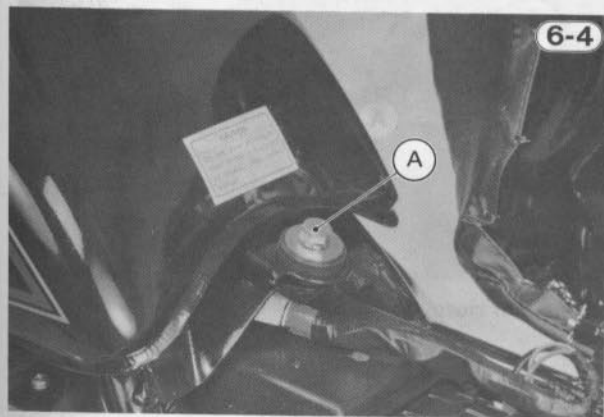

A. Mounting Bolt

KZ/Z1000-J:

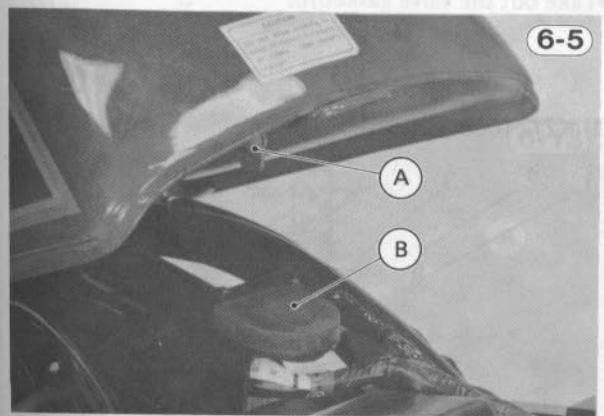

A. Retaining Projection

B. Retaining Rubber

- Turn off the fuel tap.
- Remove or disconnect the following parts, and remove the fuel tank towards the rear.
  - Mounting bolt (KZ/Z1000-K and M)
  - Fuel level sender 2-pin connector under the fuel tank
  - Fuel and vacuum hoses
  - Fuel tank breather hose

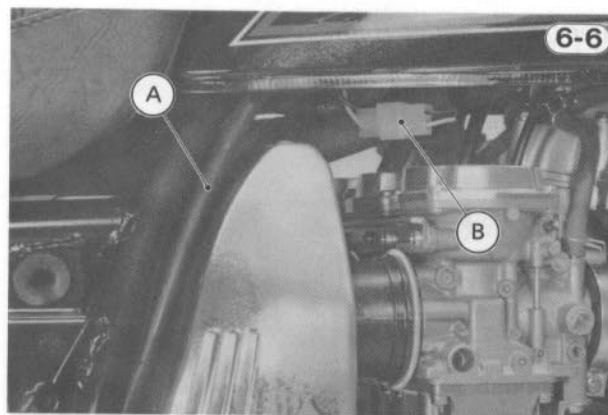

A. Breather Hose

B. 2-pin Connector

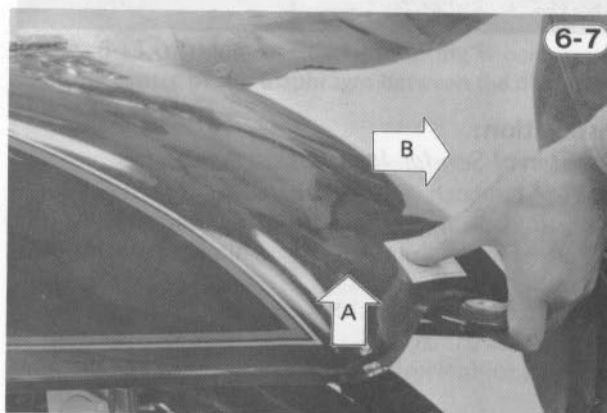

A. Lift up.

B. Pull.

#### Fuel Tap Removal

- Completely drain the fuel tank.
- Remove the bolts, and take the fuel tap out of the fuel tank. Be careful not to damage the filter.

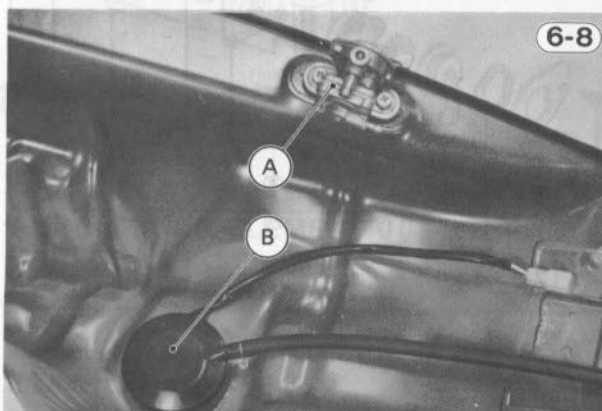

A. Fuel Tap

B. Fuel Level Sender

**Fuel Level Sender Removal**

- Remove the fuel level sender cover and breather hose prying the cover flange outside.
- Remove the bolts (5), and remove the sender. Be careful not to bend the float arm.

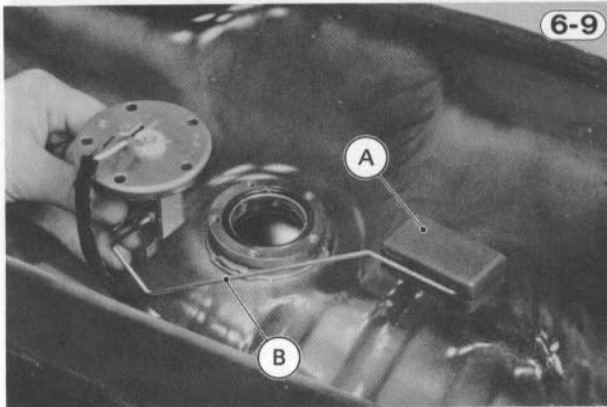

A. Float      B. Arm

**Installation:**

**Fuel Level Sender Installation**

- NOTE:** 1. Match the bolt holes so that the float is positioned directly forward of the sender body (Fig. 6-9). Float movement will be hindered in any other position.
2. Replace the O-ring with a new one, if it is swollen or otherwise damaged.
  3. Check for fuel leak after installing and filling the tank.

**Fuel Tap Installation**

- NOTE:** 1. Replace the O-ring and gasket with new ones, if they are swollen or otherwise damaged.

**Fuel Tap**

(1) KZ/Z1000-J

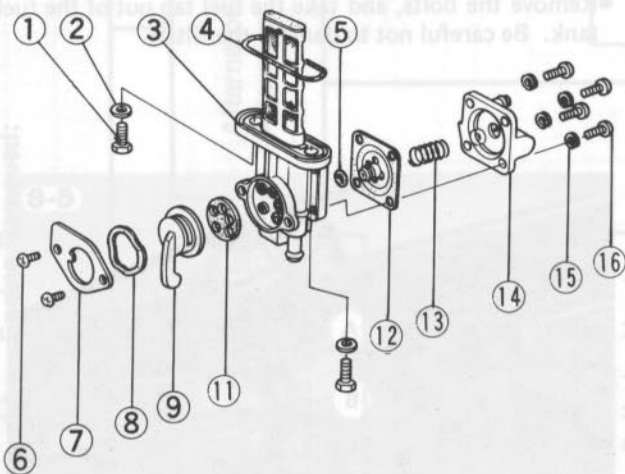

- |                  |                  |
|------------------|------------------|
| 1. Mounting Bolt | 5. O-Ring        |
| 2. Gasket        | 6. Screw         |
| 3. Tap Body      | 7. Holding Plate |
| 4. O-Ring        | 8. Wave Washer   |

2. Check for fuel leak after installing and filling the tank.

**Fuel Tank Installation**

- NOTE:** 1. Run the fuel tank breather hose on the right side of the air cleaner housing as shown in Fig. 6-6.
2. Fit the fuel and vacuum hoses back onto the fuel tap, slide the clamps back into place. The vacuum hose has a smaller diameter than the fuel hose.

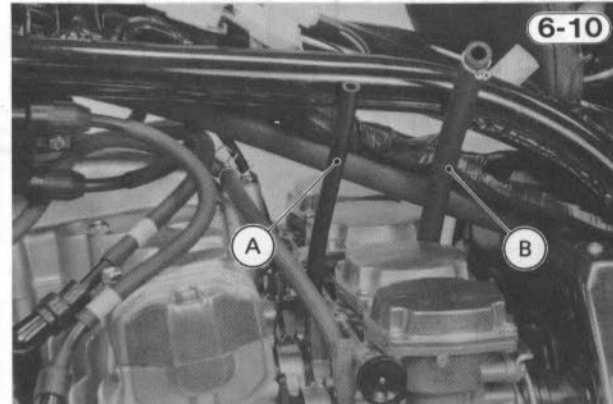

A. Vacuum Hose      B. Fuel Hose

3. Replace the fuel and vacuum hoses with new ones if they are hardened or damaged.

**Fuel Tap Disassembly and Assembly:**

**Fuel Tap Disassembly**

- Remove the screws (6) (2), and remove the tap lever (9), wave washer (8), and holding plate (7).
- Take out the valve gasket (11).

6-11

(2) KZ/Z1000-K and M:

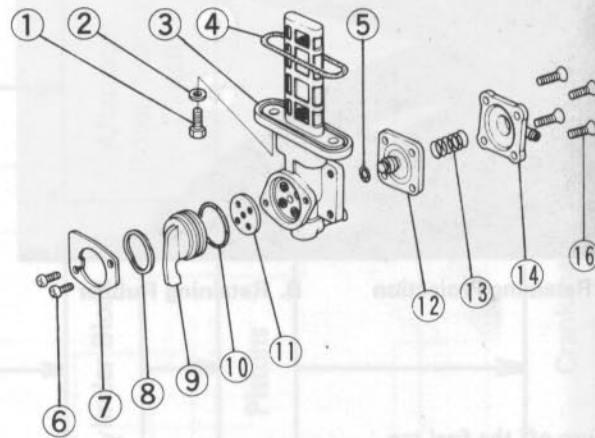

- |                        |                |
|------------------------|----------------|
| 9. Tap Lever           | 13. Spring     |
| 10. O-Ring             | 14. Cover      |
| 11. Valve Gasket       | 15. Lockwasher |
| 12. Diaphragm Assembly | 16. Screw      |

- Remove the screws ⑩ and lockwashers ⑮ (4 ea), and remove the diaphragm cover ⑭ and spring ⑬.
- Remove the diaphragm assembly ⑫ from the fuel tap.

### Fuel Tap Assembly

#### NOTE:

- KZ/Z1000-K and M:**
1. Check and clean all the parts (Pg. 3-2). Replace damaged parts with new ones.
  2. Install the diaphragm plate so that the groove in the plate faces to the O-ring side.
  3. Install the valve gasket on the fuel tap body so that the gasket holes perfectly match the tap body holes and projections.

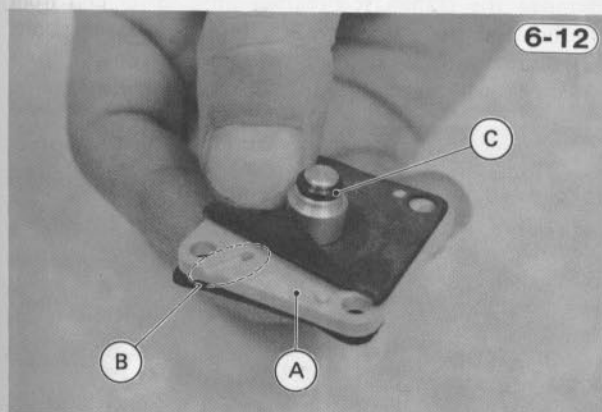

A. Diaphragm Plate      B. Groove      C. O-Ring

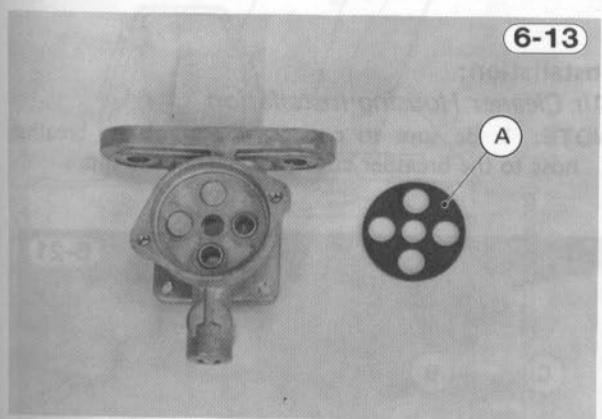

A. Valve Gasket

4. Install the diaphragm cover in the direction shown in Fig. 6-14, making sure that the spring is compressed at the center of the diaphragm between the diaphragm and the cover.

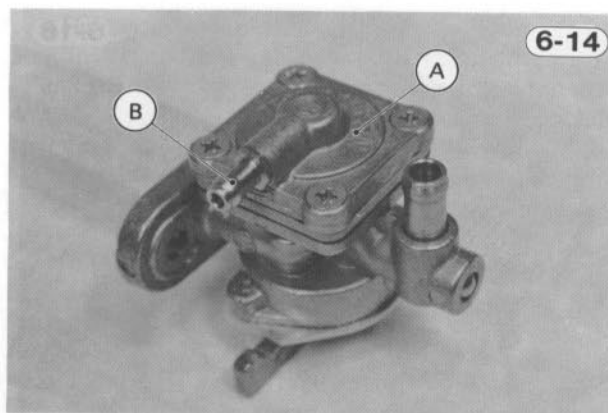

A. Diaphragm Cover      B. Vacuum Hose Fitting

- KZ/Z1000-J:**
1. Check and clean all the parts. Replace damaged parts with new ones.

2. Install the diaphragm cover in the direction shown in Fig. 6-15, making sure that the spring is compressed at the center of the diaphragm between the diaphragm and the cover.

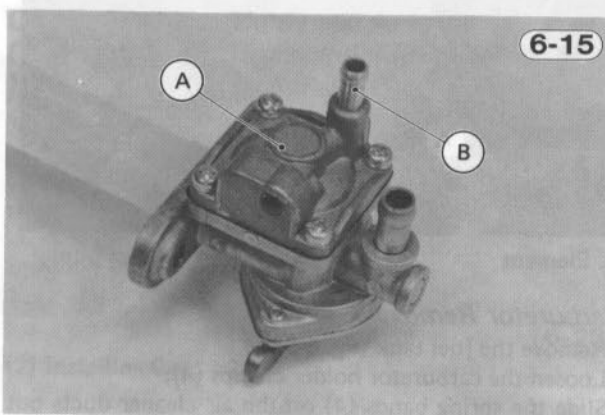

A. Diaphragm Cover      B. Vacuum Hose Fitting

## AIR CLEANER ELEMENT CARBURETORS AIR CLEANER HOUSING

### Removal:

#### Element Removal

- Unlock and open the seat.
- Remove the air cleaner cap screws.

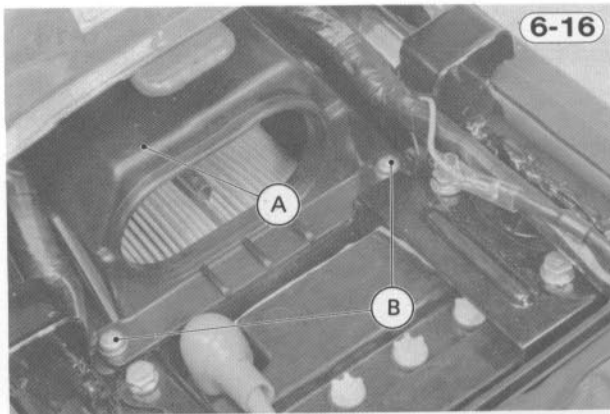

A. Air Cleaner Cap B. Screws

- Remove the air cleaner cap, and pull out the element.

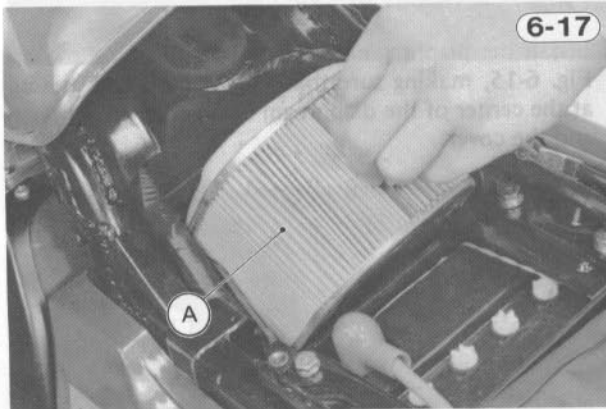

A. Element

#### Carburetor Removal

- Remove the fuel tank (Pg. 6-5).
- Loosen the carburetor holder clamps (4).
- Slide the spring bands (4) on the air cleaner ducts out of place.

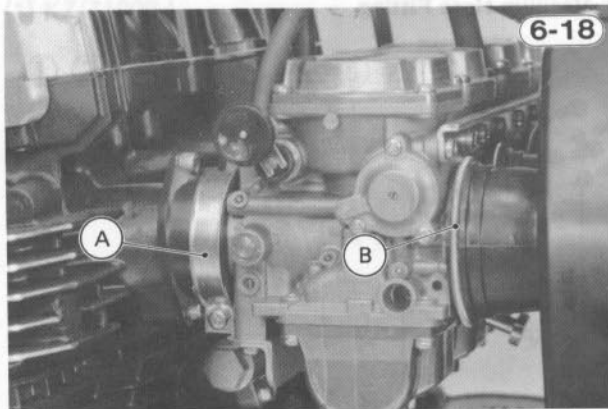

A. Carburetor Holder Clamp B. Spring Band

- Disconnect the following parts from the carburetors, and slip the carburetors up and out of place to the right side.
  - Throttle cable lower end
  - Vacuum hoses to the vacuum switch valve (US model only)

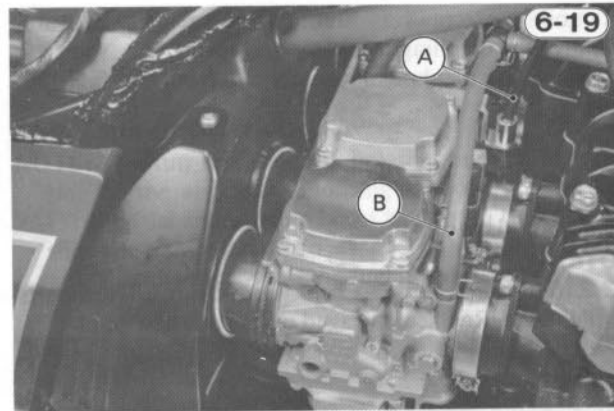

A. Throttle Cable  
B. Hoses to Vacuum Switch Valve (US model only)

#### Air Cleaner Housing Removal

- Remove the battery (Pg. 7-25).
- Remove the crankcase breather hose lower end from the breather cover, remove the housing mounting bolts (2), and remove the housing towards the front.

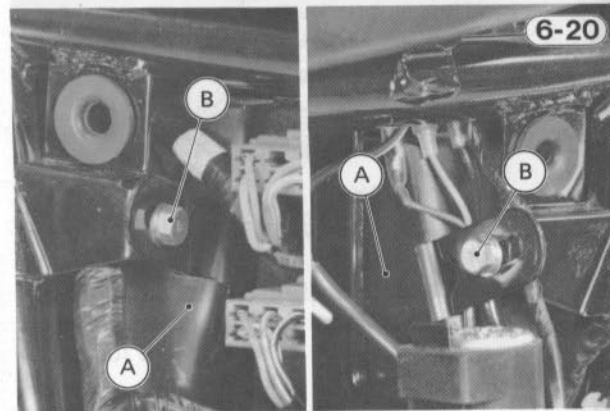

A. Air Cleaner Housing B. Bolt

#### Installation:

##### Air Cleaner Housing Installation

- NOTE:** 1. Be sure to connect the crankcase breather hose to the breather cover, and install the clip.

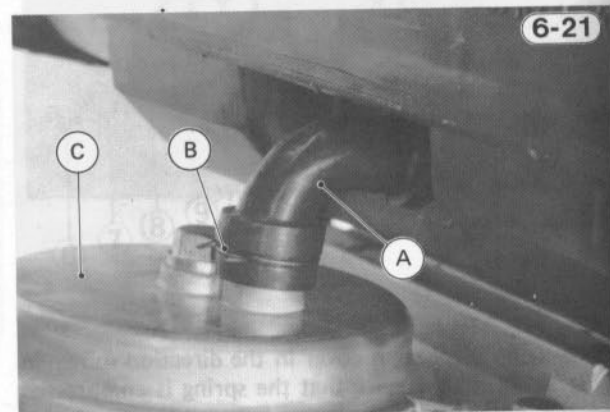

A. Breather Hose B. Clip C. Breather Cover

### Carburetor installation

- NOTE:** 1. Check the carburetor holders for crack or other damage, replace the damaged holders with new ones. Apply a non-permanent locking agent to the carburetor holder mounting bolt threads.
2. If the carburetors were disassembled, visually synchronize the throttle (butterfly) valves as follows:
- Check to see that all butterfly valves open and close smoothly without no binding when turning the pulley.
  - Visually check the clearance between the butterfly valve and the carburetor bore in each carburetor.

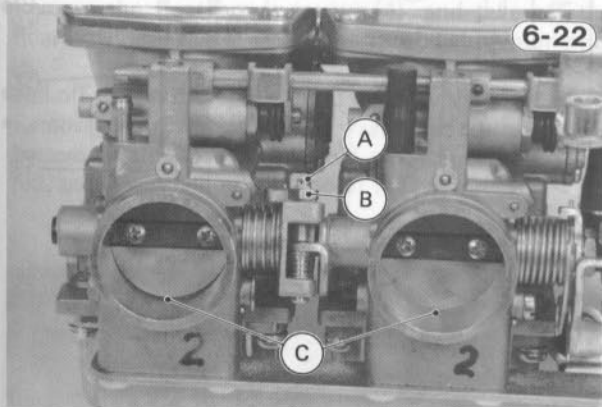

A. Balance Adjusting Screw  
B. Locknut  
C. Clearance

- If there is a difference between any two carburetors, loosen the locknut(s) and turn the balance adjusting screw(s) to obtain the same clearance.

### Air Cleaner Element Installation

(1) Installing element

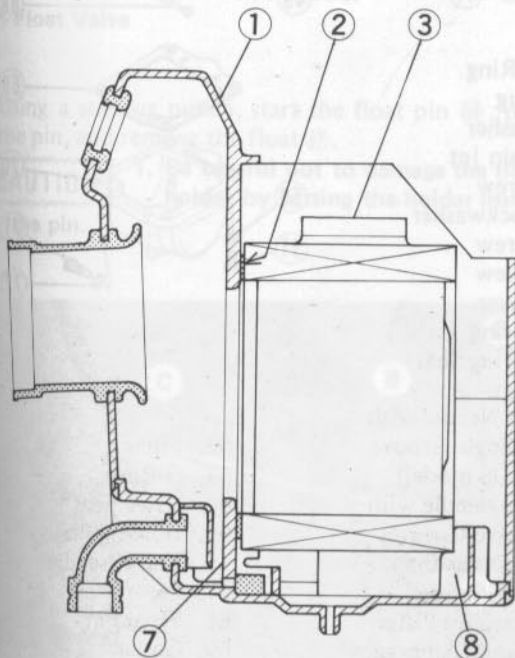

1. Air Cleaner Housing  
2. Sponge Gasket  
3. Air Cleaner Element

- Tighten the locknut(s).
3. Run the throttle cable between the right fork leg and the head pipe, and right side of the frame top tube.
  4. Connect the vacuum hose(s) to the following hose fittings:
    - Two hoses to the vacuum switch valve (US model only) → # 1 and # 4 carburetors
    - One hose to fuel tap → # 2 carburetor
  5. After completing installation, adjust the throttle grip (Pg. 2-10) and the carburetors (Pg. 2-10).

### Element Installation

- Taking care not to push the sponge gasket out of place, install the element in the housing.

- NOTE:** 1. The open side of the element must face to the front.
2. The bottom part of the element must be between the partition wall and the element seat in the housing.
- Install the air cleaner cap fitting its flange into the housing, and tighten the screws(2).

- NOTE:** 1. When the element and cap are properly installed, the holder on the cap keeps the element from moving towards the rear.

### Carburetor Disassembly and Assembly:

#### Carburetor Body Disassembly (each carburetor)

- NOTE:** 1. The carburetor parts listed below can be removed without separating the carburetors from the mounting plates.
- Vacuum Piston and Diaphragm Assembly
  - Jet Needle
  - Needle Jet
  - Pilot Screw

(2) Installing Cap

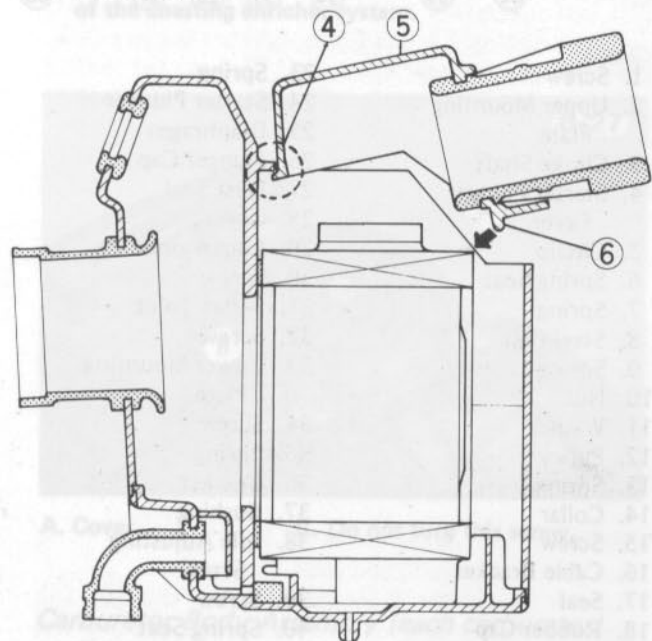

4. Fit cap flange into housing.  
5. Air Cleaner Cap  
6. Holder  
7. Partition Wall  
8. Seat

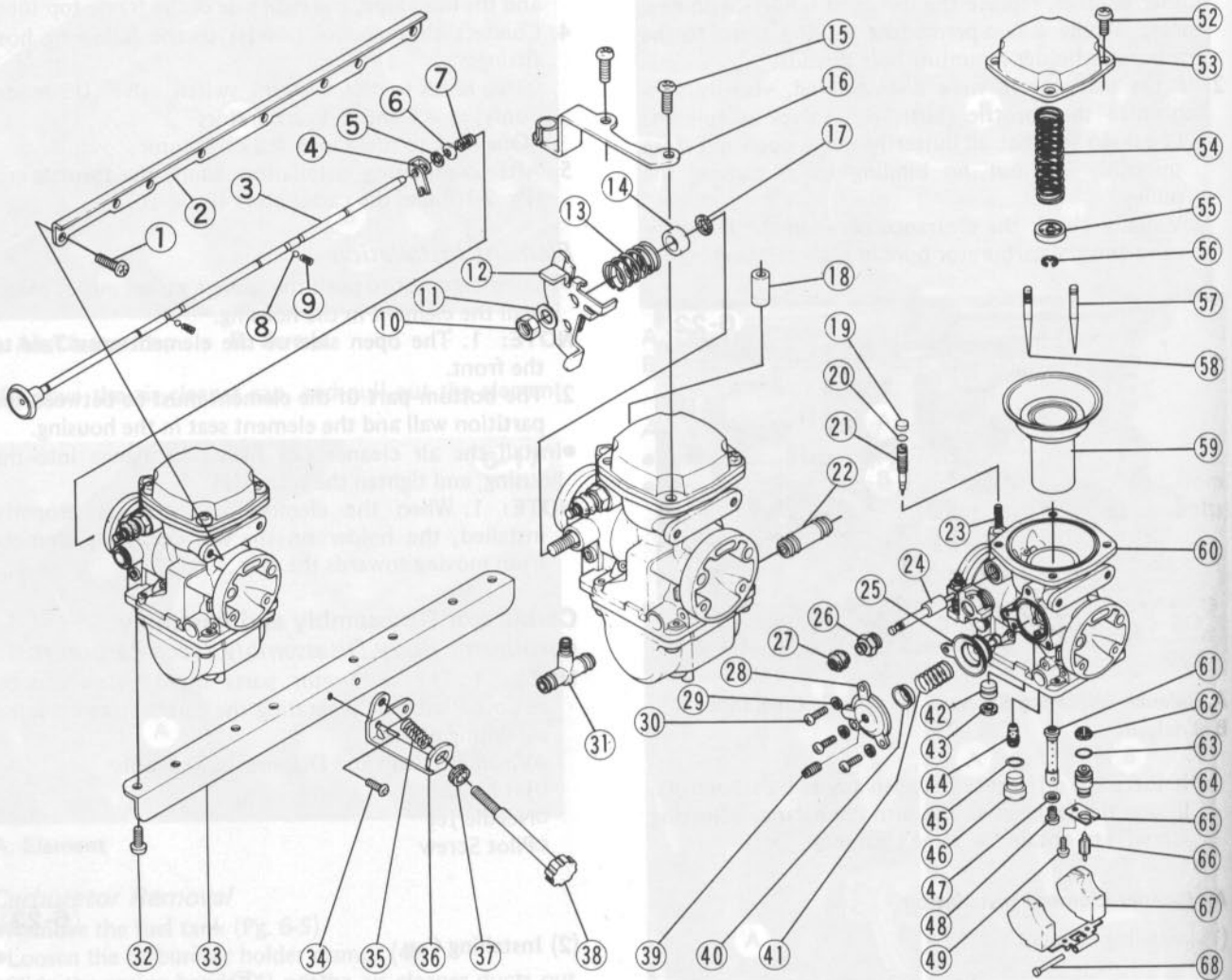

- |                          |                          |  |                   |
|--------------------------|--------------------------|--|-------------------|
| 1. Screw                 | 23. Spring               | 45. O-Ring   | 62. Filter        |
| 2. Upper Mounting Plate  | 24. Starter Plunger      | 46. Plug   | 63. O-Ring        |
| 3. Choke Shaft           | 25. Diaphragm            | 47. Washer   | 64. Valve Seat    |
| 4. Starter Plunger Lever | 26. Plunger Cap          | 48. Main Jet   | 65. Holding Plate |
| 5. Circlip               | 27. Dust Seal            | 49. Screw  | 66. Valve Needle  |
| 6. Spring Seat           | 28. Cover                | 50. Lockwasher   | 67. Float         |
| 7. Spring                | 29. Lockwasher           | 51. Screw  | 68. Float Pin     |
| 8. Steel Ball            | 30. Screw                | 52. Screw  | 69. Gasket        |
| 9. Spring                | 31. 3-Way Joint          | 53. Cover  | 70. Float Bowl    |
| 10. Nut                  | 32. Screw                | 54. Spring   | 71. Drain Plug    |
| 11. Washer               | 33. Lower Mounting Plate | 55. Spring Seat  | 72. O-Ring        |
| 12. Pulley               | 34. Screw                | 56. Clip   |                   |
| 13. Spring               | 35. Spring               | 57. Jet Needle with Single Groove (US model)           |                   |
| 14. Collar               | 36. Bracket              | 58. Jet Needle with Five Grooves (Other than US model) |                   |
| 15. Screw                | 37. Bushing              | 59. Vacuum Piston and Diaphragm Assembly               |                   |
| 16. Cable Bracket        | 38. Idle Adjusting Screw | 60. Carburetor Body                                    |                   |
| 17. Seal                 | 39. Screw                | 61. Needle Jet   |                   |
| 18. Rubber Cap           | 40. Spring Seat          |  |                   |
| 19. Plug (US model)      | 41. Spring               |  |                   |
| 20. O-Ring               | 42. Plug                 |  |                   |
| 21. Pilot Screw          | 43. O-Ring               |  |                   |
| 22. Joint                | 44. Pilot Jet            |  |                   |

- Pilot Jet
- Main Jet
- Float
- Float Valve Needle
- Float Valve Seat

2. The carburetor parts listed below can be removed after separating the carburetors from the mounting plates.

- Starter Plunger
- Coasting Enricher (KZ/Z1000-J)

#### Bottom end:

- Remove the float bowls screws (4), and take off the float bowl (70), gasket (69), O-ring (43), and aluminum plug (42).
- Pull off the plastic plug (46), and unscrew the pilot jet (44).
- Remove the main jet (48) and washer, and push on the bottom of the needle jet with a wooden or other soft rod, and it will fall out the top of the carburetor.

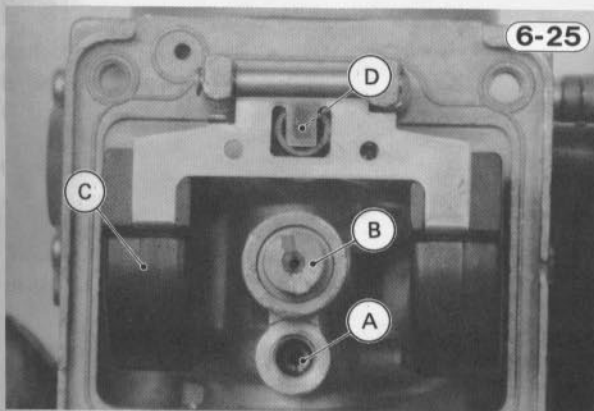

A. Pilot Jet      B. Main Jet      C. Float Valve Needle  
D. Float Valve Seat

- Using a starting punch, start the float pin (68), pull off the pin, and remove the float (67).

**CAUTION**

1. Be careful not to damage the float pin holder by hitting the holder instead of the pin.

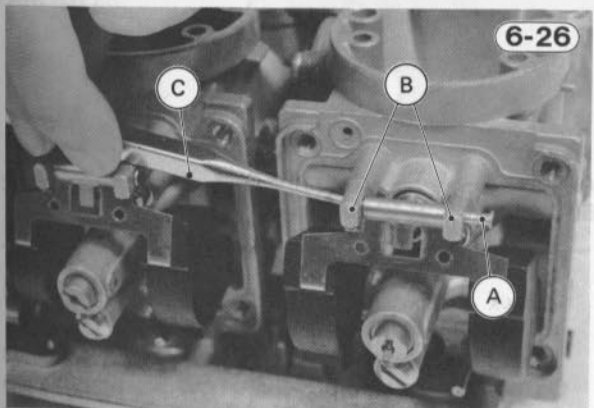

A. Pin      B. Pin Holder      C. Punch

- Remove the screw (49) and holding plate (65), and pull out the float valve assembly (valve needle (66), valve seat (64), O-ring (63), and filter (62)).

#### Top end:

- Remove the upper chamber cover screws (52) (4), and take off the cover (53) and spring (54).
- Pull off the vacuum piston and diaphragm assembly (59) with the jet needle (57) or (58).

**CAUTION**

1. During carburetor disassembly, be careful not to damage the diaphragm.

Never use a sharp edge to remove the diaphragm.

- Take out the spring seat (55) and jet needle.
- Remove the pilot screw (21), and take out the spring (23).

**NOTE:** 1. To remove the pilot screw (21) on the US model, punch and pry off the plug (19) with an owl or other suitable tools, turn in the pilot screw and count the number of turns until it seats fully but not tightly, and then remove the pilot screw, spring (23) and O-ring (20). This is to set the pilot screw on its original position when assembling.

- Separate the carburetors from the mounting plates. See the "Separation of Carburetors" paragraph.

- Unscrew the plunger cap (26), and pull out the starter plunger (24).

- For KZ/Z1000-J: Remove the screws (3), and remove the diaphragm cover (28) of the coasting enricher. The spring seat (40), spring (41), and diaphragm (25) will come out. Record their locations.

**NOTE:** 1. If more than one coasting enricher system is to be disassembled, mark and record their locations so they can be reinstalled in their original positions.

**CAUTION**

1. Do not turn the paint-locked screw on the diaphragm cover. Changing the position of the screw upsets the pre-load of the diaphragm spring (41), and could cause malfunctioning of the coasting enricher system.

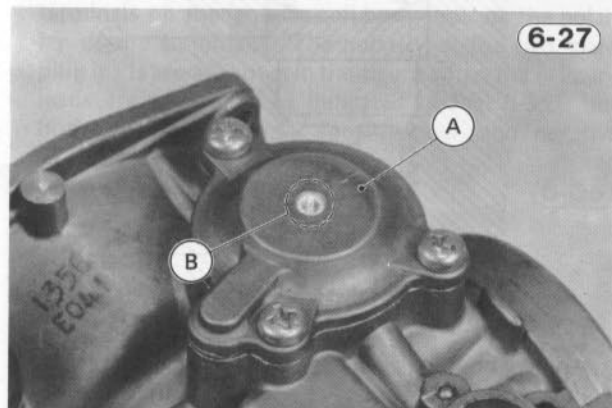

A. Cover      B. Do not turn this screw.

#### Carburetor Body Assembly (each carburetor)

**NOTE:** 1. Replace any O-ring, diaphragms, plastic plug, and gasket if damaged or deteriorated.

2. When installing the vacuum piston and diaphragm assembly, observe the following:

- Align the diaphragm tongue with the notch in the upper chamber cover mating surface, and fit the diaphragm sealing lip into its groove.

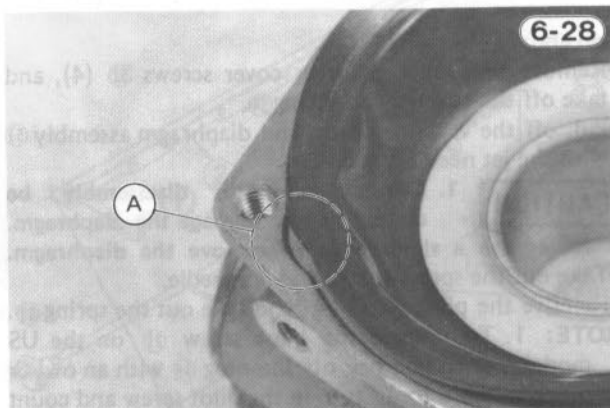

#### A. Align tongue with notch.

- After installing the upper chamber cover, check that the vacuum pistons slide up and down smoothly without binding in the carburetor bores.
- For the US model, install the pilot screw and plug as follows:
    - Turn in the pilot screw fully but not tightly, and then back it out the same number of turns counted during disassembly.
    - Install a new plug in the pilot screw hole, and apply a small amount of a bonding agent to the circumference of the plug to fix the plug.

#### CAUTION

- Do not apply too much bond on the plug to keep the pilot screw itself from being fixed.

#### Plug Installation (US model only)

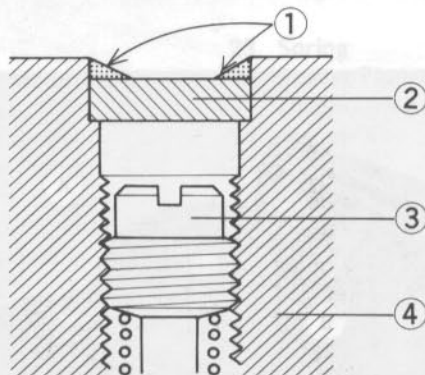

- Apply a bonding agent.
- Plug
- Pilot Screw
- Carburetor Body

#### Separation of Carburetors

- Remove the screws (2) and cable bracket (16).
- Remove the circlips (5) (4) off the choke shaft (3), and pull out the shaft. Two steel balls (8) and springs (9) will fall off the #2 and #3 carburetors.
- Remove the mounting screws (16), and remove the upper and lower mounting plates (2), (33).
- Separate the four carburetors.

#### Assembly after Carburetor Separation

- NOTE:** 1. The centerlines of the carburetor bores must be parallel both horizontally and vertically. If they are not, loosen the mounting screws just enough so that the carburetors are able to move, align them on a flat surface, and retighten the mounting screws.
- Choke shaft installation:
    - Apply grease to the shaft positioning springs and balls (2 ea), and put the spring and ball in this order into the #2 and #3 carburetors.
    - Install the spring (7) in each starter plunger lever (4).
    - Apply grease to the shaft hole in the carburetors, and insert the shaft through each plunger lever and spring while engaging the lever with the plunger groove.

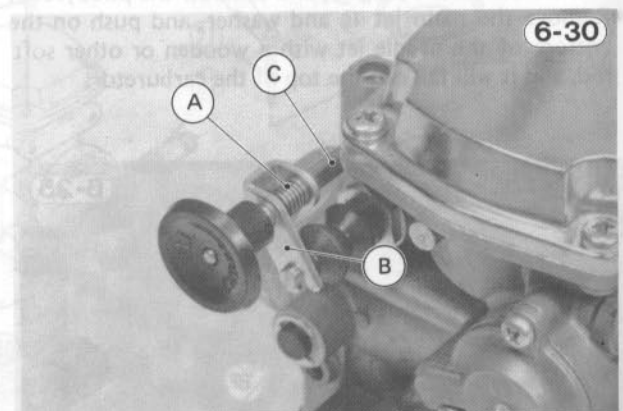

A. Spring

B. Plunger Lever

C. Shaft

- Install the circlips (4) on the choke shaft. The circlip must be on the left side of the spring seat.

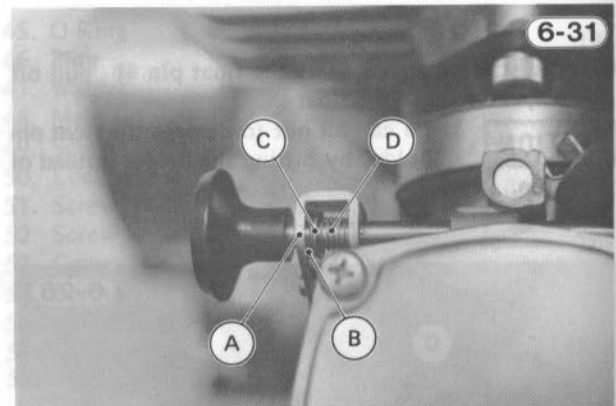
A. Lever  
B. CirclipC. Spring Seat  
D. Spring

- Check to see the choke shaft slides left to right smoothly without abnormal friction. The choke shaft has three stop positions:
  - On position — the fully-pulled-out position, the rod end of the #2 and #4 carburetors contacts against the #1 and #3 carburetors respectively.



Halfway position — the first click position in the choke return way.

Off position — the second click position in the choke return way, the plunger lever springs must be compressed a little to press securely the starter plungers against their seats in the carburetor bodies.

#### On Position:

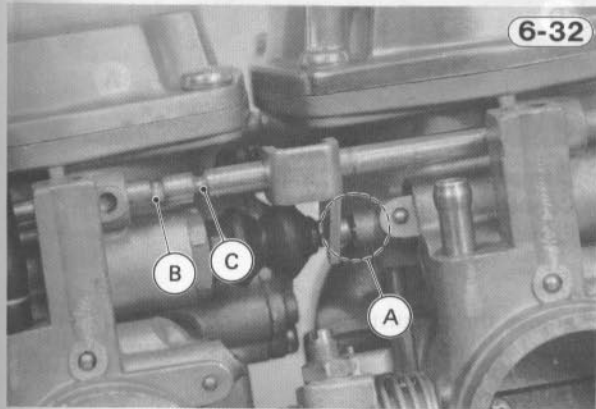

- A. Rod end contacts against carburetor body.  
 B. Halfway-Position Groove  
 C. Off-Position Groove

#### Off Position:

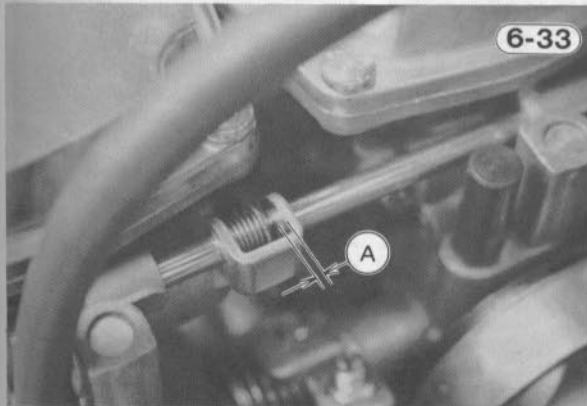

- A. Spring is compressed and there must be clearance.

#### CAUTION

1. Fuel mixture trouble could result if the plunger does not seat properly in its rest position after the choke knob is returned.

### VACUUM SWITCH VALVE (US model) IGNITION COILS

#### Removal:

##### Vacuum Switch Valve Removal (US model)

- Unlock and open the seat.
- Remove the fuel tank (Pg. 6-5).
- Slide the clamps out of place, and pull the air hose off each air suction valve cover.

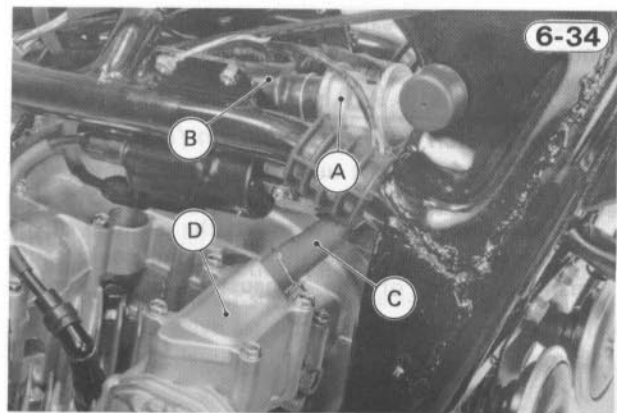

- A. Vacuum Switch Valve      C. Air Hose  
 B. Silencer                      D. Air suction valve cover

- Pull the air hose off the air cleaner housing.
- Slide the clamps out of place, and pull the vacuum hose off the # 1 and #4 carburetors.
- Pull the vacuum switch valve and the hoses free of the motorcycle.

#### Ignition Coil Removal (each side)

- Pull the spark plug caps off the spark plugs, and disconnect the primary leads off the ignition coil terminals.
- Remove the bolts (2) to take off the ignition coil.

#### Installation:

##### Ignition Coil Installation (each coil)

- NOTE.** 1. Install the ignition coil for the # 1 and # 4 cylinders (labeled with the numbers on the spark plug leads) on the left side, and for the # 2 and # 3 cylinders on the right side.
2. Connect the primary leads to the ignition coil terminals as follows:
    - Black and red leads → # 1 and # 4 ignition coil
    - Green and red leads → # 2 and # 3 ignition coil
  3. The “+” and “-” markings next to the primary terminals on the ignition coil body indicate the polarity of the terminals. The polarity of the two spark plug leads are as shown in the figure when the primary leads are connected as indicated in Fig. 6-35. But both the primary leads (positive red, and negative

#### Polarity of Ignition Coil

6-35

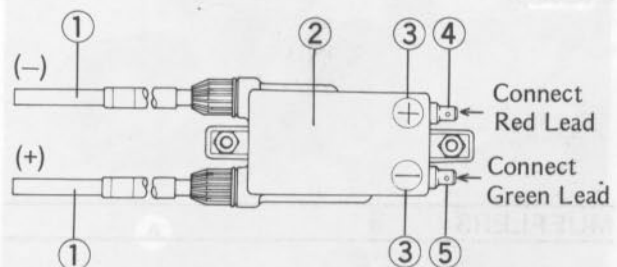

1. Spark Plug Lead
2. Ignition Coil
3. Marking
4. Primary + Terminal
5. Primary - Terminal

black and green) can be connected with either terminal on the ignition coil without changing the engine performance.

**Vacuum Switch Valve Installation (US model)**

**CAUTION**

1. Do not turn the paint-locked screw on the vacuum switch valve. Changing the position of the screw upsets the pre-load of the diaphragm spring inside the valve, and could cause malfunctioning of the exhaust emission control system.

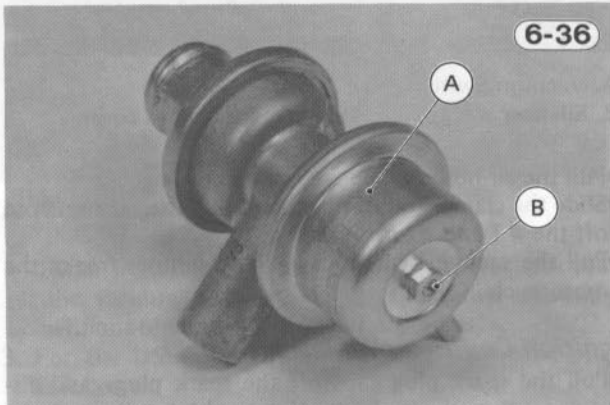

A. Valve B. Do not turn this screw.

**NOTE:** 1. Secure each hose end on the fitting with a clamp. Be sure that all hoses are routed without being flattened or kinked.

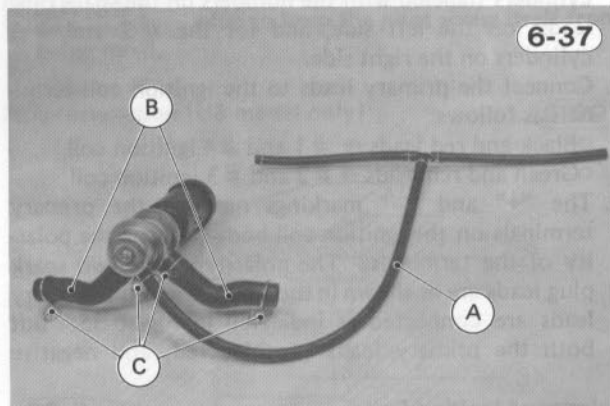

A. Vacuum Hoses B. Air Hoses  
C. Clamps

**MUFFLERS**

**Removal:**

**Muffler Removal**

•Loosen the clamps (2) that secure the muffler connecting pipe to the mufflers, and loosen # 2 and # 3 exhaust pipe clamps (2).

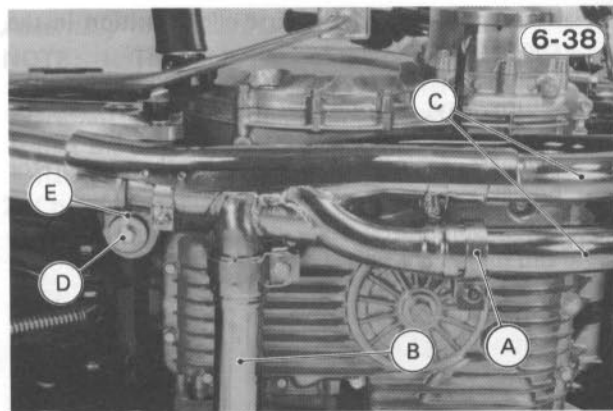

A. Clamps B. Connecting Pipe C. Exhaust Pipe  
D. Mounting Bolt E. Damper

•Remove the exhaust pipe holder nuts (8) and mounting bolts (4), and remove all mufflers, exhaust pipes, and connecting pipe.

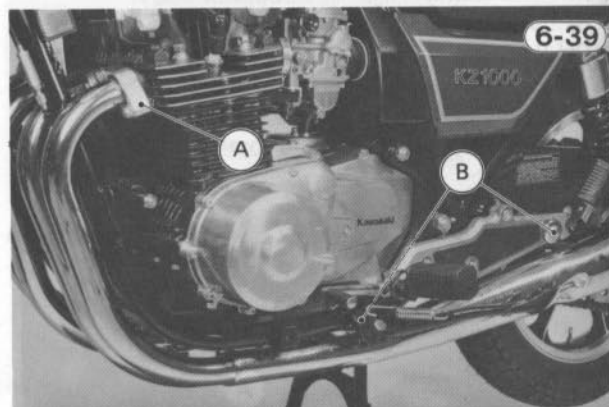

A. Exhaust Pipe Holder B. Mounting Bolts

**Muffler Installation**

**NOTE:** 1. There is an identification mark on the # 2 and # 3 exhaust pipes. Do not mix up those exhaust pipes.

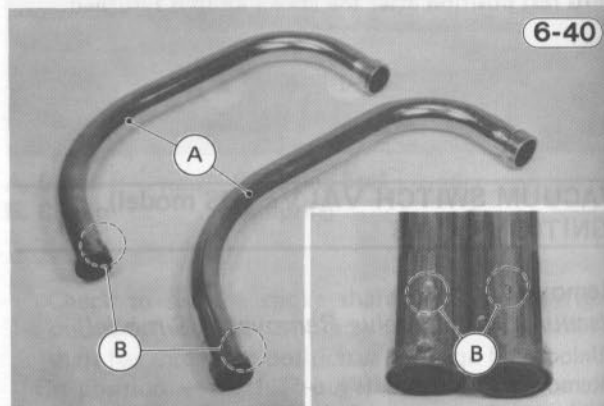

A. Exhaust Pipes B. Identification Marks

2. Install the rubber dampers (4) at the frame bottom as shown in the figure.

### Rubber Damper Installation

6-41

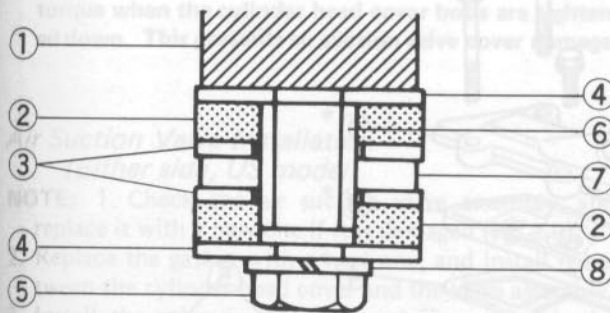

- |            |                    |
|------------|--------------------|
| 1. Frame   | 5. Bolt            |
| 2. Damper  | 6. Collar          |
| 3. Washers | 7. Muffler Bracket |
| 4. Washers | 8. Lockwasher      |

3. Check the gaskets at both ends of the connecting pipe and at the lower end of the #2 and #3 exhaust pipes for damage. Replace them if they are damaged.
4. Replace each gasket between the exhaust pipe upper end and the cylinder head with a new one.
5. Check to see that the gasket is between the exhaust pipe end and the cylinder, and install the split keepers in the position shown in the figure.

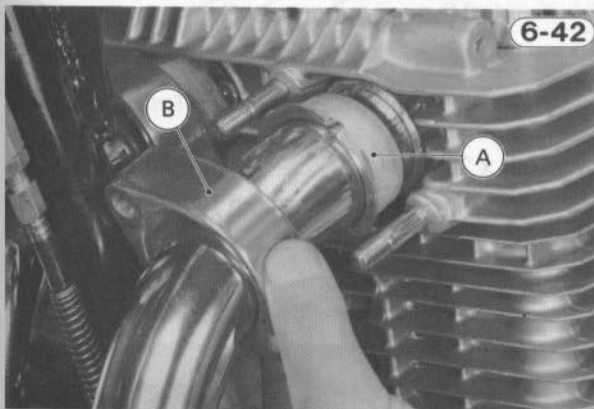

A. Split Keepers      B. Exhaust Pipe Holder

6. Tighten the muffler mounting bolts, nuts, and clamp bolts in the order and method indicated below.
- First, tighten all the bolts and nuts to snug fit.
  - Secondly, tighten the exhaust pipe holder nuts (8) evenly to avoid exhaust leaks.
  - Lastly, tighten the rest of the mounting bolts and clamp bolts securely.
7. Thoroughly warm up the engine, wait until the engine grows cold, and retighten all the clamp bolts.

## AIR SUCTION VALVES (US model) CYLINDER HEAD COVER UPPER CAMSHAFT CHAIN GUIDE

### Removal:

#### Air Suction Valve Removal (either side, US model)

- Remove the fuel tank (Pg. 6-5).
- Remove the air suction valve cover bolts (4), and lift the cover off the air suction valve assembly.
- Remove the valve assembly taking care not to damage the valve reeds and reed contact areas. Remove the gasket from the cylinder head cover.

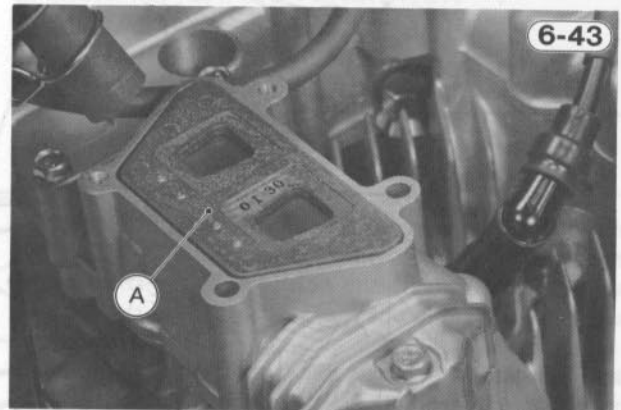

A. Valve Assembly

#### Cylinder Head Cover Removal

- Remove the fuel tank (Pg. 6-5).
- Pull the spark plug caps from the spark plugs.
- Remove the cylinder head cover bolts (24), and slip the cover off the cylinder head.

### CAUTION

1. For the US model, first loosen the air suction valve cover bolts (8), then remove the cylinder head cover bolts (24). This prevents air suction valve cover damage.

#### Upper Camshaft-Chain Guide Removal

- Remove the upper camshaft chain guide from the cylinder head cover.

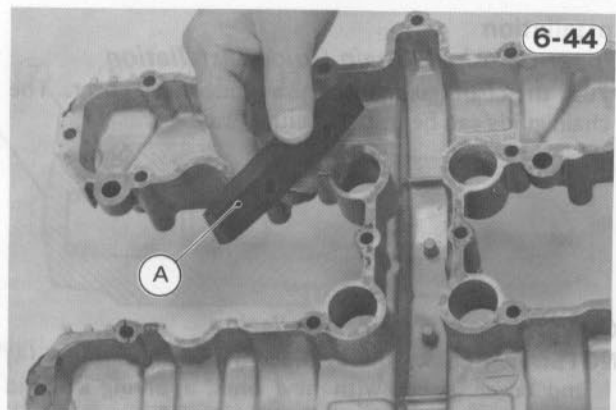

A. Upper Camshaft-Chain Guide

**Cylinder Head Cover, Cam Chain Guide,  
Air Suction Valve**

6-45

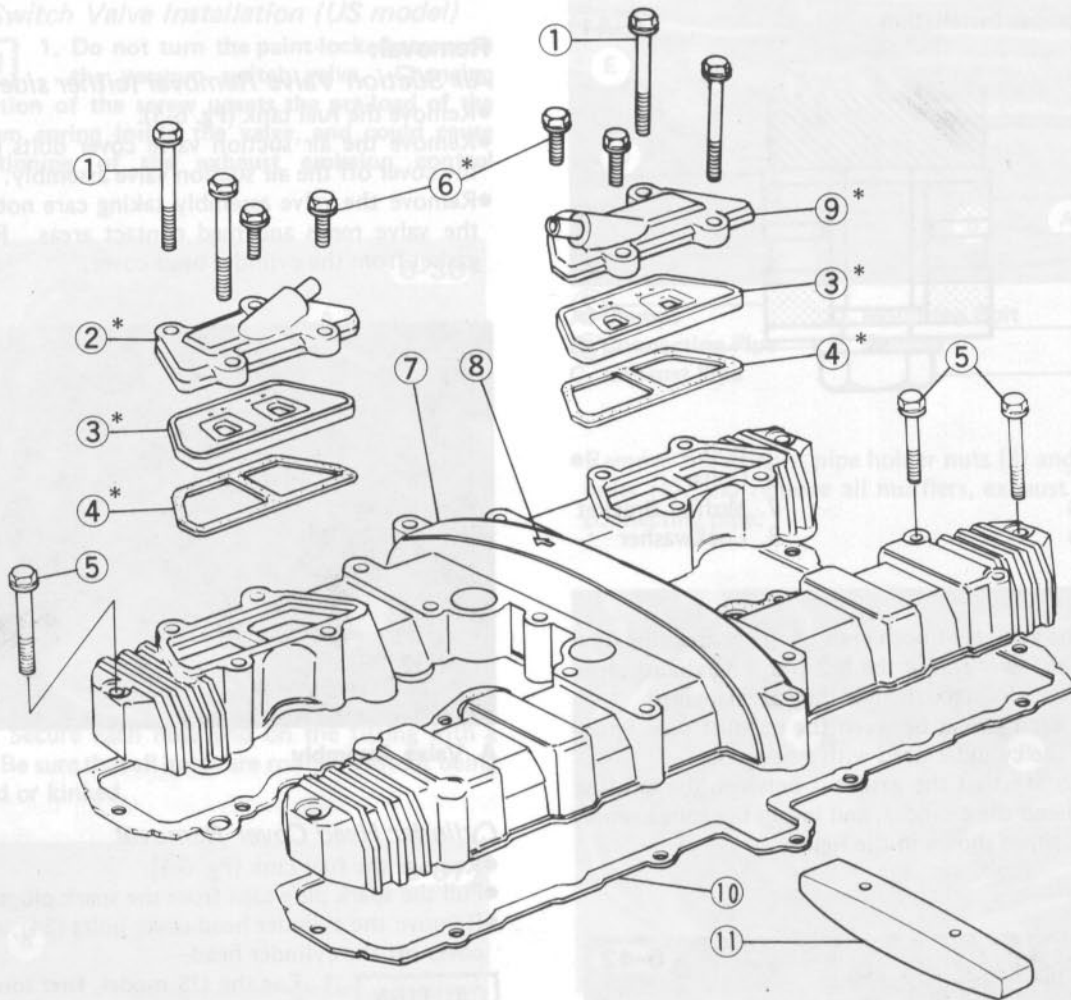

\*These parts are for US model only.

- 1. Cylinder Head/Air Suction Cover Bolt x 4
- \*2. Left Air Suction Valve Cover
- \*3. Valve Assembly
- \*4. Gasket

- 5. Head Cover Bolt x 20
- \*6. Air Suction Valve Cover Bolt x 4
- 7. Cylinder Head Cover
- 8. Arrow Mark

- \*9. Right Air Suction Valve Cover
- 10. Gasket
- 11. Chain Guide

### Installation

#### Upper Camshaft-Chain Guide Installation

- Push the chain guide into the cylinder head cover. The chain guide can be installed either way.

#### Cylinder Head Cover Installation

- NOTE:** 1. Replace the cylinder head rubber plugs (4) and cover gasket with new ones, applying a liquid gasket (silicone sealant) to the circumference of each rubber plug before installation.

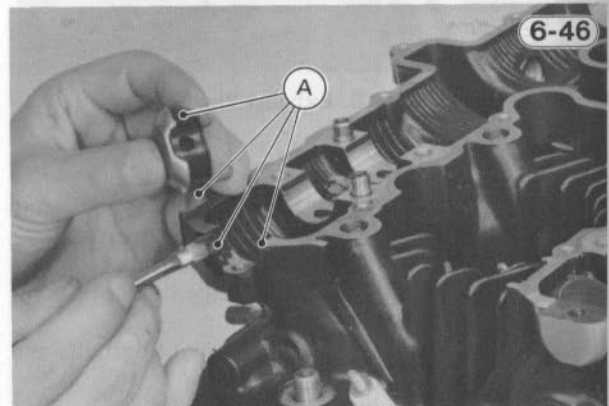

**A. Apply a liquid gasket (silicone sealant).**

6-46

2. Install the cylinder head cover on the cylinder head so that the arrow on the top of the cover points towards the front (Fig. 6-45).
3. Tighten the cylinder head cover bolts (24) to 1.0 kg-m (87 in-lbs) of torque.

**CAUTION** 1. For the US model, tighten also the air suction valve cover bolts to the same torque when the cylinder head cover bolts are tightened down. This prevents air suction valve cover damage.

**Air Suction Valve Installation**  
(Either side, US model)

- NOTE:** 1. Check the air suction valve assembly, and replace it with a new one if it is damaged (Pg. 2-9).
2. Replace the gasket with a new one, and install it between the cylinder head cover and the valve assembly.
  3. Install the valve so that the reeds face towards the cylinder head.

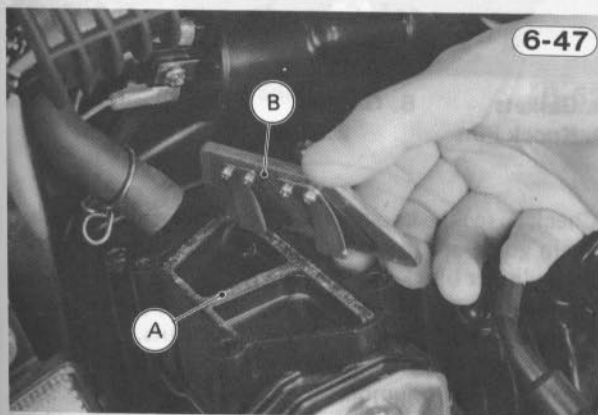

A. Gasket B. Valve Assembly

**Camshaft Chain Tensioner (Cross-wedge Type)**

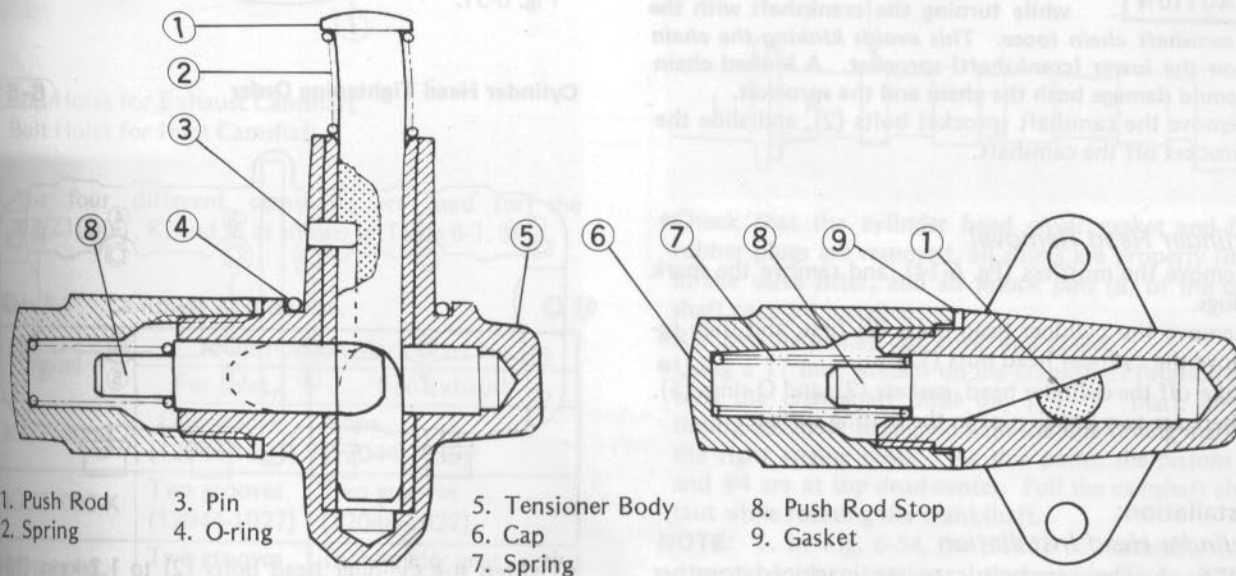

4. Tighten the cover bolts (4) to 1.0 kg-m (87 in-lbs) of torque.

**CAMSHAFT CHAIN TENSIONER**  
**CAMSHAFTS**  
**CAMSHAFT SPROCKETS**  
**CYLINDER HEAD**

**Removal:**

*Chain Tensioner Removal*

**CAUTION** This is a non-return type camshaft chain tensioner of which push rod does not return to its original position once it moves out to take up camshaft chain slack. Learn and observe all the rules listed below.

1. Before starting any disassembly operation that slackens the camshaft chain, remove the tensioner assembly from the engine.
2. When removing the chain tensioner, do not take out the mounting bolts only halfway. Retightening the mounting bolts from this position could damage the chain tensioner and the camshaft chain. Once the bolts are loosened, the tensioner must be removed and reset as described in the "Chain Tensioner Installation."

6-48

- Unlock the seat and open it.
- Remove the fuel tank and carburetors.
- Loosen the tensioner cap before tensioner removal for easier later tensioner resetting.
- Fully remove the tensioner mounting bolts (2), and pull out the camshaft chain tensioner and O-ring.

**CAUTION** 1. Do not turn over the crankshaft while the camshaft chain tensioner is removed. This could upset the camshaft chain timing, and damage the engine.

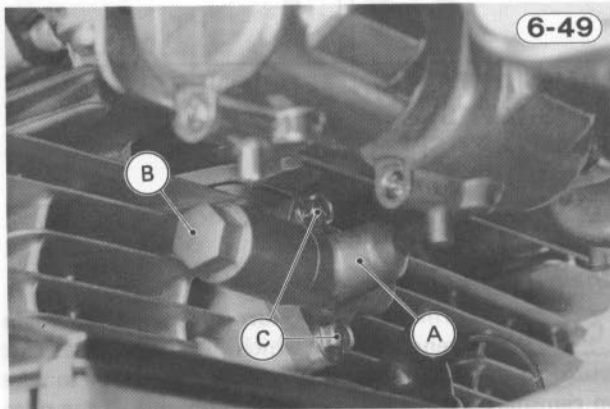

A. Chain Tensioner      C. Bolts  
B. Tensioner Cap

**Camshaft and Sprocket Removal**

- Remove the cylinder head cover (Pg. 6-15).
- Remove the camshaft cap bolts (16), and take off the camshaft caps (4). Mark the bearing inserts under each cap as to location. Any bearing inserts that are to be re-used must go back into their original locations. There are two knock pins at each cap base.
- Remove the camshafts. Use a screwdriver or wire to keep the chain from falling down into the cylinder block.

**CAUTION** 1. Always pull the camshaft chain taut while turning the crankshaft with the camshaft chain loose. This avoids kinking the chain on the lower (crankshaft) sprocket. A kinked chain could damage both the chain and the sprocket.

- Remove the camshaft sprocket bolts (2), and slide the sprocket off the camshaft.

**Cylinder Head Removal**

- Remove the mufflers (Pg. 6-14), and remove the spark plugs.
- Remove the cylinder head bolts (2) first, and then remove the cylinder head nuts (12).
- Take off the cylinder head, gaskets (2), and O-rings (5). There are two knock pins in the mating surface.

**Installation:**  
**Cylinder Head Installation**

**NOTE:** 1. The camshaft caps are machined together with cylinder head, so if a new cylinder head is

installed, use the caps that are supplied with the new cylinder head.

- Using compressed air, blow out any particles which may obstruct the oil passages.
- Install the new gaskets (2) and O-rings (5). Make sure that the gaskets are placed with the folded-over metal edges upward. There is no distinction between left and right gaskets.

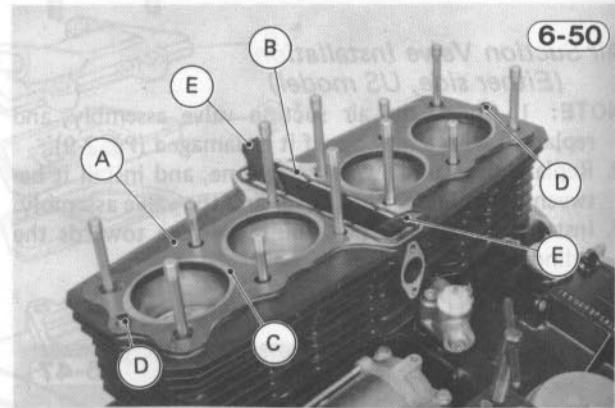

A. Gaskets      B. O-Rings      C. Folded-Over Metal  
D. Knock Pins      E. Chain Guide

- Check to see the knock pins (2) and rear lower camshaft chain guide are in place, and put the cylinder head on the cylinder block.
- Put the iron flat washers (8) and copper-plated flat washers (4) under the cylinder head nuts. The copper-plated washers should be located under the nuts indicated by the numbers 8, 9, 11, and 12 in Fig. 6-51.

**CAUTION** 1. Replace any damaged copper-plated flat washers with new ones to prevent oil leaks. These copper-plated washers work as gaskets.

- Tighten the cylinder head nuts first to about 2.5 kg-m (18.0 ft-lbs) of torque and then to 4.0 kg-m (29 ft-lbs) of torque, following the tightening sequence shown in Fig. 6-51.

**Cylinder Head Tightening Order**

6-51

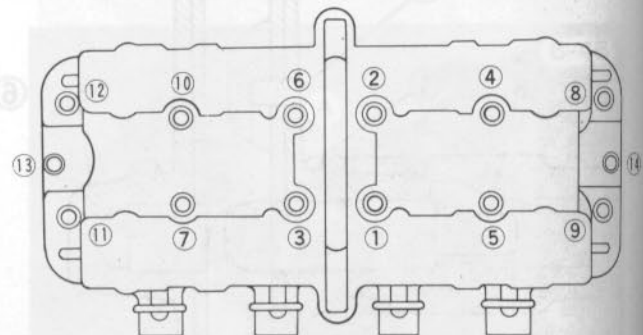

- Tighten the cylinder head bolts (2) to 1.2 kg-m (104 in-lbs) of torque.

- Install the spark plugs and tighten them to 2.8 kg-m (20 ft-lbs) of torque.
- Lift up the camshaft chain, and use a screwdriver to keep the chain from falling down into the cylinder block.
- Install the mufflers.

### Camshaft and Sprocket Installation

- Set the camshaft sprocket on the camshaft, aligning the bolt holes. Use the two of four sprocket-bolt holes for installation as shown. The marked side of the sprocket must face the notch on the shaft so that marking can be seen during timing the camshaft chain.
- Apply a non-permanent locking agent to the sprocket bolts (2) and install the bolts, tightening them to 1.5 kg-m (11.0 ft-lbs) of torque.

**NOTE:** 1. The inlet and exhaust camshaft sprockets are identical, and the same sprocket is used for all the KZ/Z1000-J, K, and M.

2. When installing the sprocket on the inlet camshaft, use the two holes in the square recesses; when on the exhaust camshaft, the two holes in the circle recesses.

### Bolt Holes in Camshaft Sprocket

6-52

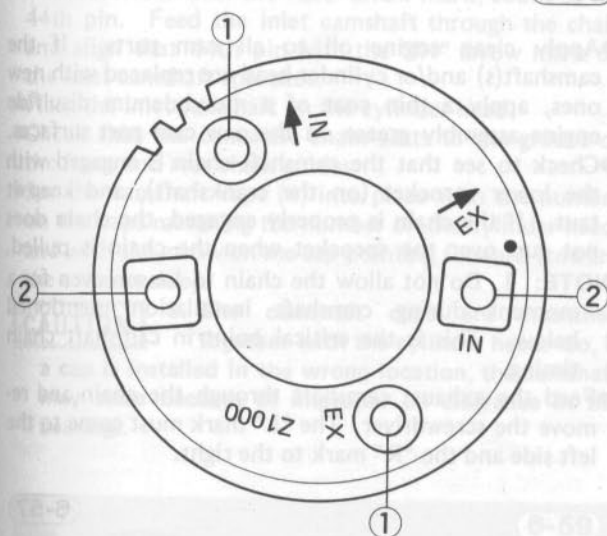

1. Bolt Holes for Exhaust Camshaft
2. Bolt Holes for Inlet Camshaft

3. The four different camshafts are used for the KZ/Z1000-J, K, and M as shown in Table 6-1.

Table 6-1 Camshaft Application

Model	Identification Mark (Part No.)	
	For Inlet	For Exhaust
KZ/Z1000-J	One groove (12044-1031)	None (12044-1036)
KZ/Z1000-K	Two grooves (12044-1027)	Two grooves (12044-1027)
KZ1000-M	Two grooves (12044-1027)	Tachometer gear teeth (12044-1039)

### Camshaft Identification Mark

6-53

- (1) Part Number: 12044-1027

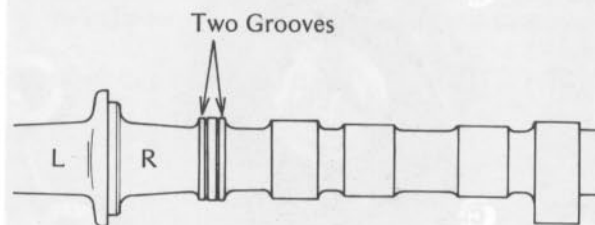

- (2) Part Number: 12044-1031

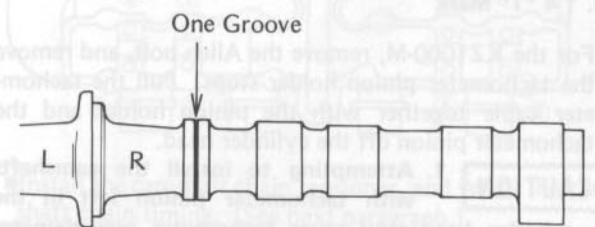

- (3) Part Number: 12044-1036

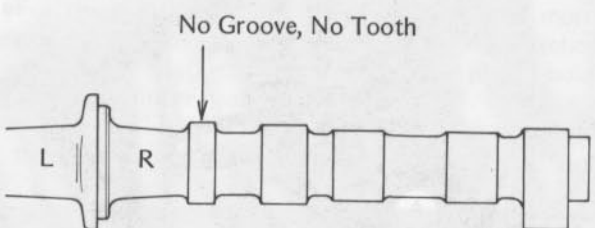

- (4) Part Number: 12044-1039

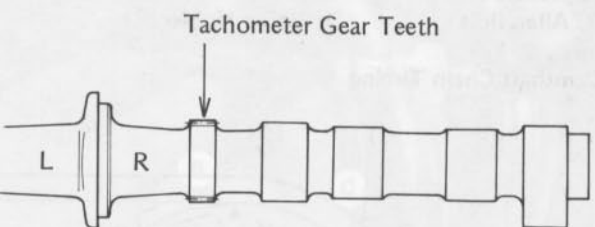

- Check that the cylinder head cover gasket and four rubber plugs are removed, all shims are properly fitted in the valve lifter, and all knock pins (8) of the camshaft caps are installed.
- Remove the pickup coil cover and gasket.
- Using a 17 mm wrench on the crankshaft rotation nut, turn the crankshaft until the 1 4 "T" mark on the timing advancer is aligned with the line timing mark on the right engine cover. At this point, the pistons #1 and #4 are at top dead center. Pull the camshaft chain taut while rotating the crankshaft.

**NOTE:** 1. In Fig. 6-54, the pickup coil assembly is removed for explanation. In actual procedure, pickup coil assembly removal is not necessary.

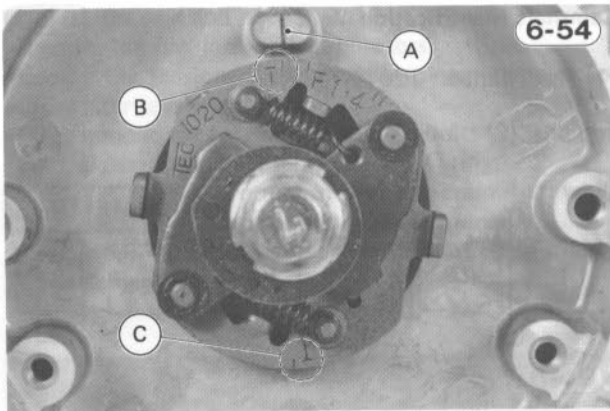

A. Timing Mark  
B. 14 "T" Mark  
C. 23 "T" Mark

•For the KZ1000-M, remove the Allen bolt, and remove the tachometer pinion holder stops. Pull the tachometer cable together with the pinion holder and the tachometer pinion off the cylinder head.

**CAUTION** 1. Attempting to install the camshafts with tachometer pinion left in the cylinder head may cause tachometer gear damage.

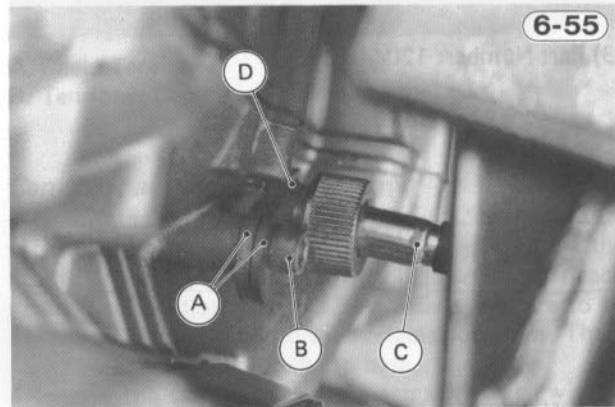

A. Holder Stops  
B. Allen Bolt  
C. Tachometer Cable  
D. Pinion Holder

Camshaft Chain Timing

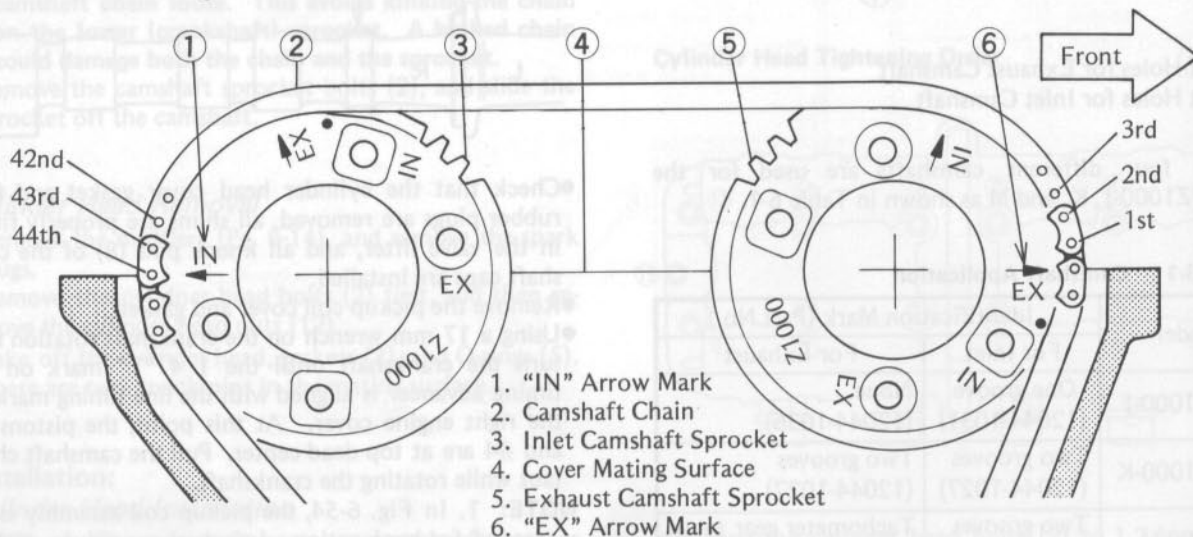

**NOTE:** 1. The 1 4 "T" mark on the automatic timing advancer must be aligned with the right engine cover mark.

•Check that all bearing inserts (16) are properly fitted into the cylinder head and camshaft caps, that is, the locating lug of each bearing insert must be matched with the slot in the bearing housings.

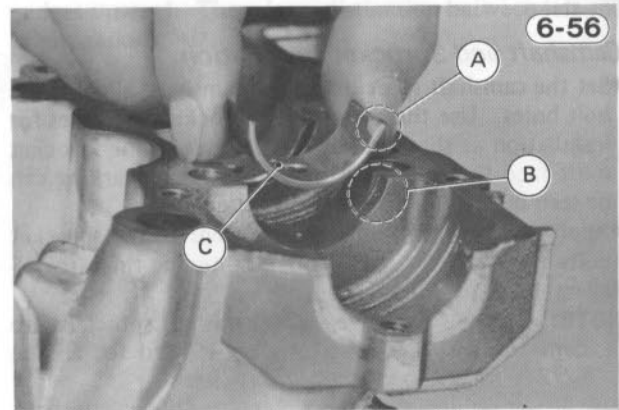

A. Locating Lug  
B. Slot  
C. Bearing Insert

•Apply clean engine oil to all cam parts. If the camshaft(s) and/or cylinder head are replaced with new ones, apply a thin coat of a molybdenum disulfide engine assembly grease on the new cam part surfaces.

•Check to see that the camshaft chain is engaged with the lower sprocket (on the crankshaft), and keep it taut. If the chain is properly engaged, the chain does not run over the sprocket when the chain is pulled.

**NOTE:** 1. Do not allow the chain to loosen even for a moment during camshaft installation mentioned below. This is the critical point in camshaft chain timing.

•Feed the exhaust camshaft through the chain and remove the screwdriver. The "L" mark must come to the left side and the "R" mark to the right.

6-57



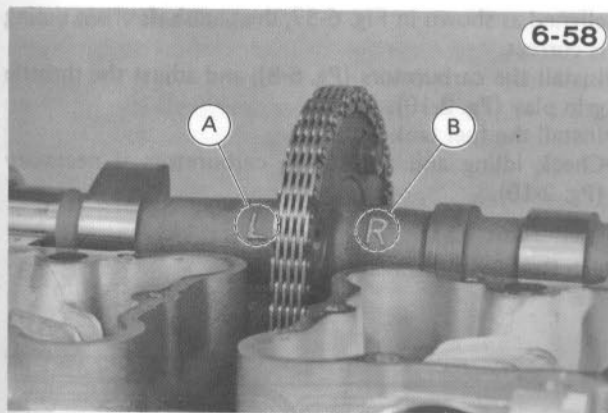

A. "L" Mark

B. "R" Mark

- Turn the exhaust camshaft so that the arrow adjoining the "EX" ("EX" arrow mark for short) mark on the sprocket is pointing to the front aligned with the cylinder head surface.
- Pull the chain taut and fit it onto the exhaust camshaft sprocket.
- Starting with the next chain-link pin above the one that coincides with the "EX" arrow mark, count to the 44th pin. Feed the inlet camshaft through the chain and align that 44th pin with the "IN" arrow mark on the inlet camshaft sprocket.
- Place the inlet camshaft on the cylinder head.
- Check that the camshaft chain seats in the groove of the front and rear chain guides.
- Set the camshaft caps (4) into place with the number on the caps matching the number on the cylinder head, and with the arrow on the cap pointing forward (toward the exhaust side).

**CAUTION** 1. The camshaft caps are machined together with the cylinder head. So, if a cap is installed in the wrong location, the camshaft may seize because of improper oil clearance in the bearings.

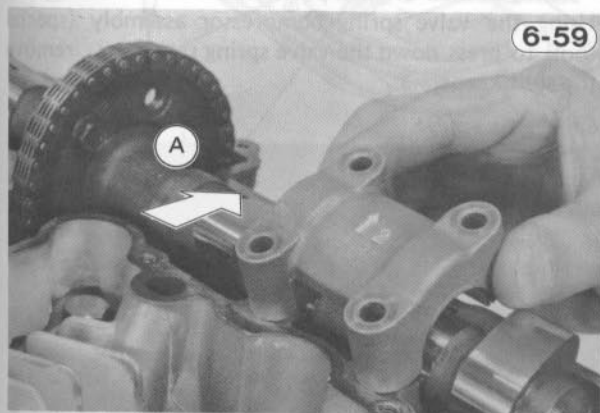

A. Forward

- Partially tighten the left inside camshaft cap bolts first, to seat the camshaft in place. Fully tighten all the bolts to 1.7 kg-m (12.0 ft-lbs) of torque, following the tightening sequence shown in the figure.

**CAUTION**

1. During tightening the camshaft cap bolts, check to see that the shims are not pushed out of the valve lifter by the cam lobes. If the bolts are tightened with the shim out of place, the cylinder head and the camshaft will be damaged.

## Camshaft Cap Tightening Order

6-60

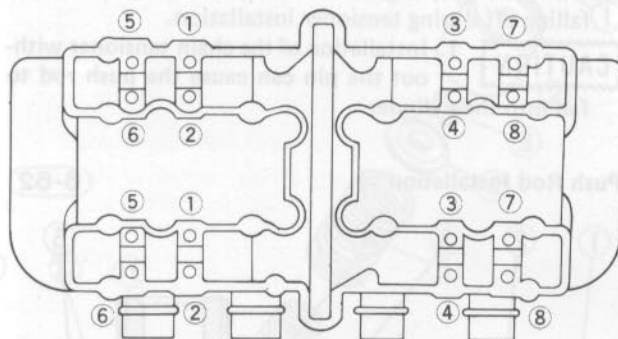

- Install the camshaft chain tensioner, and verify the camshaft chain timing. (See next paragraph.)

**NOTE:** 1. If a new camshaft, bearing inserts, cylinder head, valve, or valve lifter were installed; check valve clearance, and adjust if necessary.

- Install the cylinder head cover (Pg. 6-15).
- For the KZ1000-M, apply a small amount of molybdenum disulfide engine assembly grease to the tachometer pinion shaft, insert the pinion and pinion holder into the cylinder head.
- For the KZ1000-M, install the pinion holder stops, and tighten the holder stop Allen bolt.

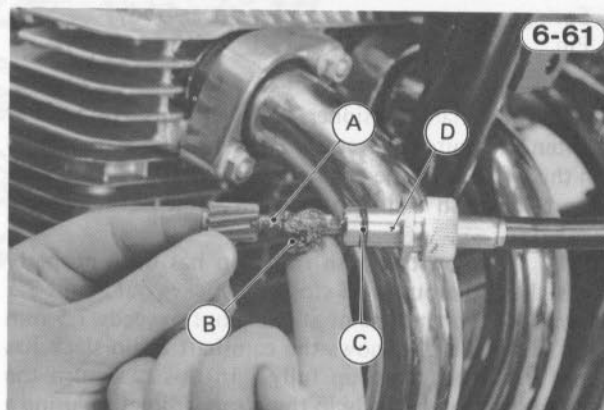

A. Pinion Shaft

B. Grease

C. O-Ring

D. Pinion Holder

**Chain Tensioner Installation**

- Remove the tensioner cap and gasket, and take the small spring and push rod stop out of the tensioner body.
- Remove the small pin from the tensioner body, and take the push rod and large spring out of the tensioner body.
- Using a high flash-point solvent, wash the tensioner parts clean of any dirt or grime, and apply a molybdenum disulfide engine assembly grease to the sliding surfaces of the tensioner parts.

**CAUTION**

1. The dirt or grime on the sliding surfaces of the tensioner parts could cause the tensioner to malfunction.

- Install the push rod spring on the push rod, and insert the push rod into the tensioner body.
- Compressing the spring, align the groove in the push rod with the hole in the tensioner body, and put the pin in the hole.

**NOTE:** 1. Apply a grease to the pin to prevent the pin falling off during tensioner installation.

**CAUTION**

1. Installation of the chain tensioner without the pin can cause the push rod to fall into the cylinder.

**Push Rod Installation**

6-62

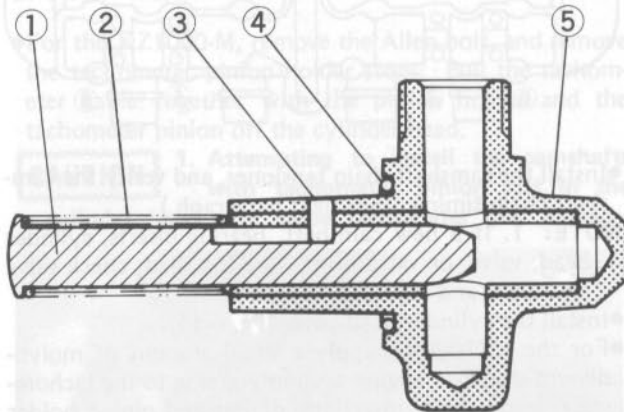

- |             |                   |
|-------------|-------------------|
| 1. Push Rod | 4. O-Ring         |
| 2. Spring   | 5. Tensioner Body |
| 3. Pin      |                   |

- Install the chain tensioner body with its O-ring, and tighten the bolts (2) evenly. The tensioner cap must be on the left side of the engine.
- Insert the push rod stop facing the flat surface downward.

**NOTE:** 1. When the push rod stop has been properly installed, the push rod stop end sticks out about 7.5 mm. If the amount of sticking-out exceeds 7.5 mm by very much, it shows the camshaft chain slack has not yet been taken up fully. In this case turn the crankshaft over slowly in the normal direction using a 17 mm wrench on the crankshaft.

- Install the push rod stop spring, gasket, and tensioner cap. Tighten the cap to 2.8 kg-m (20 ft-lbs) of torque.
- If the camshafts were removed, verify the camshaft chain timing using following two steps.
  - Check that, with the crankshaft positioned so #1 and #4 pistons are at TDC, the timing marks on the exhaust and inlet camshaft sprockets are aligned with the cylinder head surface (Fig. 6-57). If any one of the timing marks does not align with the cylinder head surface, remove and install again the camshafts.
  - Turn the crankshaft two turns in the normal direction until pistons #1 and #4 are at TDC, and re-check the camshaft chain timing. If all the timing marks are

aligned as shown in Fig. 6-57, the camshaft chain timing is correct.

- Install the carburetors (Pg. 6-8), and adjust the throttle grip play (Pg. 2-10).
- Install the fuel tank (Pg. 6-6).
- Check idling and adjust the carburetors if necessary (Pg. 2-10).

**Push Rod Stop Installation**

6-63

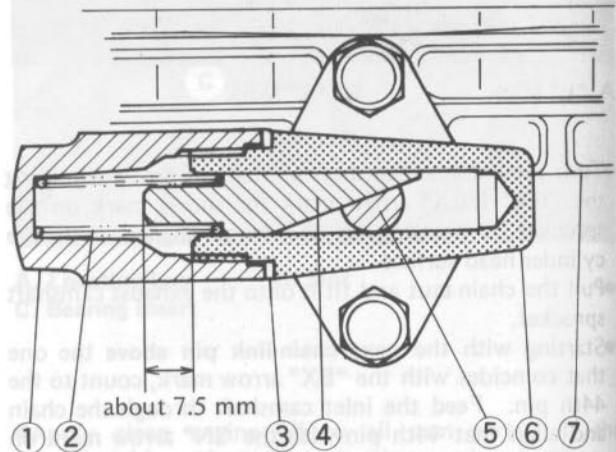

- |                  |                   |
|------------------|-------------------|
| 1. Tensioner Cap | 5. Push Rod       |
| 2. Spring        | 6. Tensioner Body |
| 3. Gasket        | 7. Cylinder Block |
| 4. Push Rod Stop |                   |

**Cylinder Head Disassembly and Assembly:****Cylinder Head Disassembly****(Each Valve, Valve Guide Removal)**

- Pull out the valve lifters (8) and shims (8). Record their locations.

**NOTE:** 1. If more than one valve is to be removed, mark and record their locations so they can be reinstalled in their original positions.

- Using the valve spring compressor assembly (special tool) to press down the valve spring retainer (4), remove the split keepers (3).

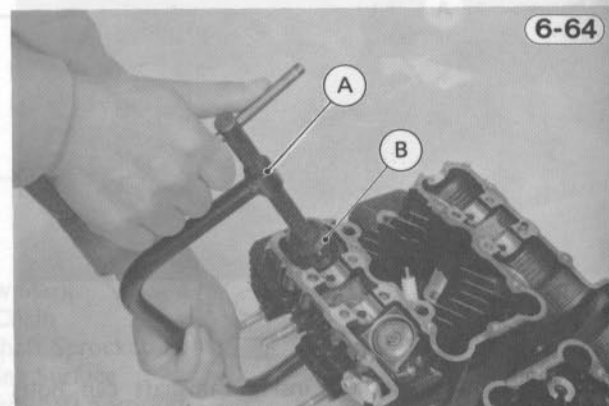

6-64

- A. Valve Spring Compressor: 57001-241**  
**B. Adapter: 57001-243**

## Valve and Valve Guide

**CAUTION**  
In an installation of this kind, the valve springs must be placed against the cylinder head.

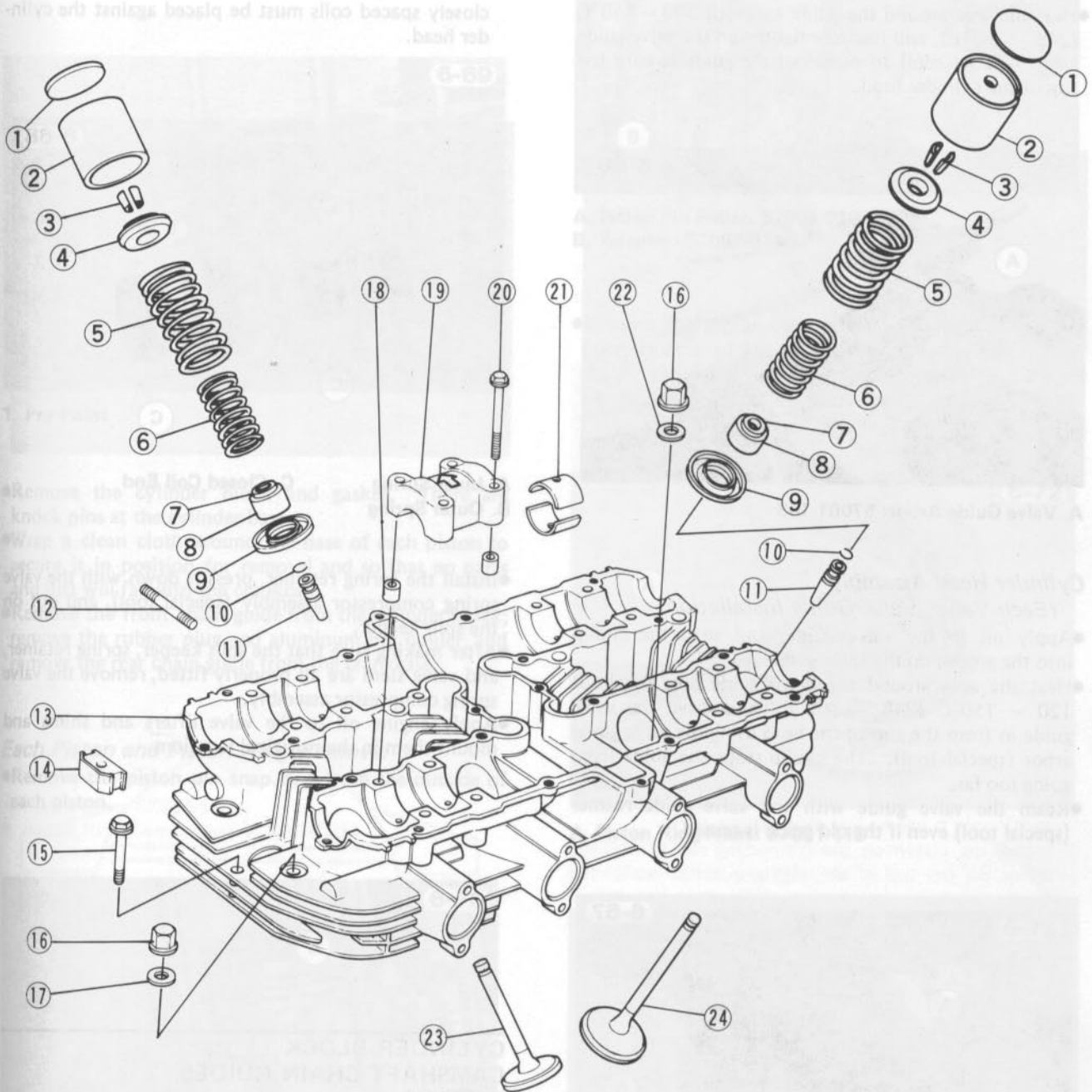

- |                          |                 |                          |                       |
|--------------------------|-----------------|--------------------------|-----------------------|
| 1. Valve Adjusting Shim  | 7. Clip         | 13. Cylinder Head        | 19. Camshaft Cap      |
| 2. Valve Lifter          | 8. Oil Seal     | 14. Rubber Plug          | 20. Camshaft Cap Bolt |
| 3. Split Keeper          | 9. Spring Seat  | 15. Cylinder Head Bolt   | 21. Bearing Insert    |
| 4. Valve Spring Retainer | 10. Circlip     | 16. Cylinder Head Nut    | 22. Washer            |
| 5. Outer Valve Spring    | 11. Valve Guide | 17. Copper-Plated Washer | 23. Exhaust Valve     |
| 6. Inner Valve Spring    | 12. Stud        | 18. Knock Pin            | 24. Inlet Valve       |

- Remove the tool, and then remove the spring retainer ④, outer spring ⑤, and inner spring ⑥.
- Push out the valve ⑫ or ⑭.
- Remove the clip ⑦ and pull off the oil seal ⑧ using a hook.
- Remove the spring seat ⑨.
- Heat the area around the guide to about 120 – 150°C (248 – 302°F), and hammer lightly on the valve guide arbor (special tool) to press out the guide toward the top of the cylinder head.

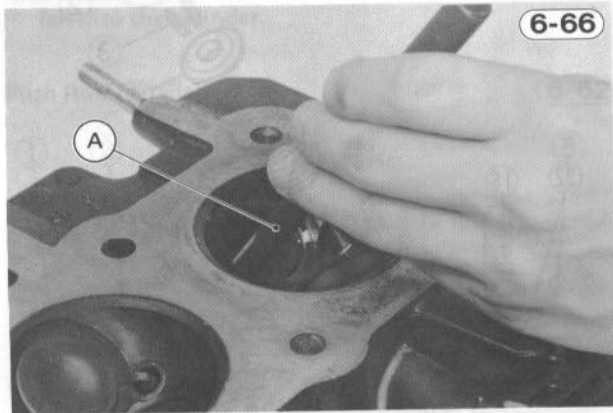

A. Valve Guide Arbor: 57001-163

### Cylinder Head Assembly (Each Valve, Valve Guide Installation)

- Apply oil to the valve guide, and snap the circlip into the groove on the valve guide.
- Heat the area around the valve guide hole to about 120 – 150°C (248 – 302°F), and drive the valve guide in from the top of the head using the valve guide arbor (special tool). The circlip stops the guide from going too far.
- Ream the valve guide with the valve guide reamer (special tool) even if the old guide is reused.

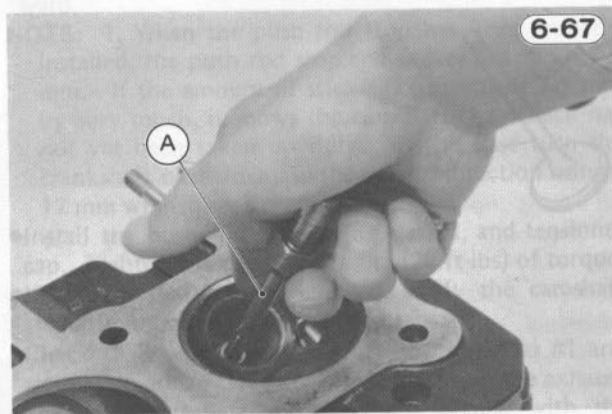

A. Valve guide Reamer: 57001-162

- Lap the valve to check that it is seating properly. If it is uneven, repair the valve seat.
- Install the spring seat, and push a new oil seal into place, and install its clip.

- Apply a thin coat of molybdenum disulfide engine assembly grease to the valve stem. Insert the valve, and install the outer and inner springs.

**NOTE:** 1. The inner and outer valve springs have the coils closer together at one end than at the other. In an installation of this kind, the end with the more closely spaced coils must be placed against the cylinder head.

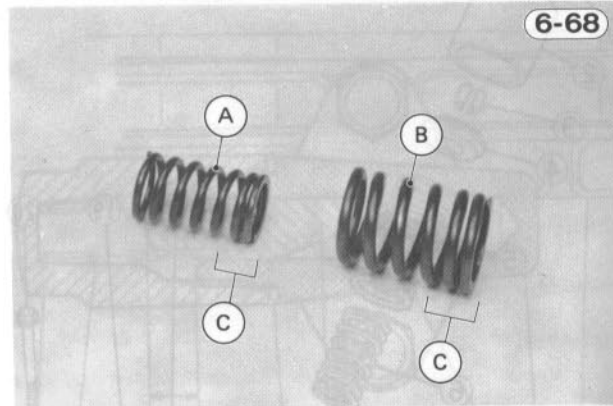

A. Inner Spring  
B. Outer Spring  
C. Closed Coil End

- Install the spring retainer, press it down with the valve spring compressor assembly (special tool), and put on the split keeper.
- After making sure that the split keeper, spring retainer, and valve stem are all properly fitted, remove the valve spring compressor assembly.
- Apply engine oil to the valve lifters and shims and mount them in their original locations.

---

## CYLINDER BLOCK CAMSHAFT CHAIN GUIDES PISTONS PISTON RINGS

---

### Removal:

#### Cylinder Block and Chain Guide Removal

- Remove the following parts.
  - Fuel tank (Pg. 6-6)
  - Carburetors (Pg. 6-8)
  - Camshaft chain tensioner (Pg. 6-17)
  - Camshafts and sprockets (Pg. 6-18)
  - Mufflers (Pg. 6-14)
  - Cylinder head (Pg. 6-18)

- With a wide screwdriver, pry at the gap in each side of the cylinder base to free the cylinder block from the crankcase.

**CAUTION** 1. Do not hammer on the screwdriver while it is in the pry point as engine damage could result.

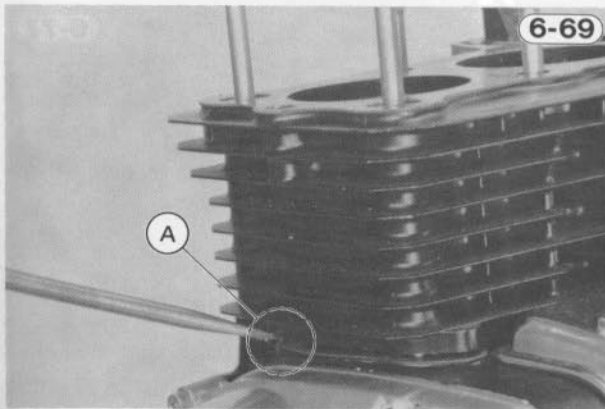

1. Pry Point

- Remove the cylinder block and gasket. There are knock pins at the cylinder base.
- Wrap a clean cloth around the base of each piston to secure it in position for removal and so that no parts and dirt will fall into the crankcase.
- Remove the front chain guide from the cylinder block; remove the rubber plug and aluminum pin holder, and remove the rear chain guide from the crankcase.

#### Each Piston and Piston Ring Removal

- Remove the piston pin snap ring from the outside of each piston.



A. Piston Pin Snap Ring

- Remove each piston by pushing its piston pin out the side that the snap ring was removed. Use the piston pin puller and adapter "C" (special tools) if necessary.

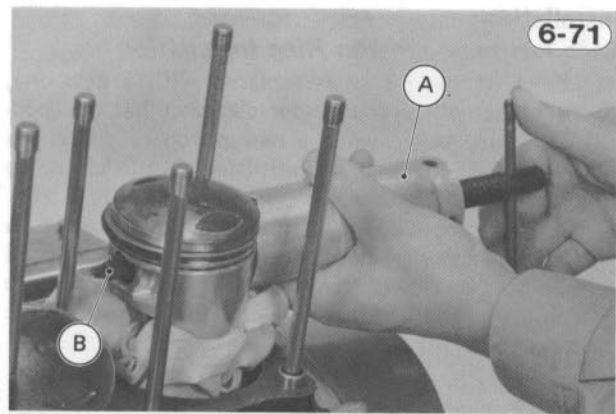

A. Piston Pin Puller: 57001-910  
B. Adapter: 57001-914

- Remove the top and second rings with the piston ring pliers (special tool). To remove a ring by hand, spread the ring opening with both thumbs, and then push up on the opposite side.

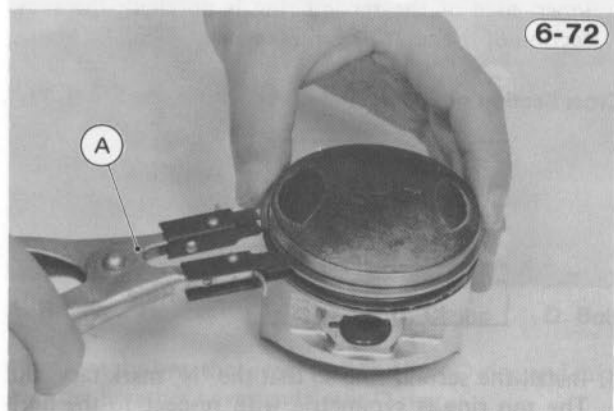

A. Piston Ring Pliers: 57001-115



A. First, spread opening. B. Secondly, push up.

- Remove the upper and lower piston ring steel rails, and then remove the expander.

**Installation:**

**Each Piston and Piston Ring Installation**

- NOTE:** 1. If the piston is replaced with a new one, check that piston-to-cylinder clearance has the specified value. Also, when a new piston or piston pin is installed, check that the piston to pin clearance has the specified value.
2. To install the oil ring, first install the expander so that the expander ends butt together, and then install the upper and lower steel rails. The two steel rails are identical. There is no "up" or "down" to the rails: they can be installed either way.

**Oil Ring Expander Installation**

6-74

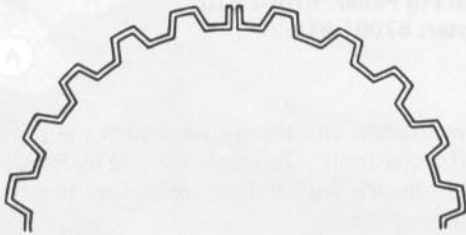

3. Do not mix up the second and top rings. The upper inner edge of the second ring is notched; the cross section of the top ring is rectangular.

**Cross Section of Piston Rings**

6-75

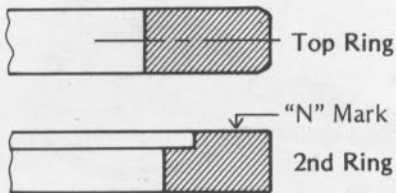

4. Install the second ring so that the "N" mark faces up. The top ring is symmetric with respect to the horizontal axis; it can be installed either way.
5. Install the piston on the connecting rod so that the arrow on the top of the piston points towards the front; fit a new piston pin snap ring into the side of the piston as removal weakens and deforms the snap ring. Check that a snap ring is installed on each side of piston.

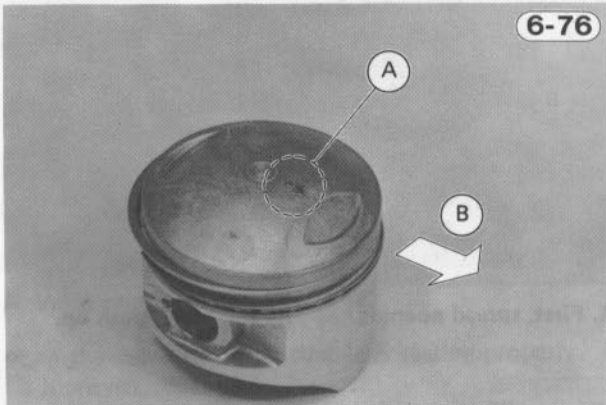

6-76

A. Arrow Mark B. Foreward

**Cylinder Block and Chain Guide Installation**

- NOTE:** 1. If the cylinder block is replaced with a new one, piston-to-cylinder clearance must be checked against the specified value.
2. Install the rubber plug for the rear camshaft-chain guide so that the "R" mark faces towards the rear.

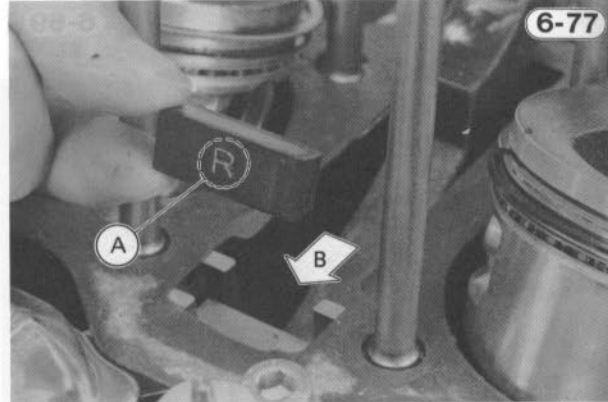

6-77

A. "R" Mark B. Rear

3. Position each piston ring so that the opening in the top and oil ring of each piston is facing forward, and the second ring opening faces the rear. The openings of the oil ring steel rails must be slipped to both direction about 30° from the opening of the expander.

**Oil Ring Opening**

6-78

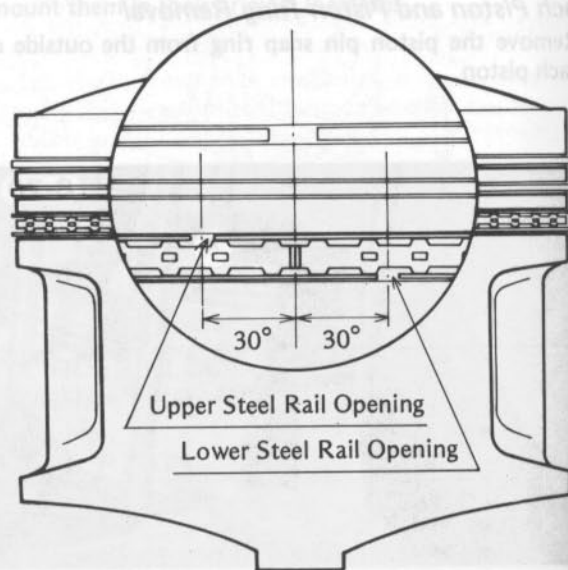

4. Apply engine oil to the piston rings and the cylinder inside surfaces. If the pistons and/or cylinder block are replaced, apply a thin coat of a molybdenum disulfide engine assembly grease on the new pistons and cylinder inside surfaces.

5. Using the piston bases (special tools) at the bottom of the pistons, hold the pistons level during cylinder installation. Compress the piston rings using a piston ring compressor (special tool: 57001-532 or 57001-1094).

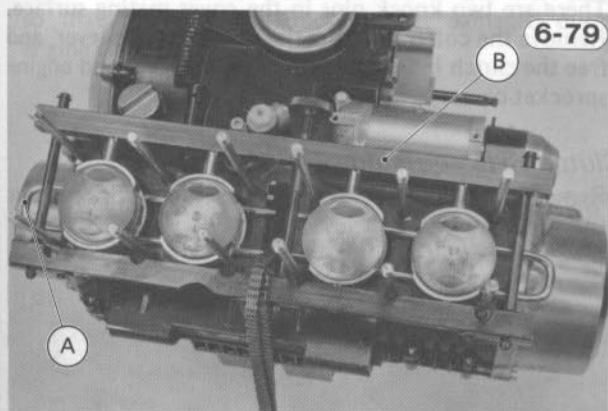

A. Piston Base: 57001-147  
B. Piston Ring Compressor: 57001-532

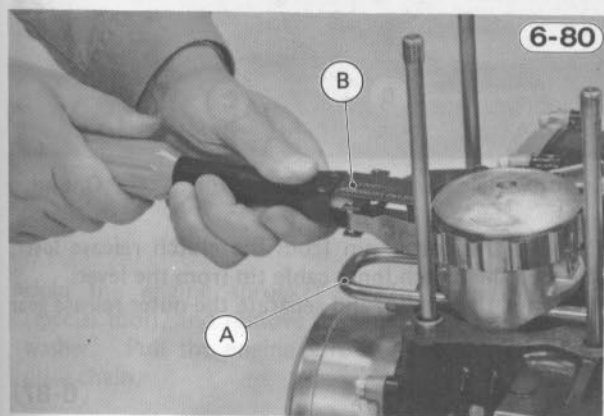

A. Piston Base: 57001-147  
B. Piston Ring Compressor: 57001-1094

6. Check the throttle grip play (Pg. 2-10) and carburetors (Pg. 2-10), and adjust them if necessary.

## OIL PRESSURE SWITCH BREATHER COVER

### Removal:

#### Oil Pressure Switch Removal

- Pull the oil pressure indicator switch lead off the switch.
- Unscrew the switch and remove the O-ring.

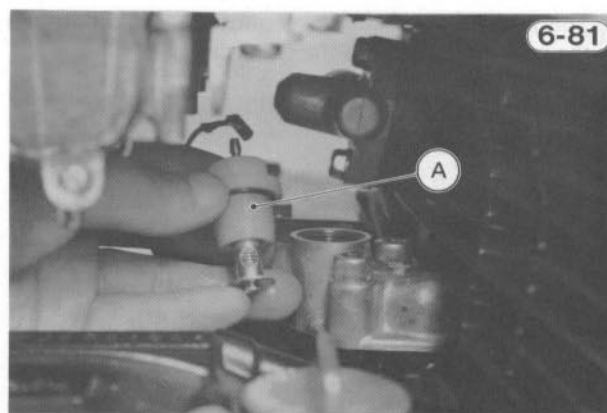

A. Oil Pressure Switch

#### Breather Cover Removal

- Slide the clamp out of place and remove the breather hose from the breather cover bolt.

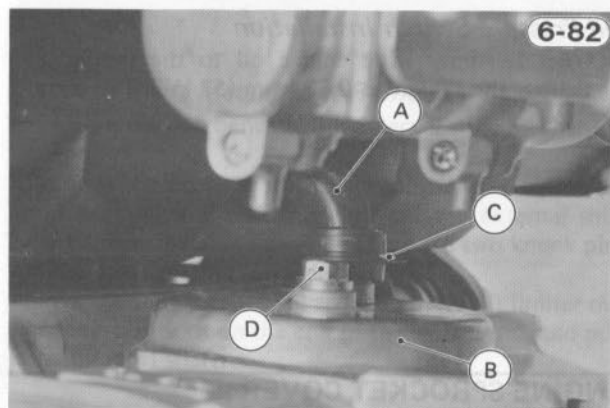

A. Breather Hose B. Cover C. Clamp D. Bolt

- Remove the breather cover bolt and bolt O-ring and take off the breather cover and cover O-ring.

### Installation:

#### Breather Cover Installation

- NOTE:** 1. Replace the breather cover O-ring, or breather cover bolt O-ring with a new one if deteriorated or damaged, and apply little engine oil to them before fitting them back in place.

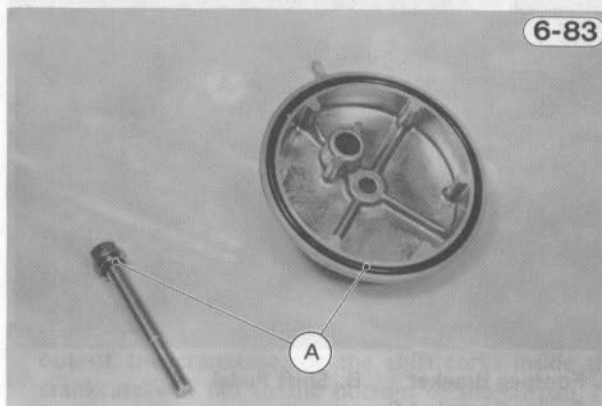

A. O-Rings

- 2. The projection of the cover must be fitted between the positioning pins on the crankcase.

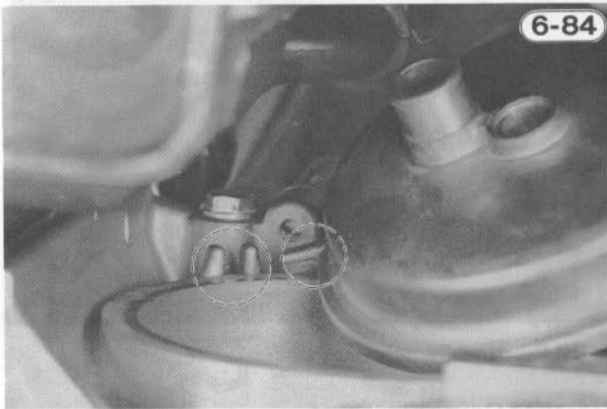

- 3. Tightening torque for the cover bolt is 0.60 kg-m (52 in-lbs).

**Oil Pressure Switch Installation**

**NOTE:** 1. Apply little engine oil to the O-ring, and tighten the switch to 0.60 kg-m (52 in-lbs) of torque.

**ENGINE SPROCKET COVER  
CLUTCH RELEASE  
ENGINE SPROCKET  
NEUTRAL SWITCH  
EXTERNAL SHIFT MECHANISM**

**Removal:**

**Engine Sprocket Cover Removal**

- Remove the bolts (3), and remove the left footpeg bracket.

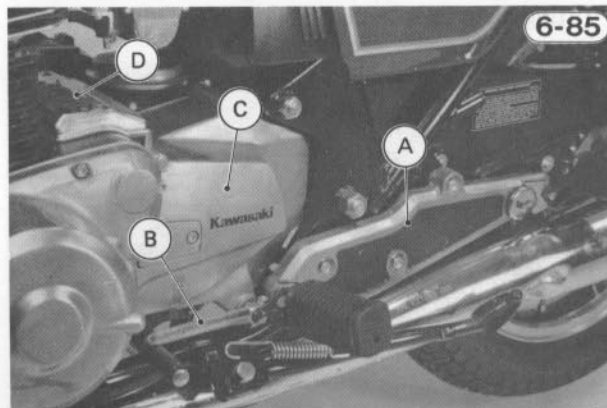

A. Footpeg Bracket B. Shift Pedal  
C. Engine Sprocket Cover  
D. Starter Motor Cover

- Take out the shift pedal bolt, and remove the shift pedal.
- Remove the starter motor cover and gasket. There is a flat washer on each mounting bolt.
- Remove the engine sprocket cover bolts and flat washers (4 ea), and pull the cover free from the crankcase. There are two knock pins in the cover mating surface.
- Remove the cotter pin from the clutch release lever, and free the clutch inner cable tip from the lever and engine sprocket cover.

**Clutch Release Removal**

- Remove the clutch release assembly mounting screws (2), and remove the release assembly.

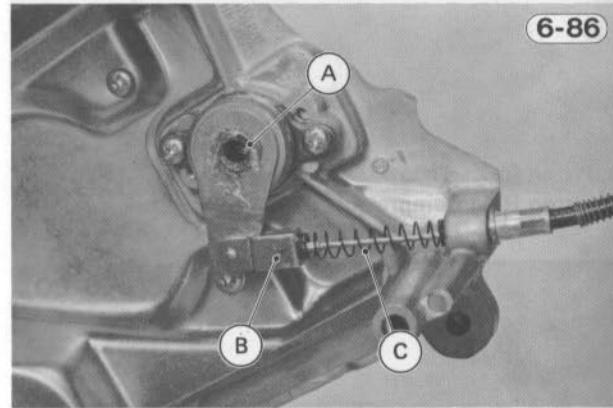

A. Clutch Release B. Cotter Pin C. Spring

- Remove the cotter pin from the clutch release lever, and free the clutch inner cable tip from the lever.
- Take out the circlip, and separate the outer release gear and the inner release gear.

**Clutch Release**

6-87

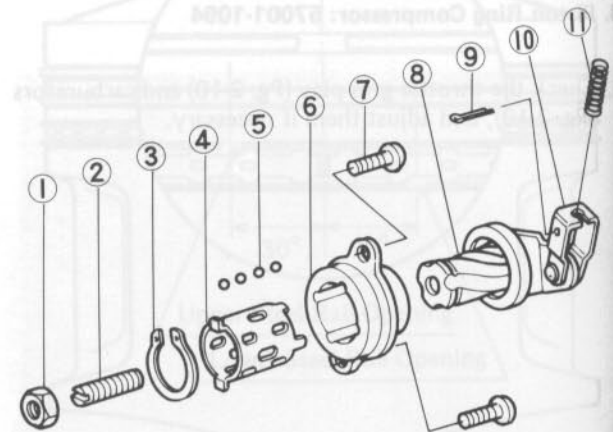

1. Locknut 7. Screw  
2. Adjusting Screw 8. Inner Release Gear  
3. Circlip 9. Cotter Pin  
4. Ball Retainer 10. Release Lever  
5. Steel Ball 11. Spring  
6. Outer Release Gear



### Engine Sprocket Removal

- Stand the motorcycle up on its center stand.
- Check that the transmission is in neutral.
- Slacken the drive chain by loosening the torque link nut, axle nut, and chain adjusting bolts.
- Take out the clutch push rod out of the drive shaft so that the push rod does not get damaged during engine sprocket removal.

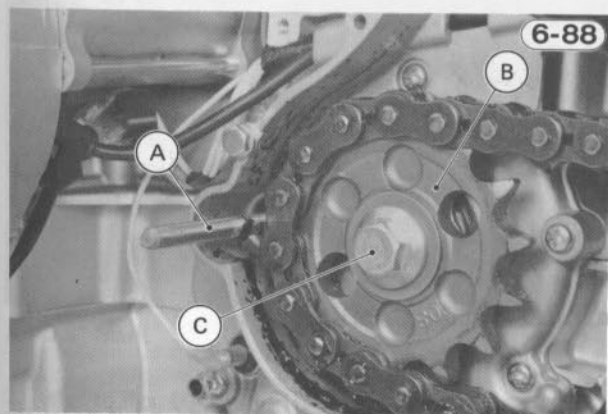

A. Push Rod  
B. Engine Sprocket  
C. Sprocket Bolt

- Hold the engine sprocket steady using the holder (special tool), and remove the engine sprocket bolt and washer. Pull the engine sprocket off along with the drive chain.

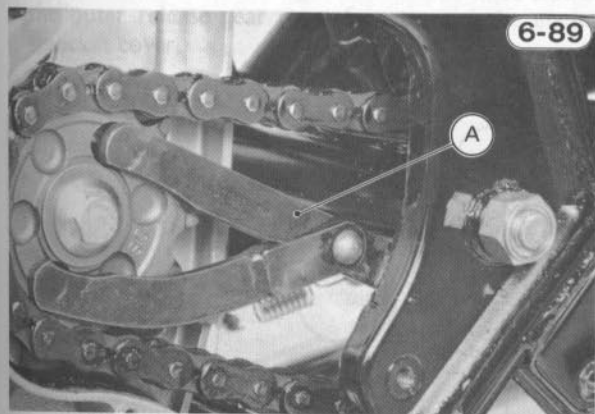

A. Holder: 57001-306

### Neutral Switch Removal

- Pull the lead off the neutral switch.

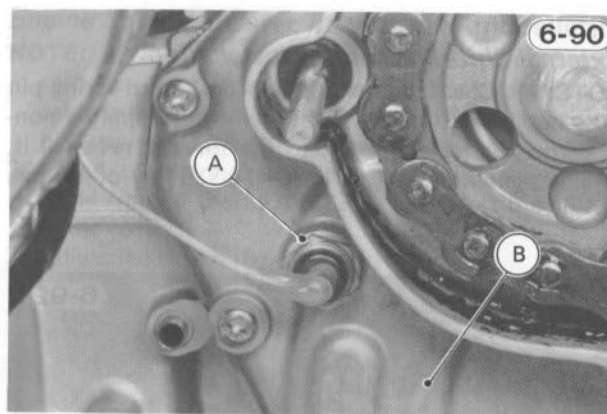

A. Neutral Switch  
B. External Shift Mechanism Cover

- Unscrew the neutral switch and gasket.

### External Shift Mechanism Removal

- Place an oil pan beneath the external shift mechanism cover.
- Remove the external shift mechanism cover screws (9) and bolt with a washer. Pull off the external shift mechanism cover and gasket. There are two knock pins in the cover mating surface.
- Move the shift mechanism arm and overshift limiter out of their positions on the end of the shift drum, and pull out the shift shaft.

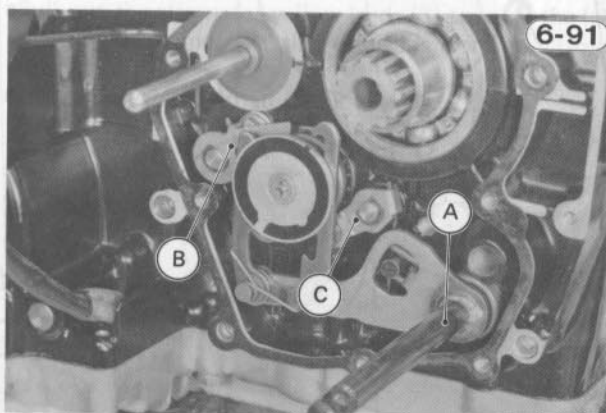

A. Shift Shaft  
B. Gear Positioning Lever  
C. Neutral Positioning Lever

- Remove the circlip from the end of the shift rods, and remove the gear positioning lever, neutral positioning lever, and their springs.

**NOTE:** 1. Do not pull the shift rod more than 40 mm out of the crankcase, or the shift forks inside the crankcase will fall to the bottom of the oil pan, requiring removal of the mufflers and oil pan to install them.

**Installation:**

**External Shift Mechanism Installation**

**NOTE:** 1. Check that the shift pedal return spring pin is not loose. If it is loose, remove it, apply a non-permanent locking agent to the threads, re-install it, and tighten it to 2.0 kg-m (14.5 ft-lbs) of torque.

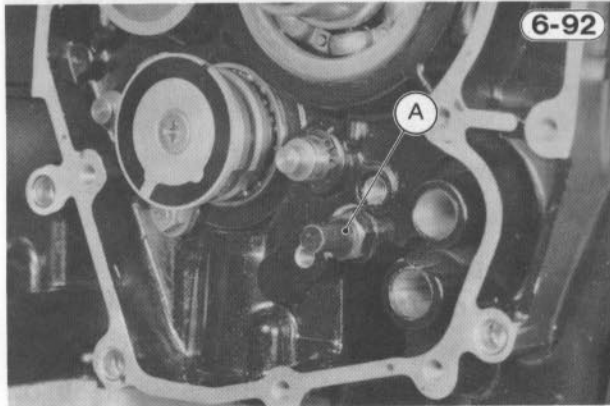

**A. Return Spring Pin**

2. Install the gear and neutral positioning levers, their springs, shift pedal and its return spring in the

**External Shift Mechanism Installation**

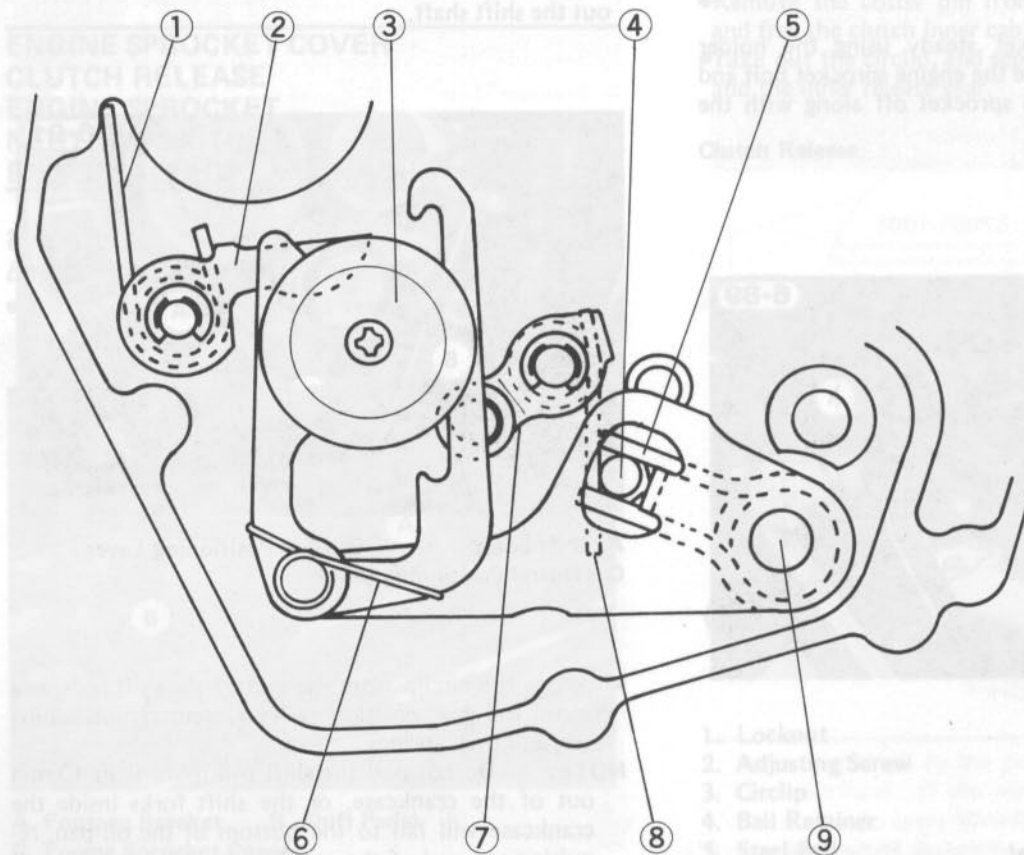

- 1. Spring
- 2. Gear Positioning Lever
- 3. Shift Drum
- 4. Return Spring Pin
- 5. Return Spring
- 6. Spring
- 7. Neutral Positioning Lever
- 8. Spring
- 9. Shift Shaft

positions indicated in Fig. 6-94. The neutral positioning lever spring must be between the hex head of the return spring pin and the shift pedal return spring.

3. When install the shift mechanism cover, insert the oil seal guide (special tool) in the external shift mechanism cover oil seal.

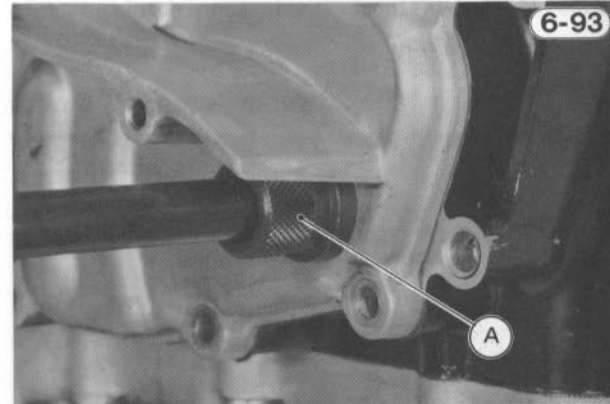

**A. Oil Seal Guide: 57001-266**

4. Check the engine oil level, and add oil if necessary (Pg. 2-4).

**A. Clutch Release      B. Cotter Pin** 6-94

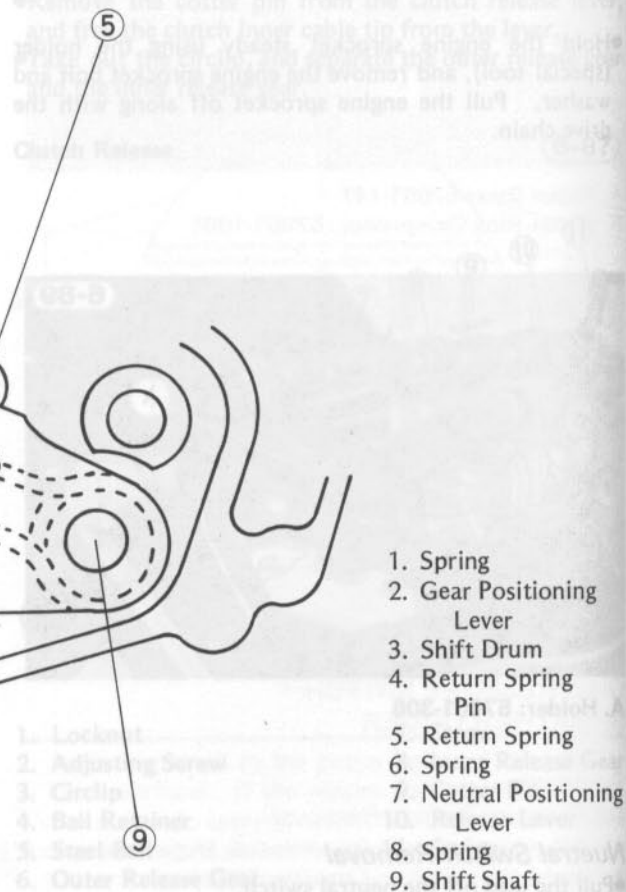

- 1. Locknut
- 2. Adjusting Screw
- 3. Circlip
- 4. Ball Retainer
- 5. Spring
- 6. Outer Release
- 7. Spring
- 8. Spring
- 9. Shift Shaft

### Neutral Switch Installation

**NOTE:** 1. Tightening torque for the neutral switch is 1.5 kg-m (11.0 ft-lbs).

### Engine Sprocket Installation

**NOTE:** 1. Install the engine sprocket with the "O.S." mark facing out.

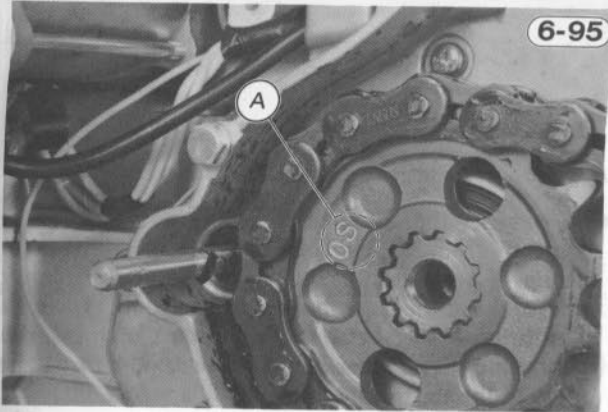

A. "O.S." Mark

2. Refer to Pgs. 10-52 and 10-52 for detailed information on engine sprocket installation.
3. Insert the clutch push rod into the drive shaft, applying thin coat of a molybdenum disulfide engine assembly grease to its surface.
4. Adjust the drive chain slack.

### Clutch Release Installation

**NOTE:** 1. Wash and clean the release balls and inner release gear with a high flash-point solvent. Dry and lubricate them with grease.

2. Fit the inner gear back into the outer release gear, release lever and the outer release gear must be positioned as shown in the figure. The machined side of the outer release gear must face toward the engine sprocket cover.

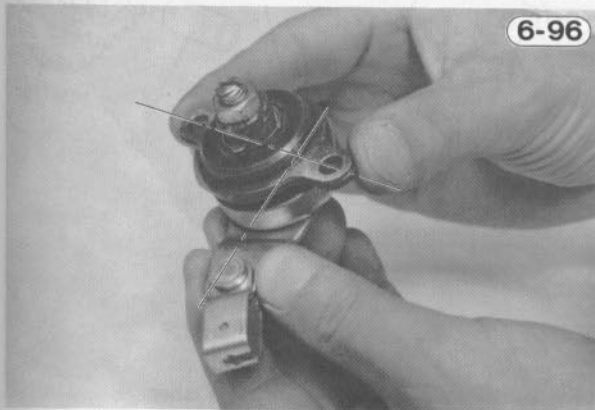

3. Apply a non-permanent locking agent to the clutch release mounting screws.

### Engine Sprocket Cover Installation

**NOTE:** 1. Run the clutch cable into the engine sprocket cover and spring, and fit the tip of the inner cable into the clutch release lever, using a new cotter pin, secure the cable tip to the release lever.

2. Install the engine sprocket cover using the oil seal guide (special tool: 57001-266) to protect the oil seal in the cover.

3. Adjust the clutch (Pg. 2-12).

---

## ALTERNATOR COVER ALTERNATOR STATOR ALTERNATOR ROTOR STARTER CLUTCH STARTER MOTOR

---

### Removal:

#### Alternator Cover and alternator Stator Removal

- Remove the engine sprocket cover as explained in engine sprocket cover removal (Pg. 6-28). The clutch cable need not be removed from the clutch release.
- Pull out the alternator yellow leads (3) towards the left side of the engine, releasing the leads from the clamps (2).
- Disconnect the alternator yellow leads (3).

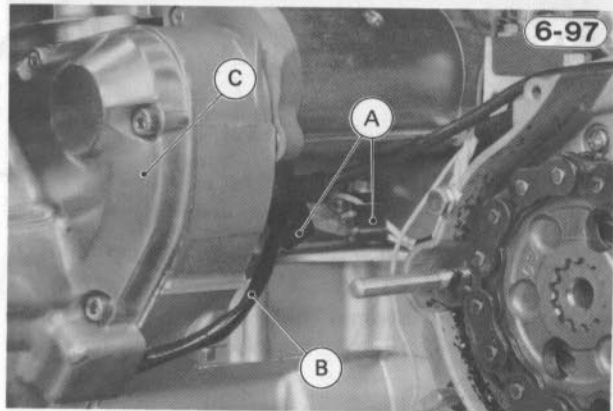

A. Clamps  
B. Alternator Leads  
C. Alternator Cover

- Place an oil pan beneath the alternator cover.
- Remove the alternator cover screws (8), and pull off the alternator cover and gasket. There are two knock pins in the cover mating surface.

- Remove the screws and lockwashers (2 ea) and take off the lead holding plate.

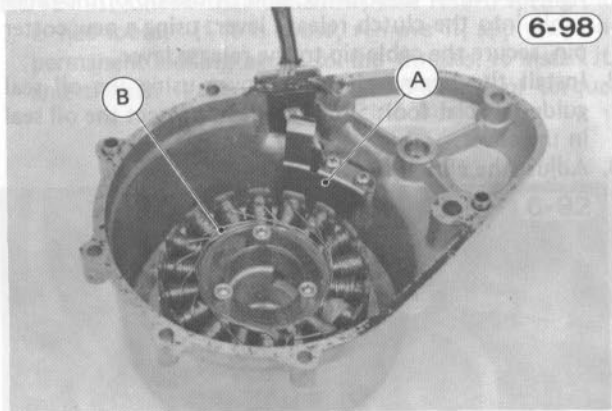

6-98

A. Holding Plate B. Alternator Stator

- Remove the stator Allen bolts (12) (3), and pull the stator (11) and grommet out of the cover.

**Alternator Rotor and Starter Clutch Removal**

- Hold the alternator rotor steady with the rotor holder (special tool), and remove the rotor bolt.

**Alternator, Starter Clutch**

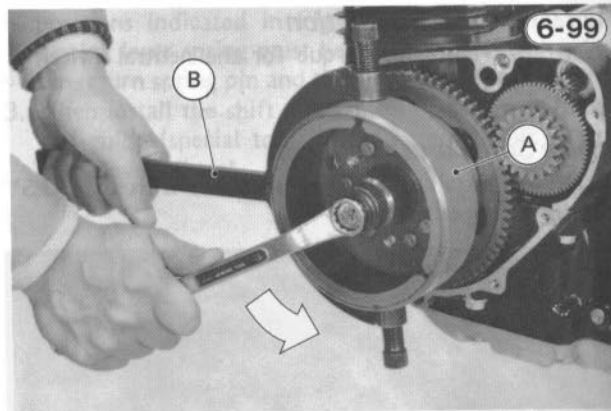

6-99

A. Alternator Rotor B. Rotor Holder: 57001-308

- To remove the alternator rotor and starter clutch assembly from the crankshaft, insert the rotor puller adapter (special tool 57001-1151) in the crankshaft hole, and use the rotor puller (special tool). There is a thin thrust washer between the starter clutch gear hub and the alternator rotor. The rubber damper may come out with the starter clutch gear.

**CAUTION** 1. If the rotor is difficult to remove and a hammer is used, turn the puller shaft by hand or using the wrench on it while tapping the head of the puller shaft with a hammer. Do not

6-100

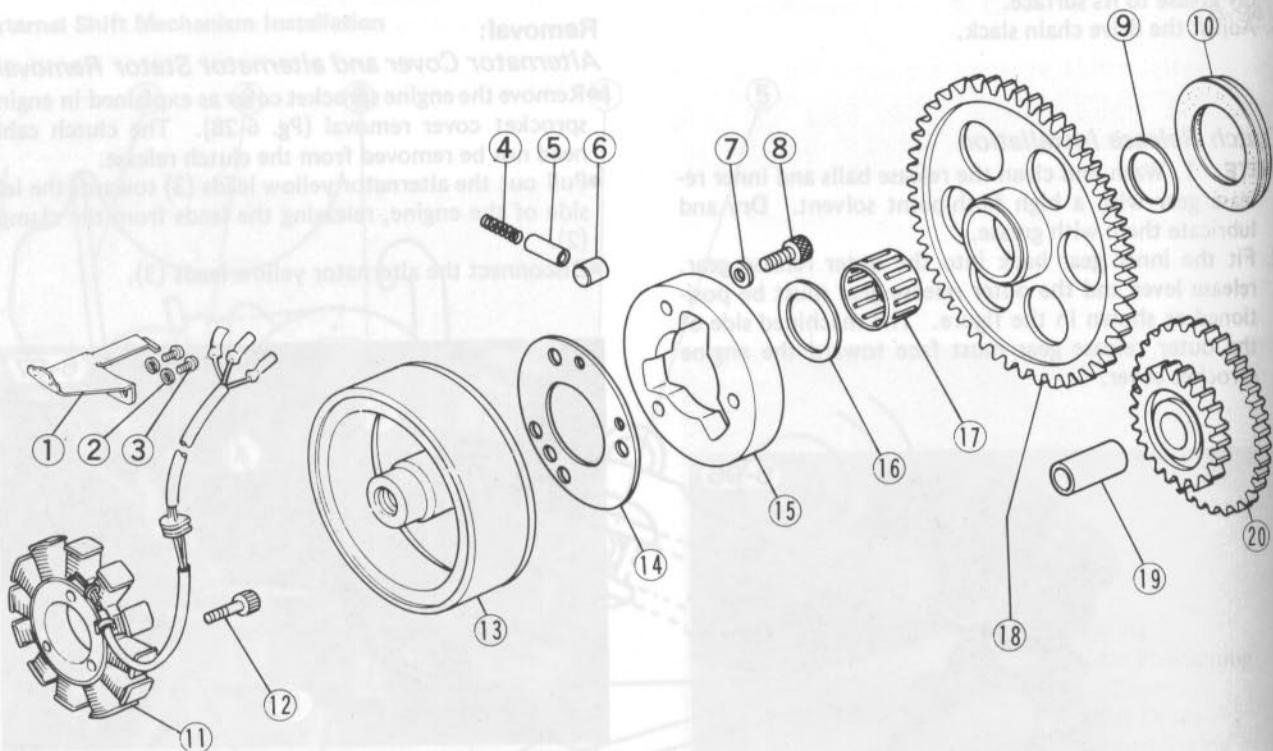

- |                       |                        |                         |
|-----------------------|------------------------|-------------------------|
| 1. Lead Holding Plate | 8. Allen Bolt          | 14. Steel Plate         |
| 2. Lockwasher         | 9. Thick Thrust Washer | 15. Starter Clutch      |
| 3. Screw              | 10. Rubber Damper      | 16. Thin Thrust Washer  |
| 4. Spring             | 11. Alternator Stator  | 17. Needle Bearing      |
| 5. Spring Cap         | 12. Allen Bolt         | 18. Starter Clutch Gear |
| 6. Roller             | 13. Alternator Rotor   | 19. Gear Shaft          |
| 7. Washer             |                        | 20. Reduction Gear      |

attempt to strike the grab bar or the alternator rotor itself. Striking the bar or the rotor can cause the bar to bend or the magnets to lose their magnetism.

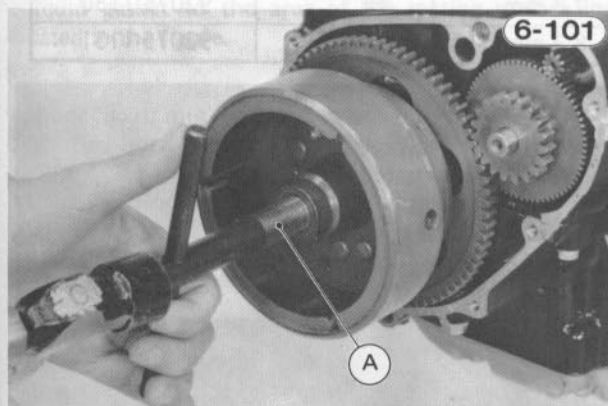

A. Rotor Puller: 57001-254 or 57001-1099

Remove the rollers, springs, and spring caps (3 ea) from the starter clutch.

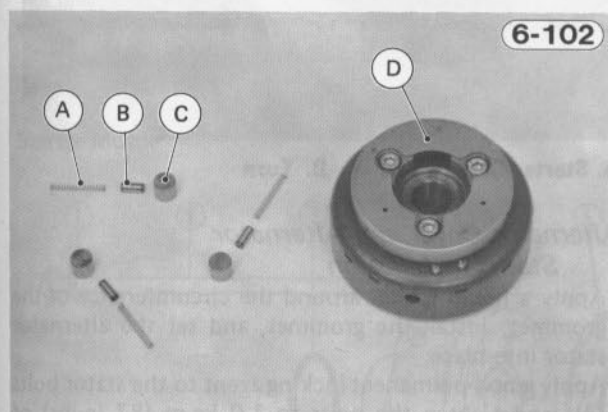

A. Spring B. Spring Cap C. Roller D. Starter Clutch

Holding the rotor steady with the rotor holder (special tool), remove the Allen bolts (3) to separate the rotor and starter clutch.

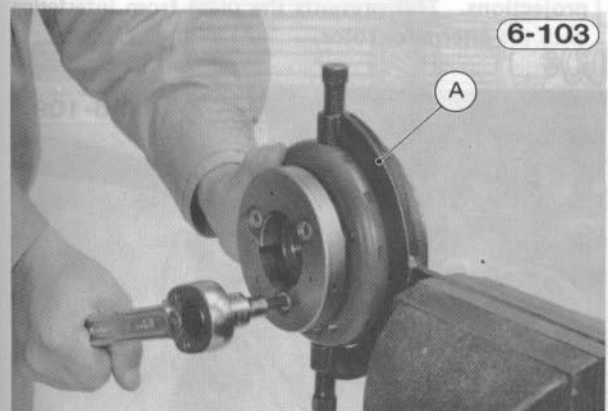

A. Holder: 57001-308

Remove the steel plate from the rotor.

### Starter Motor Removal

- Remove the fuel tank (Pg. 6-5), and carburetors (Pg. 6-8).
- Remove the camshaft chain tensioner cap, and pull out the spring and push rod stop.
- Remove the shaft and remove the starter motor reduction gear.

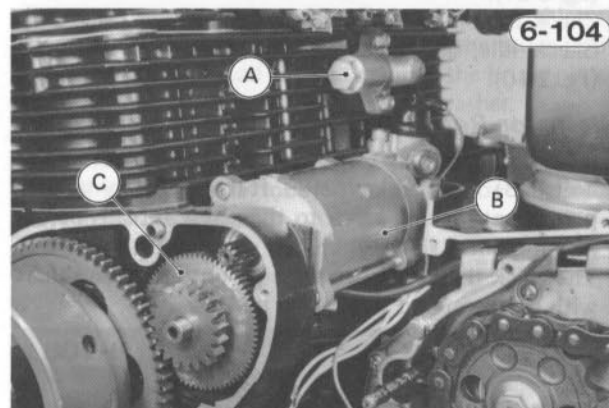

A. Tensioner Cap B. Starter Motor  
C. Redcution Gear

- Remove the starter motor retaining bolts (2).
- Pry the starter motor loose from the crankcase with a screwdriver, slide the starter motor off towards the right side of the engine, and then lift it upwards.

**CAUTION** 1. Do not tap on the starter motor shaft or body. Tapping on the shaft or body may damage the motor.

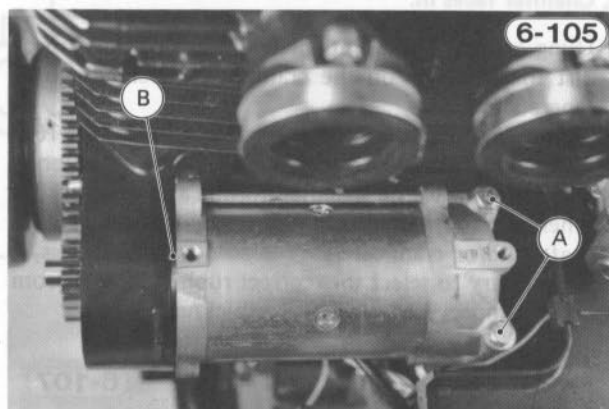

A. Remove retaining bolts. B. Pry motor loose.

- Slide out the rubber cap, remove the starter motor terminal nut and lockwasher, and take the lead off the motor.

### Installation:

#### Starter Motor Installation

- NOTE:**
- Clean the starter motor lugs and crankcase where the starter motor is grounded.
  - Replace the O-ring with a new one, if it is deteriorated or damaged, and apply a littel oil to it.

- Tightening torque for the starter motor terminal nut is 0.50 kg-m (43 in-lbs).
- Apply a non-permanent locking agent to the starter motor retaining bolts.
- Apply a molybdenum disulfide engine assembly grease to the reduction gear shaft.
- Install the tensioner spring and push rod stop as explained in the "Chain Tensioner Installation" (Pg. 6-21).
- Check the oil level, and add oil if necessary (Pg. 2-4).
- Check idle, and adjust the carburetors if necessary (Pg. 2-10).

#### Alternator Rotor and Starter Clutch Installation

- NOTE:** 1. Tightening torque for the starter clutch Allen bolts (3) is 4.0 kg-m (29 ft-lbs). Apply a non-permanent locking agent to the screw threads before installation.
- The thick thrust washer must go onto the crankshaft with its chamfered side facing in.

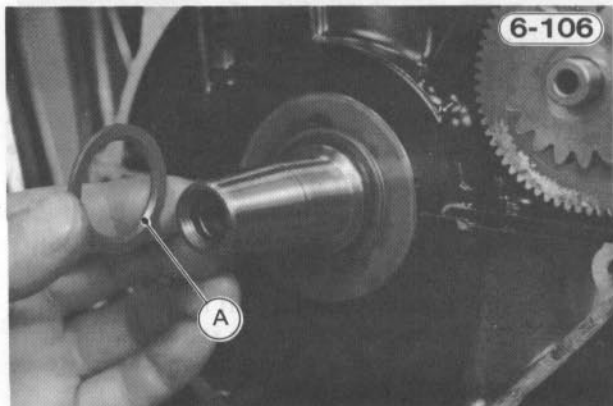

A. Chamfer faces in.

- Using a high flash-point solvent, clean off any oil or dirt that may be on the crankshaft taper and rotor tapered hole.
- Tightening torque for the alternator rotor bolt is 16.0 kg-m (116 ft-lbs). After torquing the bolt, loosen it and tighten it to the specified torque again.
- When the alternator rotor, starter clutch gear, crankshaft, and/or crankcase are replaced with new ones, it is necessary to select the correct rubber damper from three dampers having different thickness.

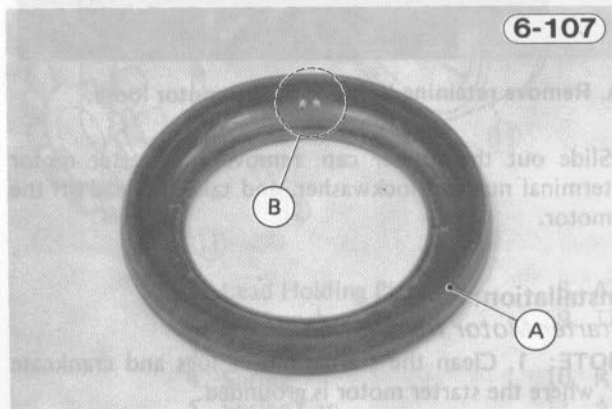

A. Rubber Damper B. Marking

Table 6-2 Rubber Damper

Thickness	Marking	Part No.
6.3 mm	★	97075-1129
7.3 mm	★★	92075-1130
8.3 mm	★★★	92075-1131

The standard rubber damper is 7.3 mm thick, and the starter clutch gear should be rotated by hand with light drag felt. If the starter clutch gear turns freely without drag, replace the rubber damper with the next thicker size; if it cannot be rotated by hand or heavy drag is felt, replace the rubber damper with a next thinner one.

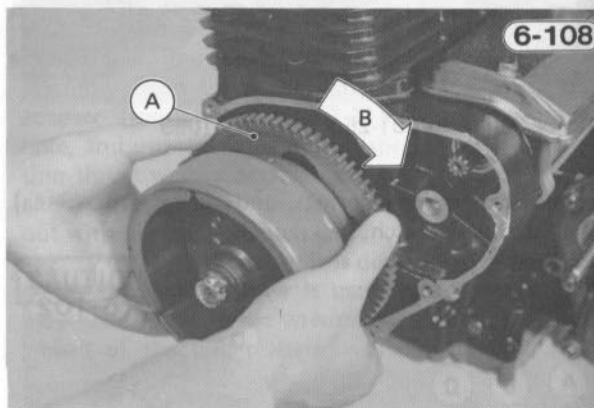

A. Starter Clutch Gear B. Turn

#### Alternator Cover and Alternator Stator Installation

- Apply a liquid gasket around the circumference of the grommet, install the grommet, and set the alternator stator into place.
- Apply a non-permanent locking agent to the stator bolts (3), and tighten the bolts to 1.0 kg-m (87 in-lbs) of torque.
- Fit the leads into the groove and between the two projections, and hold them in place with the lead holding plate. Tighten the screws (2).

**CAUTION**

- Make sure that the lower end of the holding plate is positioned outside the projections. This prevents the plate from interfering with the alternator rotor.

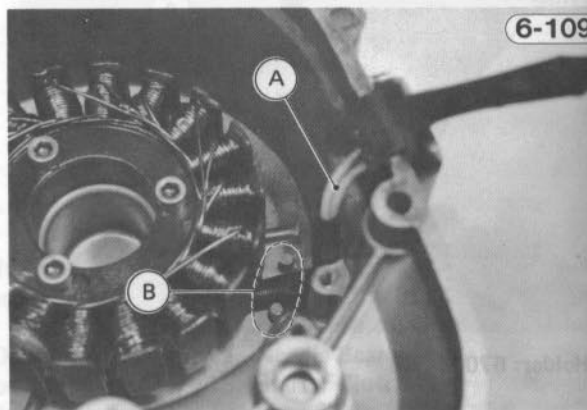

A. Leads B. Projections

- Check that the knock pins (2) are in place, install the alternator cover using a new gasket, and tighten its bolts (8). Apply a non-permanent locking agent to the bolts (2) which go through the knock pins, and apply a liquid gasket to the area of the mating surface indicated in the figure.

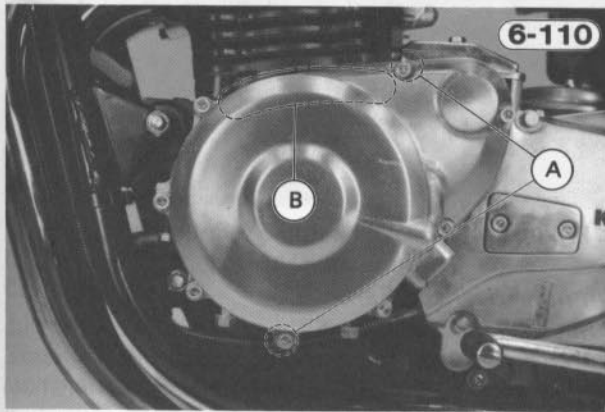

- A. Apply non-permanent locking agent.**  
**B. Apply liquid gasket.**

- Connect the alternator leads (3), and secure them in the clamps.

#### Starter Motor

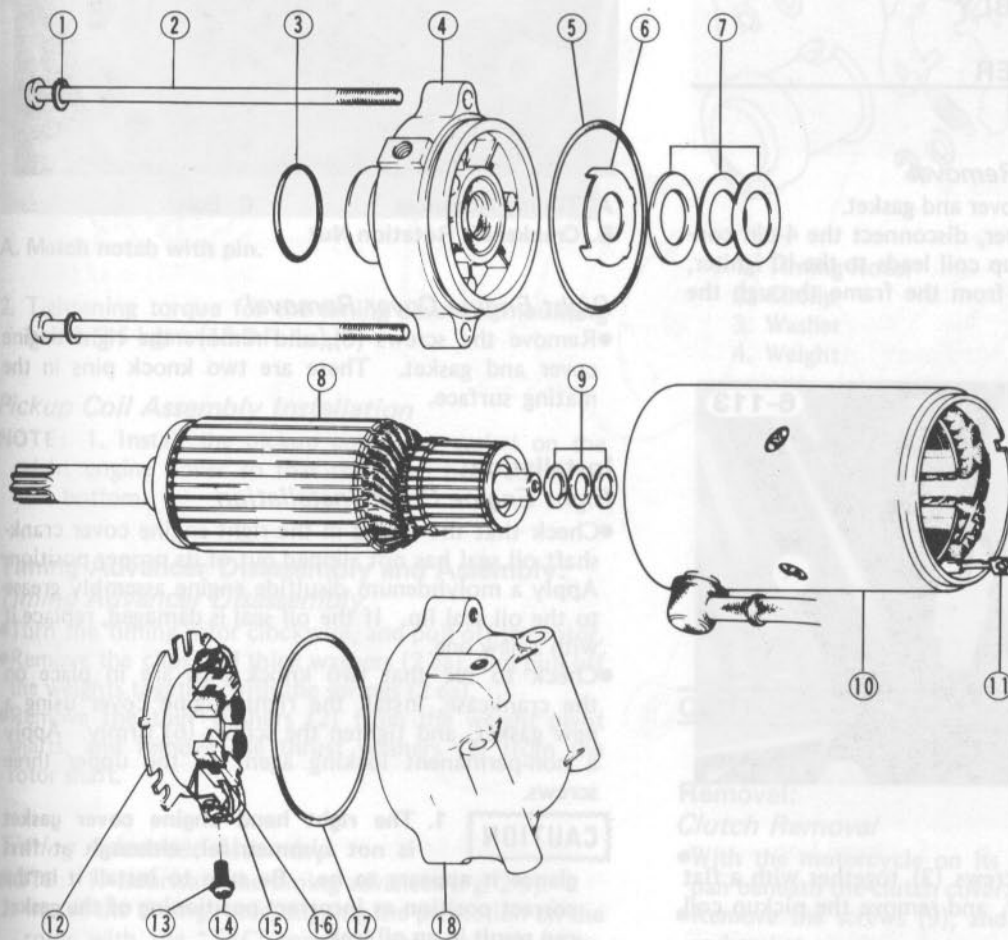

1. Lockwasher
2. Screw
3. O-Ring
4. End Cover
5. O-Ring
6. Toothed Washer
7. Shims
8. Armature
9. Shims
10. Yoke Assembly
11. Field Coil Lead
12. Brush Plate
13. Lockwasher
14. Screw
15. Brush Lead
16. Brush
17. O-Ring
18. End Cover

- Install the engine sprocket cover (Pg. 6-28).
- Check the clutch, and adjust if necessary (Pg. 2-12).
- Check the oil level, and add more if necessary (Pg. 2-4).

#### Starter Motor Disassembly and Assembly:

##### Starter Motor Disassembly

- Remove the screws (2) (2), lockwashers (1) (2), and remove one end cover (18), O-ring (17), and shims (9).
- Remove the screw (14) which connects the brush lead (15) to the field coil lead (11), and remove the brush plate (12) and brushes (16). The screw has a lockwasher.
- Take off the other end cover (4) and O-ring (5), and remove the yoke assembly (10) and armature (8). There are shims (7) and a toothed washer (6) on this side of the armature shaft.

**NOTE:** 1. The yoke assembly (10) is not meant to be disassembled.

##### Starter Motor Assembly

- NOTE:** 1. Replace any O-rings and gaskets that are deteriorated or damaged with new ones.
2. Align the line on the end cover (18) with the line on the housing.

6-111

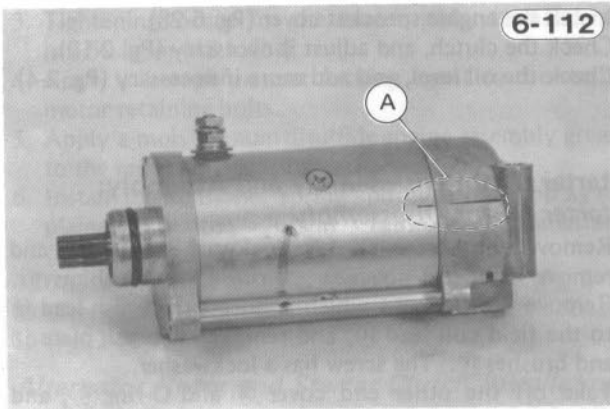

A. Align Lines

permanent locking agent to the upper three screws. The yoke assembly is not to be disassembled. The thick thrust washer must go onto the rotation nut with its chamfered side facing in.



### PICKUP COIL ASSEMBLY TIMING ADVANCER RIGHT ENGINE COVER

#### Removal:

##### Pickup Coil Assembly Removal

- Remove the pickup coil cover and gasket.
- Pull off the right side cover, disconnect the 4-pin connector that join the pickup coil leads to the IC igniter, and slide the leads free from the frame through the clamps.



A. Pickup Coil Connector

- Remove the mounting screws (3) together with a flat washer and a lockwasher, and remove the pickup coil assembly.

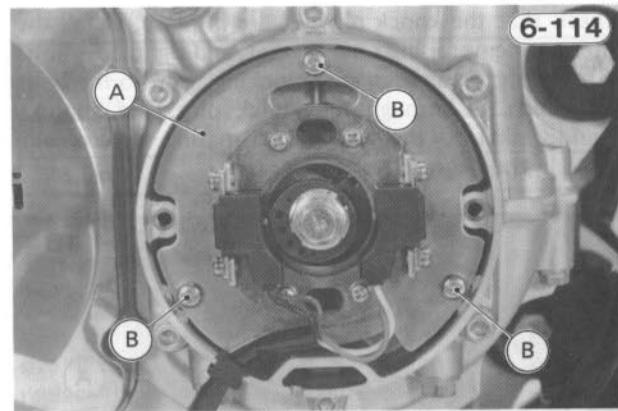

A. Pickup Coil Assembly

B. Screws

##### Timing Advancer Removal

- With a 17 mm wrench on the crankshaft rotation nut to keep the shaft from turning, remove the advancer mounting bolt, and then take off the rotation nut.
- Remove the timing advancer.

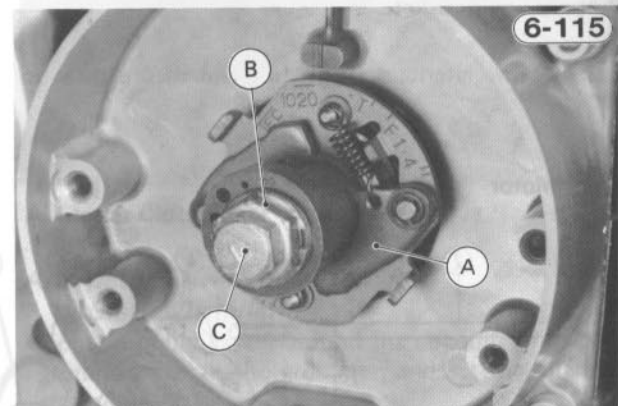

A. Timing Advancer

C. Bolt

B. Crankshaft Rotation Nut

##### Right Engine Cover Removal

- Remove the screws (6), and remove the right engine cover and gasket. There are two knock pins in the mating surface.

#### Installation:

##### Right Engine Cover Installation

- Check that the spring in the right engine cover crankshaft oil seal has not slipped out of its proper position. Apply a molybdenum disulfide engine assembly grease to the oil seal lip. If the oil seal is damaged, replace it with a new one.
- Check to see that two knock pins are in place on the crankcase, install the right engine cover using a new gasket, and tighten the screws (6) firmly. Apply a non-permanent locking agent to the upper three screws.

#### CAUTION

1. The right hand engine cover gasket is not symmetrical, although at first glance it appears to be. Be sure to install it in the correct position as incorrect positioning of the gasket can result in an oil leak.



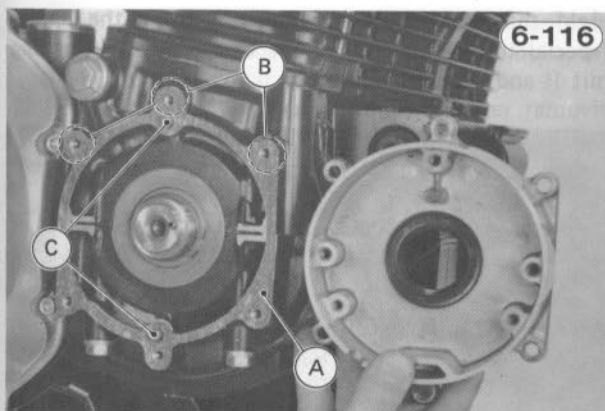

- 6-116**
- A. Fit gasket in correct position.
  - B. Apply non-permanent locking agent.
  - C. Knock Pins

### Timing Advancer Installation

**NOTE:** 1. Fit the timing advancer onto the crankshaft, matching its notch with the pin in the end of the crankshaft.

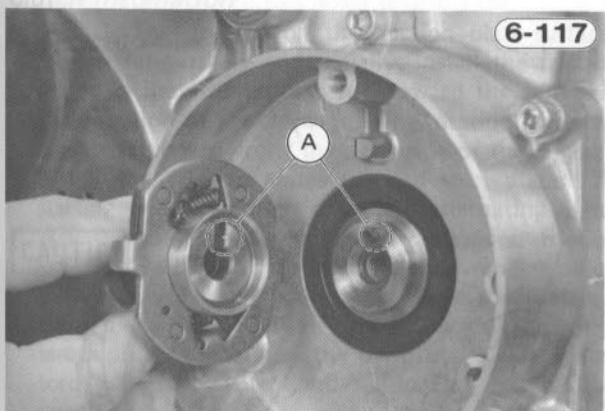

- 6-117**
- A. Match notch with pin.
2. Tightening torque for the timing advancer mounting bolt is 2.5 kg-m (18.0 ft-lbs).

### Pickup Coil Assembly Installation

**NOTE:** 1. Install the pickup coil cover gasket on the right engine cover so that the small hole comes to the bottom.

### Timing Advancer Disassembly and Assembly:

#### Timing Advancer Disassembly

- Turn the timing rotor clockwise, and pull off the rotor.
- Remove the clips and thick washers (2 ea), and pull off the weights together with the springs (2 ea).
- Remove the thin washers (2) from the weight pivot shafts, and remove the thrust washers (2) from the rotor shaft.

#### Removal:

#### Timing Advancer Assembly

- NOTE:** 1. Lubricate the timing advancer (Pg. 2-5).
2. Install the timing rotor, aligning the projection on the rotor with the "TEC" mark on the advancer body.

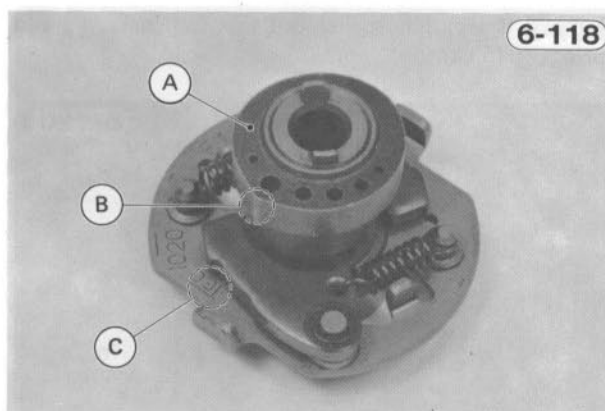

- 6-118**
- A. Timing Rotor
  - B. Projection
  - C. Mark

### Timing Advancer

**6-119**

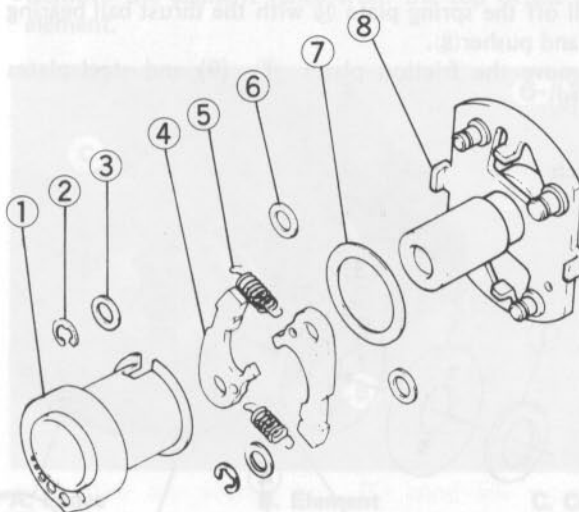

1. Timing Rotor
2. Circlip
3. Washer
4. Weight
5. Spring
6. Washer
7. Washer
8. Advancer Body

---

## CLUTCH

---

### Removal:

#### Clutch Removal

- With the motorcycle on its center stand, place an oil pan beneath the clutch cover:
- Remove the screws (9), and pull off the clutch cover and gasket.

- Remove the clutch spring bolts ⑫, washers ⑬, and springs ⑪ (5 ea).

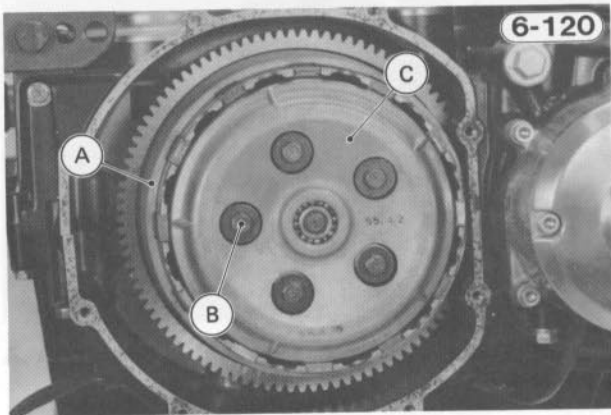

A. Clutch Housing B. Bolt C. Spring Plate

- Pull off the spring plate ⑩ with the thrust ball bearing ⑨ and pusher ⑧.
- Remove the friction plates ⑥ (9) and steel plates ⑦ (8).

Clutch

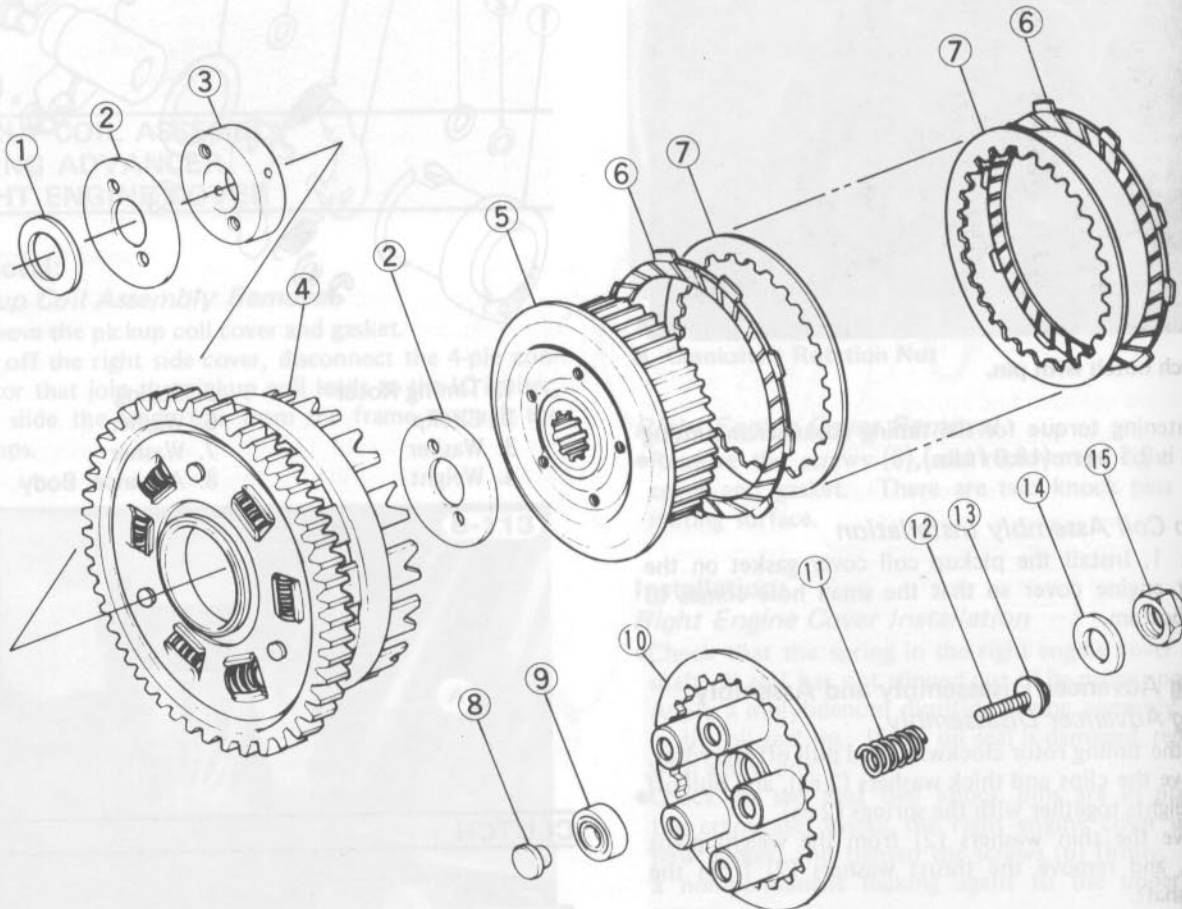

- 1. Washer
- 2. Thrust Washer
- 3. Collar
- 4. Clutch Housing

- 5. Clutch Hub
- 6. Friction Plate
- 7. Steel Plate
- 8. Pusher

- 9. Ball Bearing
- 10. Spring Plate
- 11. Clutch Spring
- 12. Bolt

- 13. Washer
- 14. Washer
- 15. Self-locking Nut

- Hold the clutch hub from turning using the holder (special tool), and remove the clutch hub self-locking nut ⑮ and washer ⑭.

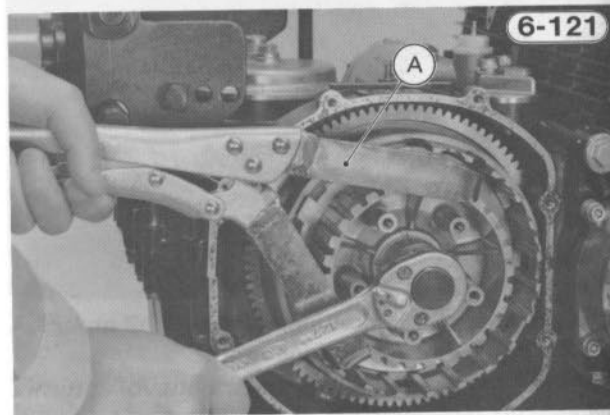

A. Holder: 57001-305

- Pull off the clutch hub ⑤, thrust washer ②, clutch housing bearing collar ③, clutch housing ④, another thrust washer ②, and washer ①.

- NOTE:** 1. The clutch housing bearing collar can easily be pulled off by installing clutch cover bolts into the holes in the collar and pulling them.
2. The clutch housing can be removed after removing the bearing collar.

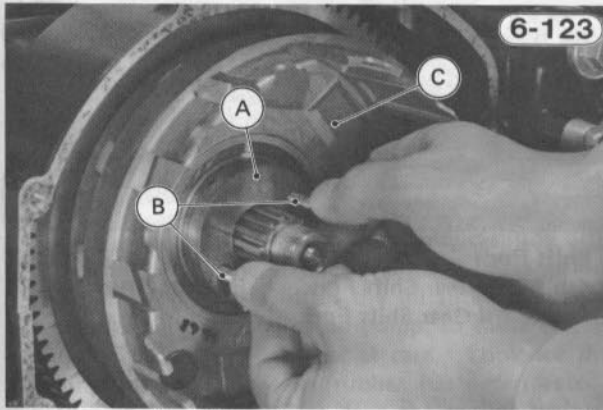

**A. Collar** **C. Clutch Housing**  
**B. Pull off using bolts.**

**Clutch Installation**

- NOTE:** 1. The grooves on the friction plate surfaces are cut tangentially and radially; install the friction plates so that the grooves run toward the center in the direction of the clutch housing rotation (counterclockwise viewed from the right side of the engine).
2. Install the friction plates (8) and steel plates (7), starting with a friction plate and alternating them.

- CAUTION** 1. If new dry steel plates and friction plates are installed, apply engine oil on the surfaces of each plate to avoid clutch plate seizure.
3. Discard the used clutch hub self-locking nut, and screw on a new nut on the drive shaft. Tightening torque for the clutch hub self-locking nut is 13.0 kg-m (94 ft-lbs).
4. Tightening torque for the clutch spring bolts (5) is 0.90 kg-m (78 in-lbs).
5. Check the oil level, and add oil if necessary (Pg. 2-4).
6. Adjust the clutch (Pg. 2-12).

**OIL FILTER ELEMENT**  
**BYPASS VALVE**  
**OIL PAN**  
**ENGINE OIL PUMP**  
**SHIFT MECHANISM**

**Removal:**

**Oil Filter Element and Bypass Valve Removal**

- With the motorcycle up on its center stand, place an oil pan beneath the engine, and remove the engine drain plug to drain out the oil.

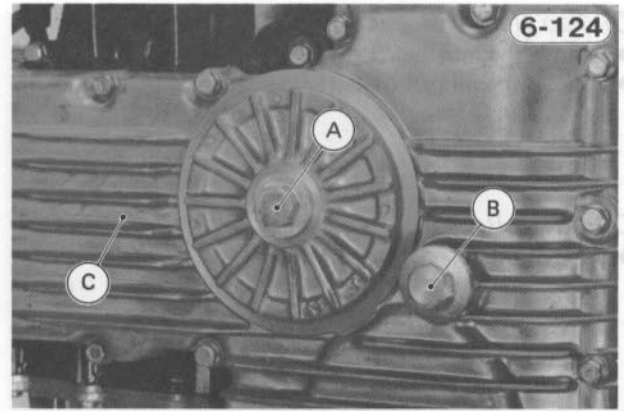

**A. Oil Filter Mounting Bolt** **C. Oil Pan**  
**B. Drain Plug**

- Remove the filter mounting bolt and drop out the filter.
- Remove the element fence from the top of the filter element.

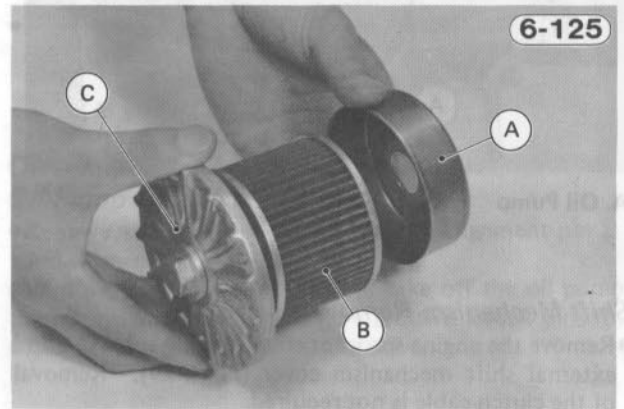

**A. Fence** **B. Element** **C. Cover**

- Holding the element steady, turn the mounting bolt to work the element free.
- Remove the flat washer and spring, and pull the filter cover off the bolt.

**NOTE:** 1. The bypass valve is built in the filter mounting bolt.

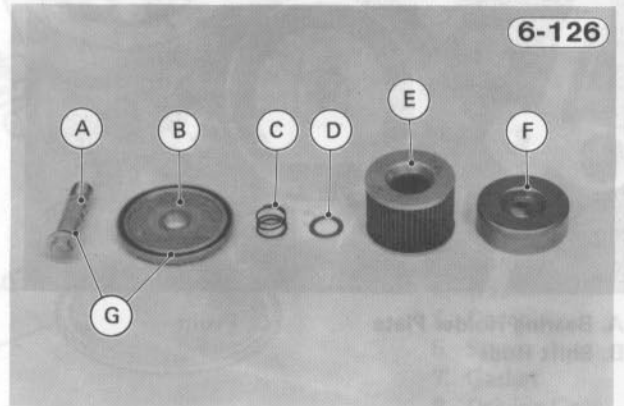

**A. Mounting Bolt** **E. Element**  
**B. Cover** **F. Fence**  
**C. Spring** **G. O-Rings**  
**D. Washer**

**Oil Pan Removal**

- Remove the mufflers (Pg. 6-14).
- Remove the oil pan bolts (17), and take off the oil pan, gasket, and O-ring.

**Oil Pump Removal**

- Remove the engine oil pump bolts (3), and take off the engine oil pump and oil passage O-ring. There are two knock pins.

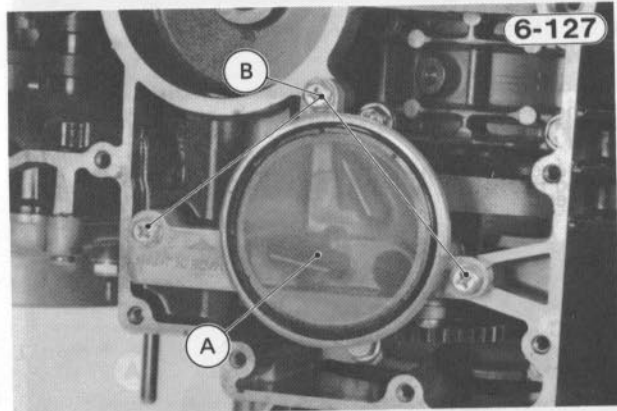

A. Oil Pump      B. Bolts

**Shift Mechanism Removal**

- Remove the engine sprocket cover, engine sprocket, and external shift mechanism cover (Pg. 6-29). Removal of the clutch cable is not required.
- Remove the bolts (2), and remove the shift drum bearing holder plate.

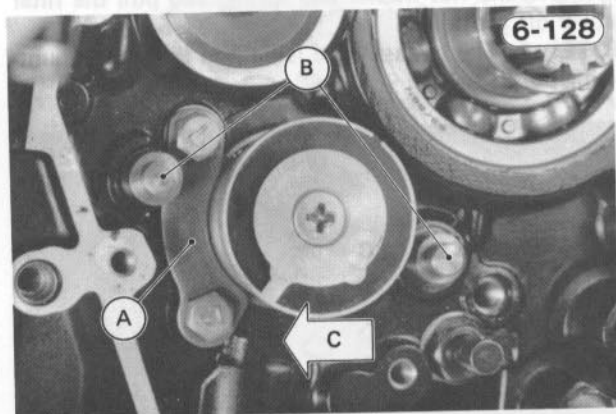

A. Bearing Holder Plate      C. Front  
B. Shift Rods

- Pull out the shift rods (2), and remove the shift forks (3).
- Pull out the shift drum toward the engine left side.

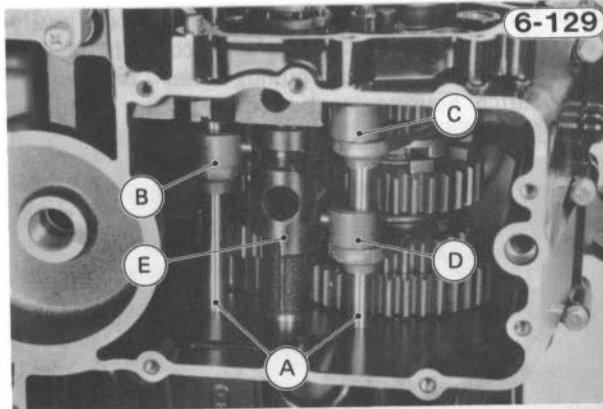

A. Shift Rods      D. 1st Gear Shift Fork  
B. 4th & 5th Gear Shift Fork      E. Shift Drum  
C. 2nd & 3rd Gear Shift Fork

**Installation:**

**Shift Mechanism Installation**

- NOTE:**
1. The rear, two shift forks are identical.
  2. Apply a non-permanent locking agent to the threads of the bolts for the shift drum bearing holder and tighten them to 1.0 kg-m (87 in-lbs) of torque. The bearing holder plate also prevents the front shift rod from coming out. See Fig. 6-128.
  3. Adjust the clutch and drive chain.

**Oil Pump Installation**

- NOTE:**
1. Replace the oil passage O-ring with new one. The flat side of the O-ring must face to the crankcase.

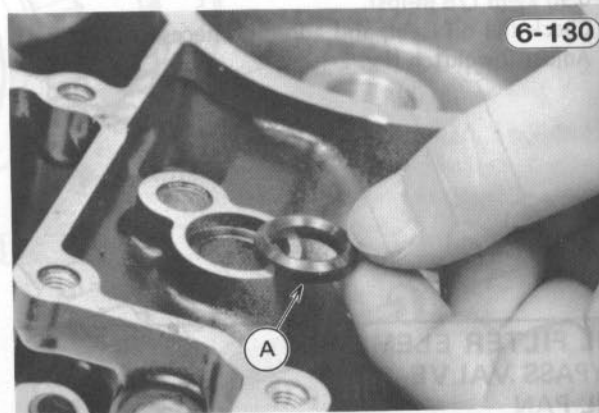

A. O-ring Flat Side.

2. Fill the oil pump with engine oil for initial lubrication.
3. Tightening torque for the oil pump mounting bolts (3) is 0.80 kg-m (69 in-lbs).

### Oil Pan Installation

**NOTE:** 1. Tighten the oil pan bolts (17) to 1.0 kg-m (87 in-lbs) of torque.

### Oil Filter Element and Bypass Valve Installation

● Make sure that the O-rings on the filter mounting bolt, drain plug, and filter cover are all properly in place. Replace the O-ring with a new one if deteriorated or damaged.

#### CAUTION

1. Using damaged or deteriorated O-rings instead of replacing them with new ones will cause oil leaks and eventually result in little or no oil left in the engine. This will cause serious engine damage. The oil in the oil filter housing is pressurized by the engine oil pump, so these O-rings must be inspected with special care. Look for discoloration (indicating the rubber has deteriorated), hardening (the sides which face the mating surfaces are flattened), scoring, or other damage.

● Apply a little engine oil to all the O-rings and the oil filter grommets, and install the following parts on the filter mounting bolt in this order (Fig. 6-126).

- Filter Cover
- Spring
- Washer
- Filter Element
- Element Fence

#### CAUTION

1. When installing the element on the mounting bolt, turn the filter element or the mounting bolt to work the element into place. Be careful that the element grommets do not slip out of place.

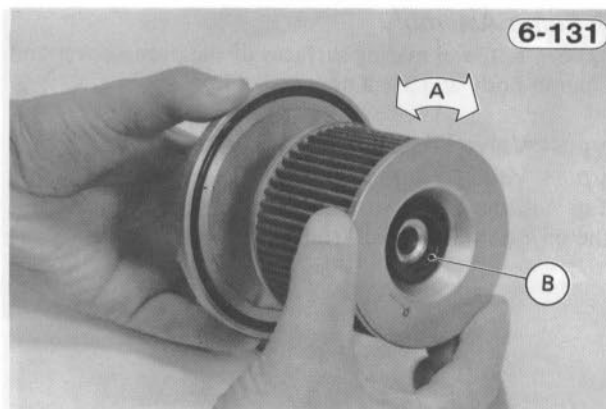

**A.** Work element into place while turning bolt or element.  
**B.** Grommet

- Install the oil filter, and tighten its mounting bolt to 2.0 kg-m (14.5 ft-lbs) of torque.
- Fill the engine with oil, check the oil level, and add more if necessary (Pg. 2-4).

### Oil Pump Disassembly and Assembly:

#### Oil Pump Disassembly

- Remove the circlip ①, main gear ③, alignment pin ② and washer ④.
- Remove the screws ⑥ (5), and take off the oil pump cover ⑤ and gasket ⑦. There are two knock pins ⑫.
- Remove the driving gear ⑧ and driven gear ⑨.

### Oil Pump

A. Pickup Coil 4-pin Connector under Right Side Cover

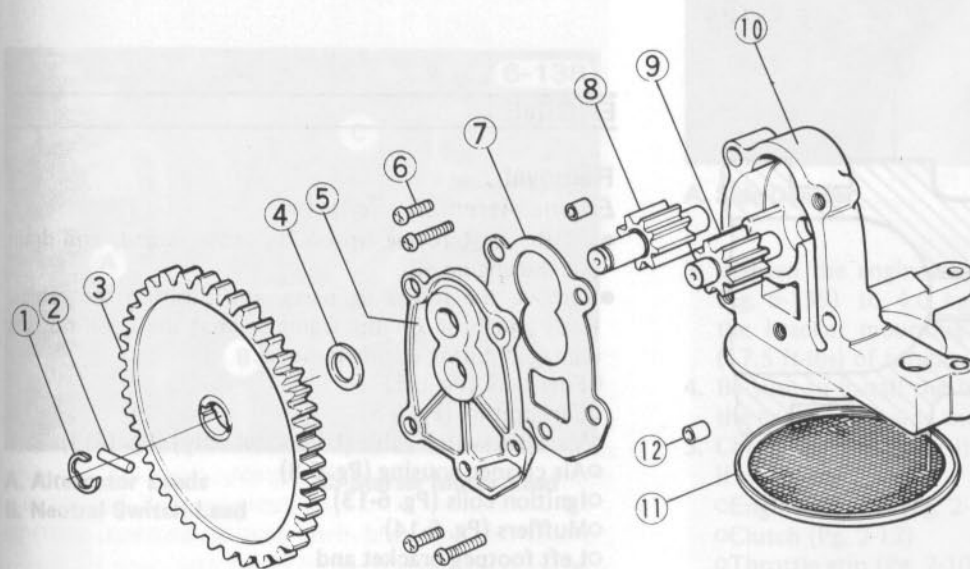

1. Circlip
2. Alignment Pin
3. Main Gear
4. Washer
5. Cover
6. Screw
7. Gasket
8. Driving Gear
9. Driven Gear
10. Pump Body
11. Screen
12. Knock Pin

**6-132**

**Oil Pump Assembly**

**NOTE:** 1. Clean mating surfaces of the pump cover and pump body and use a new gasket in assembly.

**Bypass Valve Disassembly and Assembly:****Bypass Valve Disassembly**

- Tap out the pin with a suitable punch, and drop out the spring and steel ball from the mounting bolt.

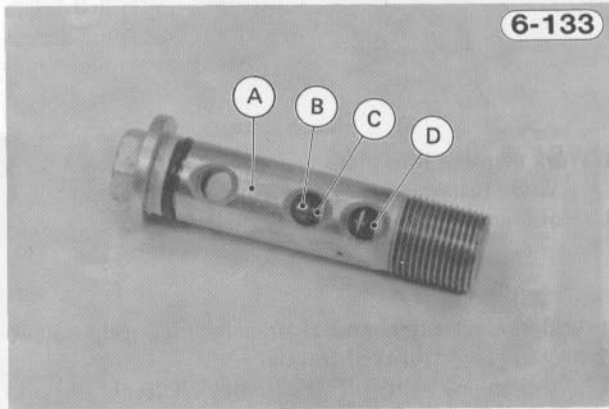

6-133

- A. Mounting Bolt**  
**B. Steel Ball**  
**C. Spring**  
**D. Pin**

**Bypass Valve Assembly**

- Fit the steel ball and spring into the mounting bolt, and drive in the pin while pressing the spring.

**Shift Mechanism Disassembly and Assembly:****Shift Drum Disassembly**

- Remove the pin plate screw ①, and take off the pin plate ②, bearing holder ④ with the shift drum pins ③ (6), and ball bearing ⑥ from the shift drum end. There is a alignment pin ⑤ on the bearing holder to correctly position the bearing holder on the drum.

**Shift Drum Assembly**

6-134

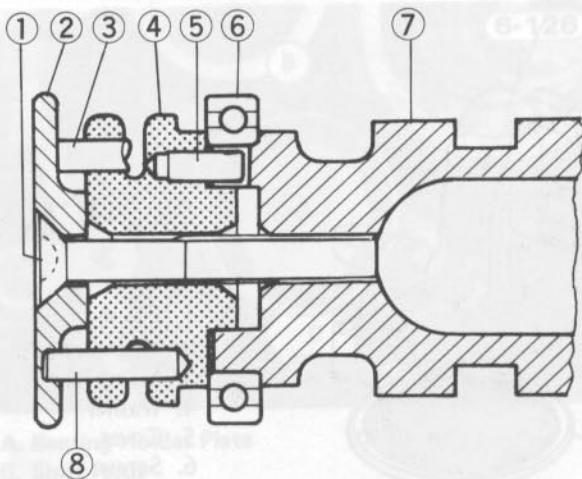

1. Screw  
 2. Pin Plate  
 3. Shift Drum Pin  
 4. Bearing Holder  
 5. Alignment Pin  
 6. Ball Bearing  
 7. Shift Drum  
 8. Long Shift Drum Pin

**Shift Drum Assembly**

**NOTE:** 1. One of the six pins is longer than the others. The long shift drum pin must be installed in the correct position, and must be fitted into the correct hole in the back of the pin plate (Fig. 6-135). If these parts are assembled in the wrong position, the neutral indicator light will not light when the gears are in neutral.

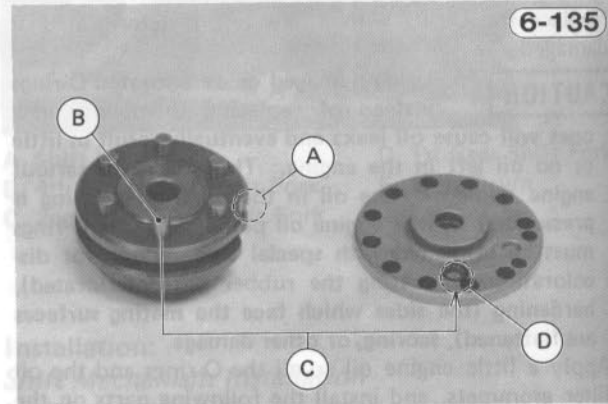

6-135

- A. Neutral Detent**  
**B. Install long pin in this hole.**  
**C. Fit long pin into this hole.**  
**D. Hole with circle marking**

2. Apply a non-permanent locking agent to the pin plate screw.

**ENGINE****Removal:****Engine Assembly Removal**

- Set the motorcycle up on its center stand, and drain out the engine oil.
- Remove the following parts, and position the cables, leads and hose on the frame so that they will not get damaged during engine removal.
  - Fuel tank (Pg. 6-5)
  - Carburetors (Pg. 6-8)
  - Vacuum switch valve (US model only) (Pg. 6-13)
  - Air cleaner housing (Pg. 6-8)
  - Ignition coils (Pg. 6-13)
  - Mufflers (Pg. 6-14)
  - Left footpeg bracket and engine sprocket cover (Pg. 6-28)
  - Engine sprocket (Pg. 6-29)
  - Right footpeg bracket
  - Tachometer cable (KZ1000-M only) (Pg. 7-25)

- Disconnect the following electrical leads and connectors, and position them on the engine and frame so that they will not get damaged during engine removal.

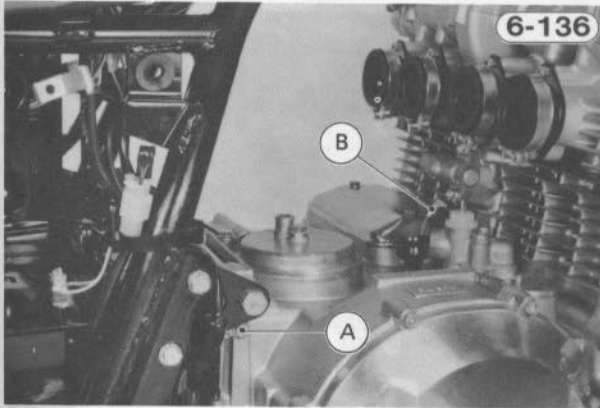

A. Battery Negative Ground Lead  
B. Oil Pressure Switch Lead

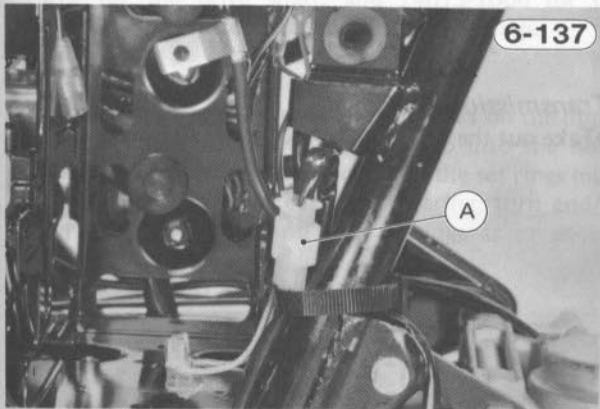

A. Pickup Coil 4-pin Connector under Right Side Cover

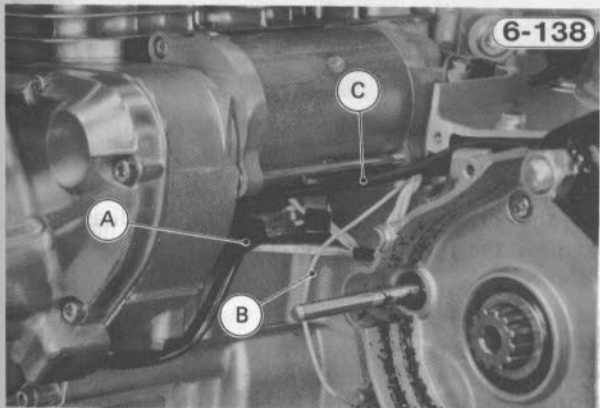

A. Alternator Leads  
B. Neutral Switch Lead  
C. Starter Motor Lead

- Jack or lever the engine up slightly to take the weight off the mounting bolts.
- Remove the following engine mounting bolts (3) and bracket bolts (4), and pull the engine out to the right.

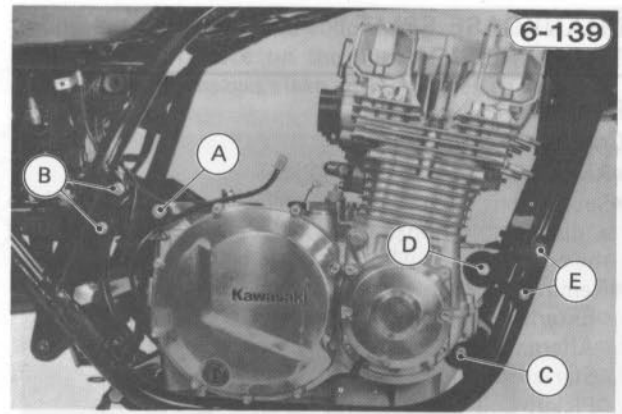

A. Rear Engine Mounting Bolt (283 mm length)  
B. Rear Engine Bracket Bolts  
(regular type head: 45 mm length)  
(flanged type head: 40 mm length)  
C. Front Lower Engine Mounting Bolt (155 mm length)  
D. Front Upper Engine Mounting Bolt (310 mm length)  
E. Front Engine Bracket Bolts (65 mm length)

*Engine Assembly Installation*

- NOTE:** 1. Two spacers go on the rear upper bolt; a long one on the left side of the engine, and a short one on the right side.
2. Check four engine side dampers are installed on the distance collar ends of the upper and lower engine dampers. If they are not, install them in place with a bonding agent.

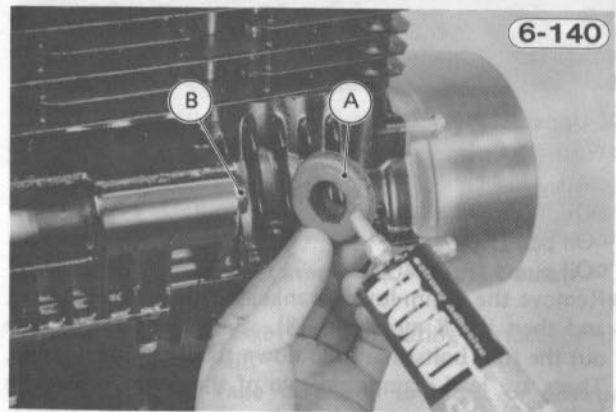

A. Side Damper  
B. Distance Collar

3. Tighten the engine mounting bolts (A, C, and D in Fig. 6-139) to 4.0 kg-m (29 ft-lbs) of torque, and the bracket mounting bolts (B and E) to 2.4 kg-m (17.5 ft-lbs) of torque.
4. Be sure to install the battery negative ground lead on the engine right side and tighten its bolt.
5. Check the following items, and adjust or add them if necessary.
- Engine oil level (Pg. 2-4)
  - Clutch (Pg. 2-12)
  - Throttle grip (Pg. 2-10)
  - Carburetors (Pg. 2-10)
  - Drive chain (Pg. 2-13)
  - Rear brake (Pg. 2-15)
  - Rear brake light switch (Pg. 2-18)

## CRANKCASE SPLIT TRANSMISSION

### Removal:

#### Crankcase Splitting

- Remove the engine (Pg. 6-42).
- Set the engine on a clean surface or, preferably, into a disassembly apparatus with some means of holding the engine steady while parts are being removed.
- Remove the following parts from the engine.
  - External shift mechanism cover
  - Alternator cover and alternator stator (Pg. 6-31)
  - Starter motor (Pg. 6-33)
  - Pickup coil assembly (Pg. 6-36)
  - Timing advancer (Pg. 6-36)
  - Right engine cover (Pg. 6-36)
  - Clutch cover
- Remove the five upper crankcase-half bolts, noting that lead clamps (2) are installed under two of them.

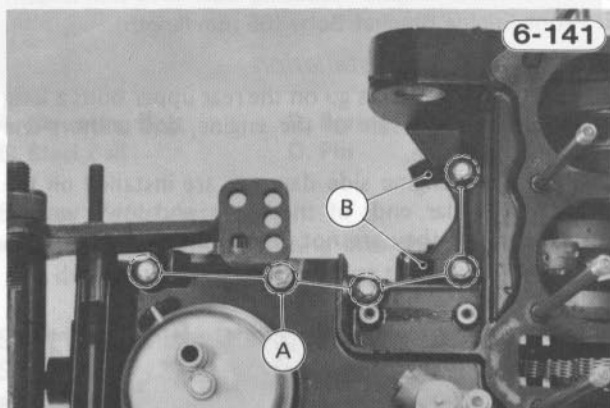

A. Upper Crankcase-Half Bolts      B. Clamps

- Turn the engine upside down and remove the following parts.
  - Oil filter element and bypass valve (Pg. 6-39)
  - Oil pan (Pg. 6-40)
  - Oil pump (Pg. 6-40)
- Remove the 6 mm lower crankcase-half bolts (16) first, and then the 8 mm bolts (8). Be careful not to take out the four bolts that hold down the main bearing cap. There are lead clamps on two of the 6 mm crankcase bolts (16).

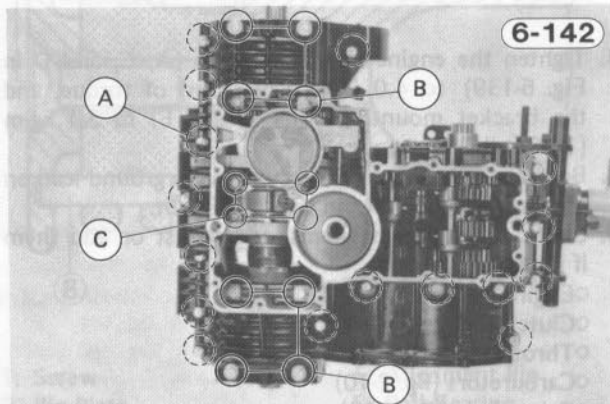

A. 6 mm Bolts      B. 8 mm Bolts  
C. Removal is not necessary for crankcase split.

- Pry the points indicated in the figure to split the crankcase halves apart, and remove the lower crankcase half. There are two knock pins on the front and rear of the mating surface.

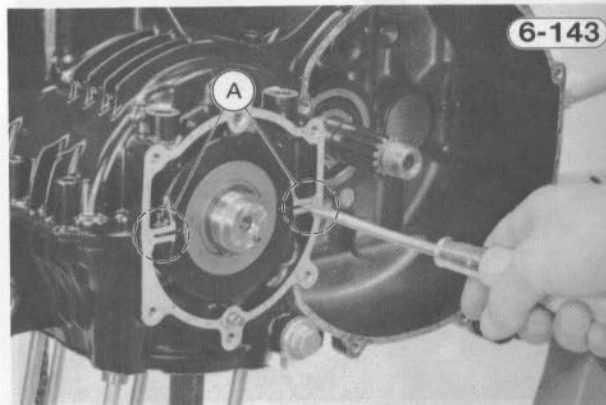

A. Pry Points

### Transmission Removal

- Take out the drive and output shaft assemblies.

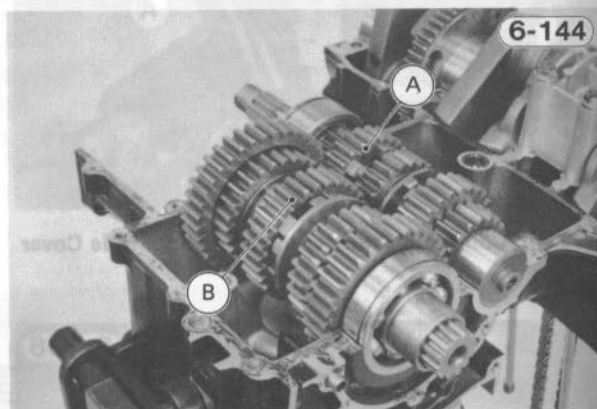

A. Drive Shaft Assembly      B. Output Shaft Assembly

- If the drive shaft assembly is to be disassembled, remove the clutch (Pg. 6-37).

### Installation:

#### Transmission Installation

- Install the clutch (Pg. 6-39) if it has been removed.
- With a high flash-point solvent, clean off the outer circumferences of the transmission ball bearings and needle bearings, and their bearing housings; and wipe dry.
- Check to see that the following parts shown in Fig. 6-145 are in place in the transmission bearing housings, and blow the oil passages in the bearing housings clean with compressed air.



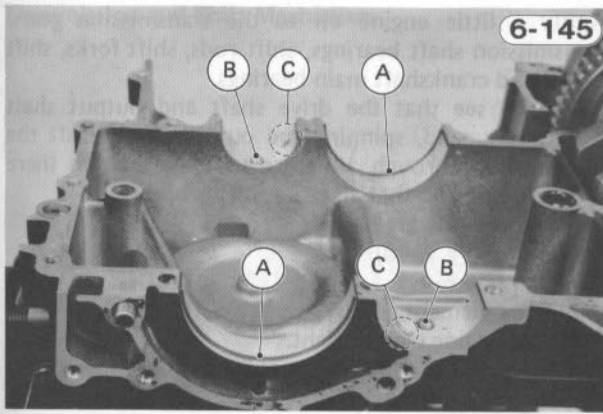

**A. Set Rings**      **C. Oil Passage Holes**  
**B. Set Pins**

**NOTE:** 1. If the standard set rings (P/N: 14013-1004 for the drive shaft, and 14013-1005 for the output shaft) cannot be put into the crankcase and ball bearing grooves, use the thin set rings (P/N: 14013-013 for the drive shaft, and 14013-1006 for the output shaft) instead of the standard set rings.

•Fit the output and drive shaft assemblies on the upper crankcase half. The set pins must go into the holes in the needle bearing outer races, and the set rings must fit into the grooves in each ball bearing; turn and/or slide the outer races and ball bearings as necessary.

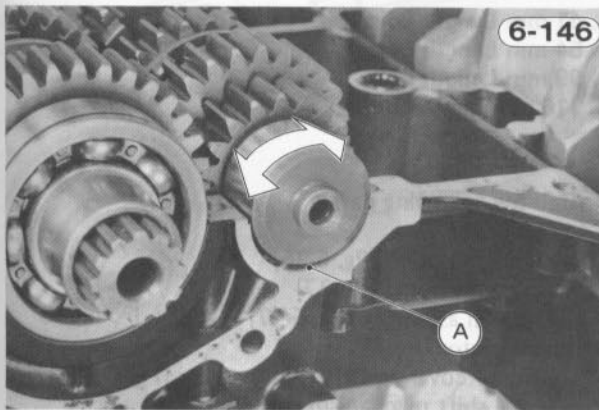

**A. No Gap (for both right and left sides)**

**Crankcase Assembly**

**NOTE:** 1. The upper crankcase half, the lower crankcase half, and the crankshaft main bearing cap are machined at the factory in the assembled state, so the crankcase halves and the main bearing cap must be replaced together as a set.

2. If the crankcase halves are replaced, check that D5 and O1 gears turn freely by hand and replace the steel washer if necessary. See "NOTE 5" on Pgs. 6-48 and 6-49.

•With a high flash-point solvent, clean off the mating surfaces of the crankcases halves and wipe dry.

•Check to see that the following parts shown in Fig. 6-147 are in place on the upper crankcase half, and blow the oil passages clean with compressed air.

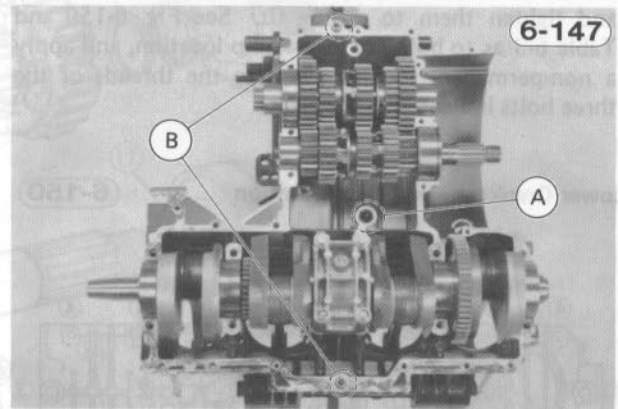

**A. O-ring and Oil Passage**      **B. Knock Pin**

•Check to see that the shift drum is in the neutral position, that is, the neutral positioning lever fits into the detent on the shift drum bearing holder.

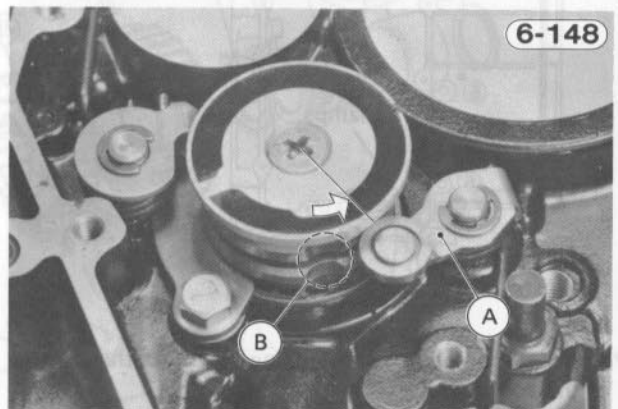

**A. Neutral Positioning Lever**      **B. Neutral Detent**

•Apply a liquid gasket to the mating surface of the lower crankcase half.

**CAUTION** 1. Take care not to block or obstruct the oil plenum chamber return passage with liquid gasket. This could cause air cleaner oiling.

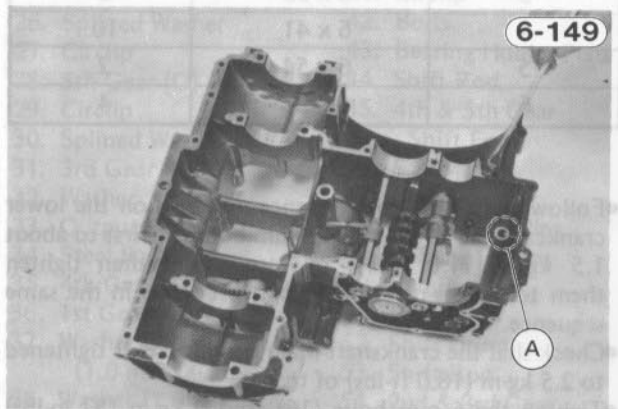

**A. Do not block oil return passage.**

- Fit the lower crankcase half on the upper crankcase half inserting the fingers of each shift fork into the grooves of the gears.
- Put each of the bolts (24) into the lower crankcase half, and tighten them to a snug fit. See Fig. 6-150 and Table 6-3 as to bolt and lead clamp location, and apply a non-permanent locking agent to the threads of the three bolts indicated in the figure.

Lower Crankcase-Half Bolt Location

6-150

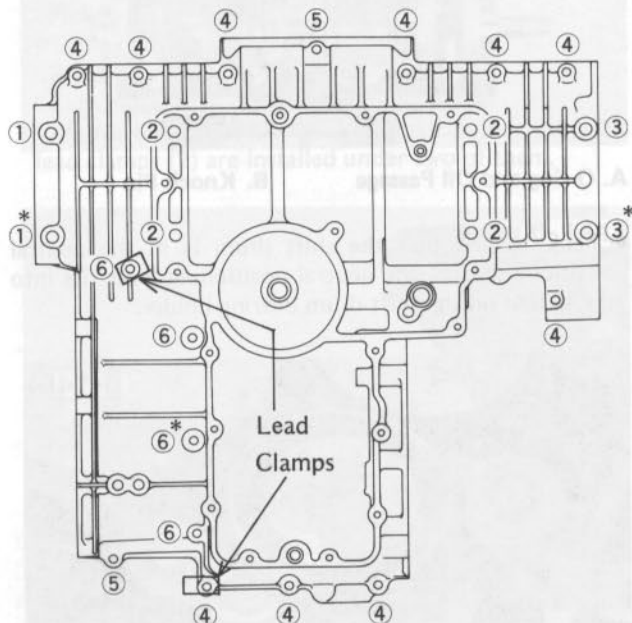

\*Apply a non-permanent locking agent to the threads of these three bolts.

Table 6-3 Lower Crankcase Half Bolts

Reference Number	Dia. x Length mm	Quantity
1	8 x 80	2
2	8 x 72	4
3	8 x 95	2
4	6 x 41	10
5	6 x 54	2
6	6 x 94	4

- Follow the tightening sequence numbers on the lower crankcase half; tighten the 8 mm bolts (8) first to about 1.5 kg-m (11.0 ft-lbs) of torque and then tighten them to 2.5 kg-m (18.0 ft-lbs) of torque in the same sequence.
- Check that the crankshaft main bearing cap is tightened to 2.5 kg-m (18.0 ft-lbs) of torque.
- Tighten the 6 mm bolts (16) to 1.0 kg-m (87 in-lbs) of torque.

- Apply a little engine oil to the transmission gears, transmission shaft bearings, shift rods, shift forks, shift drum, and crankshaft main bearings.
- Check to see that the drive shaft and output shaft turn freely, and, spinning the output shaft, shift the transmission through all gears to make certain there is no binding and that all gears shift properly.
- Install the following parts.
  - Oil pump (Pg. 6-40)
  - Oil pan (Pg. 6-41)
  - Oil filter element and bypass valve (Pg. 6-41)
- Turn the engine over upright.
- Put each of the 6 mm bolts (5) into the upper crankcase half as shown in Fig. 6-151, and tighten them to 1.0 kg-m (87 in-lbs) or torque. Be sure to include the lead clamps (2) with the upper crankcase bolts. The clamps must be bent upwards.

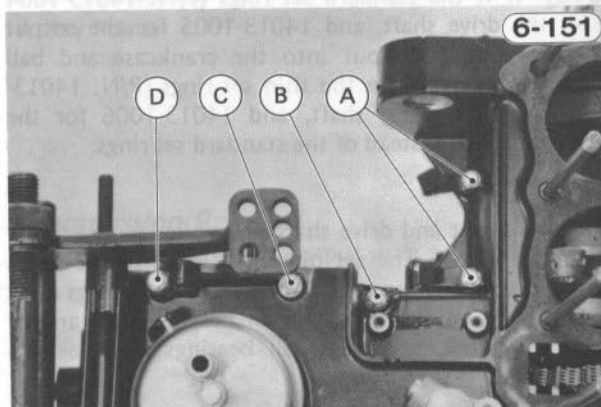

6-151

- A. 41 mm Length Bolts with Lead Clamps
- B. 54 mm Length Bolt
- C. 99 mm Length Bolt
- D. 116 mm Length Bolt

- Install the following parts.
  - Clutch cover
  - Right engine cover (Pg. 6-36)
  - Timing advancer (Pg. 6-37)
  - Pickup coil assembly (Pg. 6-37)
  - Starter motor (Pg. 6-33)
  - Alternator cover and alternator stator (Pg. 6-34)
  - External shift mechanism cover
- Install the engine in the frame (Pg. 6-43).

Drive Shaft Disassembly and Assembly:

Drive Shaft Disassembly

- Remove the needle bearing outer race (2).
- Remove the circlip (3) and pull off the needle bearing (4), steel washers (5) and (6).
- Pull off 2nd gear (7), 5th gear (9), the bushing (8), and splined washer (10).
- Remove the circlip (11), and pull off 3rd gear (12).
- Remove the circlip (13), and pull off the splined washer (14) and 4th gear (15).
- Remove the ball bearing (17). Use the stem bearing puller and adapter (special tools) if it is hard to pull off.

Transmission and Shift Mechanism

6-152

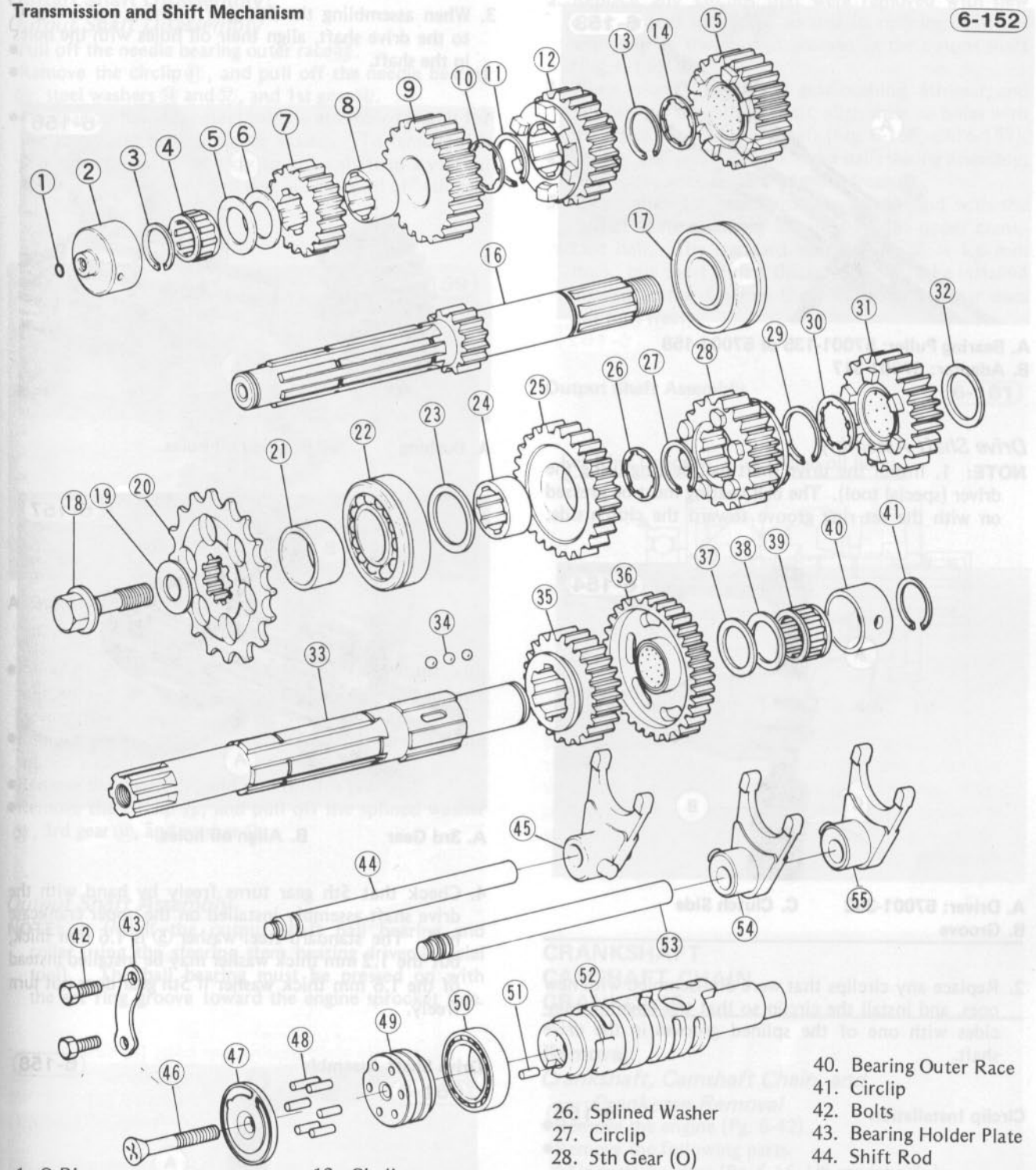

- |                                     |                                      |                               |
|-------------------------------------|--------------------------------------|-------------------------------|
| 1. O-Ring                           | 13. Circlip                          | 40. Bearing Outer Race        |
| 2. Bearing Outer Race               | 14. Splined Washer                   | 41. Circlip                   |
| 3. Circlip                          | 15. 4th Gear (D)                     | 42. Bolts                     |
| 4. Needle Bearing                   | 16. Drive Shaft                      | 43. Bearing Holder Plate      |
| 5. Washer (1.6 or 1.2 mm thickness) | 17. Ball Bearing                     | 44. Shift Rod                 |
| 6. Washer (1.0 mm thickness)        | 18. Bolt                             | 45. 4th & 5th Gear Shift Fork |
| 7. 2nd Gear (D)                     | 19. Bolt Washer                      | 46. Screw                     |
| 8. Bushing                          | 20. Engine Sprocket                  | 47. Pin Plate                 |
| 9. 5th Gear (D)                     | 21. Collar                           | 48. Shift Drum Pins           |
| 10. Splined Washer                  | 22. Ball Bearing                     | 49. Bearing Holder            |
| 11. Circlip                         | 23. Washer                           | 50. Ball Bearing              |
| 12. 3rd Gear (D)                    | 24. Bushing                          | 51. Knock Pin                 |
|                                     | 25. 2nd Gear (O)                     | 52. Shifting Drum             |
|                                     |                                      | 53. Shift Rod                 |
|                                     |                                      | 54. 2nd & 3rd Gear Shift Fork |
|                                     |                                      | 55. 1st Gear Shift Fork       |
|                                     | 26. Splined Washer                   |                               |
|                                     | 27. Circlip                          |                               |
|                                     | 28. 5th Gear (O)                     |                               |
|                                     | 29. Circlip                          |                               |
|                                     | 30. Splined Washer                   |                               |
|                                     | 31. 3rd Gear (O)                     |                               |
|                                     | 32. Washer                           |                               |
|                                     | 33. Output Shaft                     |                               |
|                                     | 34. Steel Balls                      |                               |
|                                     | 35. 4th Gear (O)                     |                               |
|                                     | 36. 1st Gear (O)                     |                               |
|                                     | 37. Washer (1.0 mm thickness)        |                               |
|                                     | 38. Washer (1.6 or 1.2 mm thickness) |                               |
|                                     | 39. Needle Bearing                   |                               |

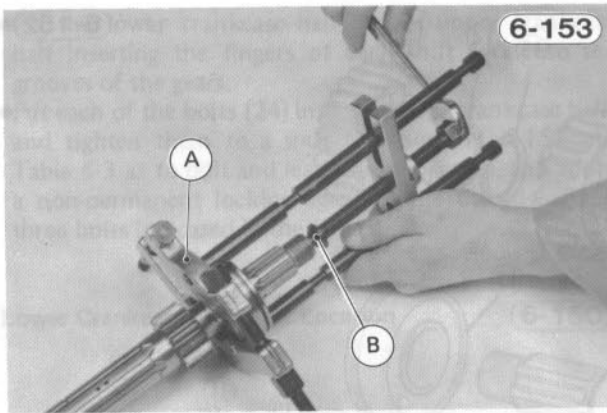

A. Bearing Puller: 57001-135 or 57001-158  
 B. Adapter: 57001-317

**Drive Shaft Assembly**

**NOTE:** 1. Install the drive shaft ball bearing using the driver (special tool). The ball bearing must be pressed on with the set ring groove toward the clutch side.

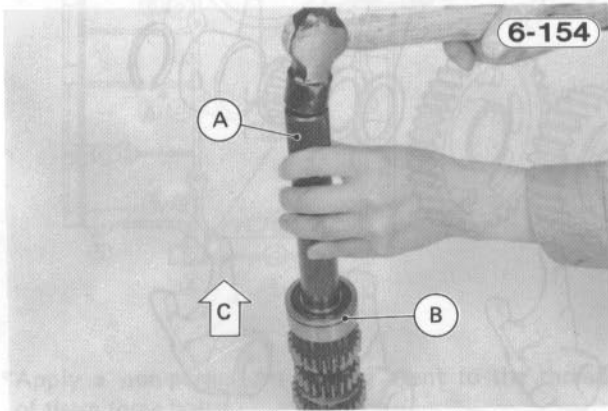

A. Driver: 57001-382 C. Clutch Side  
 B. Groove

2. Replace any circlips that were disassembled with new ones, and install the circlip so that the opening coincides with one of the splined grooves in the drive shaft.

**Circlip Installation**

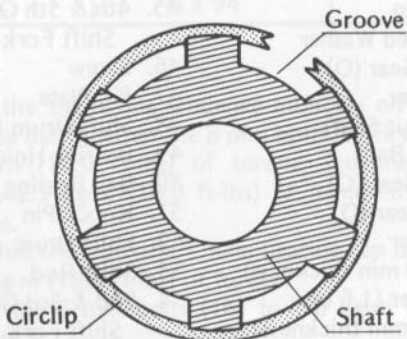

3. When assembling the 5th gear bushing and 3rd gear to the drive shaft, align their oil holes with the holes in the shaft.

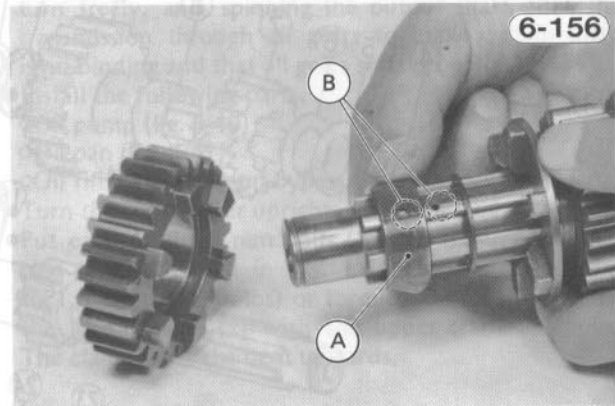

A. Bushing B. Align oil holes.

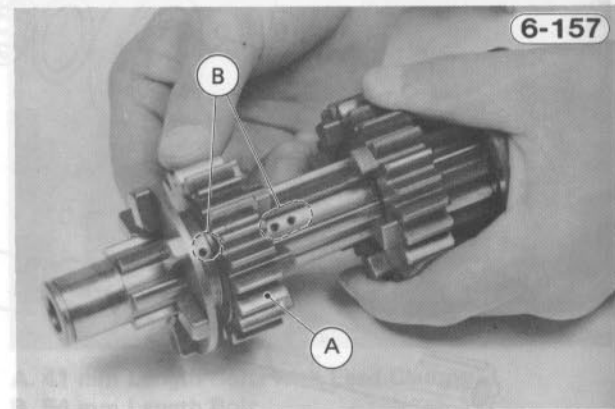

A. 3rd Gear B. Align oil holes.

4. Check that 5th gear turns freely by hand with the drive shaft assembly installed on the upper crankcase half. The standard steel washer (5) is 1.6 mm thick, but the 1.2 mm thick washer may be installed instead of the 1.6 mm thick washer if 5th gear does not turn freely.

**Drive Shaft Assembly**

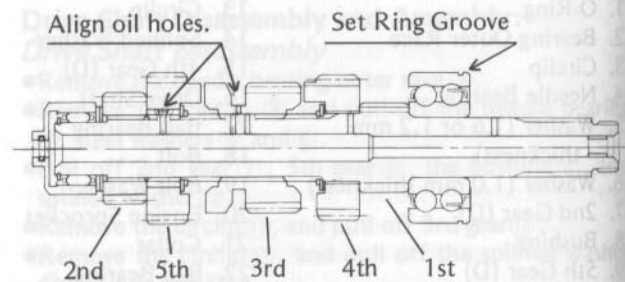

**Output Shaft Disassembly:****Output Shaft Disassembly**

- Pull off the needle bearing outer race (40).
- Remove the circlip (41), and pull off the needle bearing (39), steel washers (38) and (37), and 1st gear (36).
- 4th gear (35) has three steel balls (34) assembled into it for the automatic neutral finder system. To remove this gear with the balls, quickly spin the shaft in a vertical position while holding 3rd gear (31), and pull off 4th gear upwards.

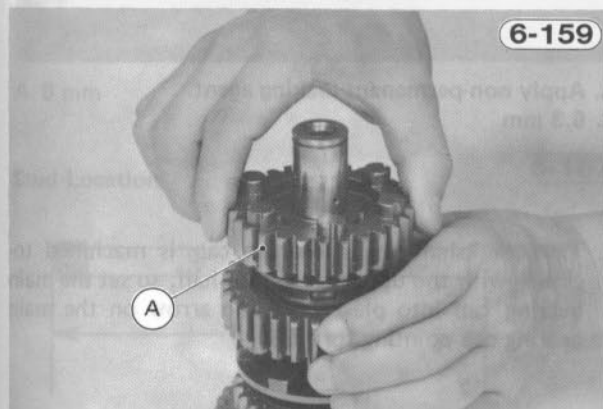

6-159

**A. Quickly spin 4th gear.**

- Remove the output shaft ball bearing (22) together with the collar (21) using the stem bearing puller and adapter (special tools).
- Remove the washer (23), 2nd gear (25), bushing (24), and splined washer (26).
- Remove the circlip (27), and pull off 5th gear (28).
- Remove the circlip (29), and pull off the splined washer (30), 3rd gear (31), and washer (32).

**Output Shaft Assembly**

**NOTE:** 1. Install the output shaft ball bearing and collar using the steering stem bearing driver (special tool). The ball bearing must be pressed on with the set ring groove toward the engine sprocket side.

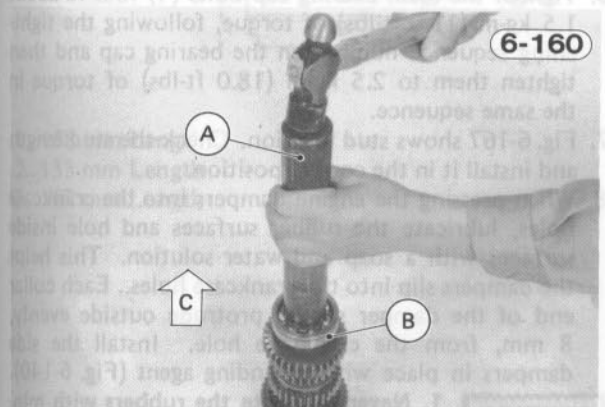

6-160

A. Driver: 57001-137  
B. Groove

C. Engine Sprocket Side

2. Replace any circlips that were removed with new ones. Install the circlip so that its opening coincides with one of the splined grooves in the output shaft (Fig. 6-155).
3. When assembling the 2nd gear bushing, 4th gear, and 5th gear to the output shaft, align their oil holes with the holes in the output shaft (Fig. 6-156, and 6-157).
4. Do not use grease on the three balls during assembly; these balls must be able to move freely.
5. Check that 1st gear turns freely by hand with the output shaft assembly installed on the upper crankcase half. The standard steel washer (38) is 1.6 mm thick, but the 1.2 mm thick washer may be installed instead of the 1.6 mm thick washer if 1st gear does not turn freely.

**Output Shaft Assembly**

6-161

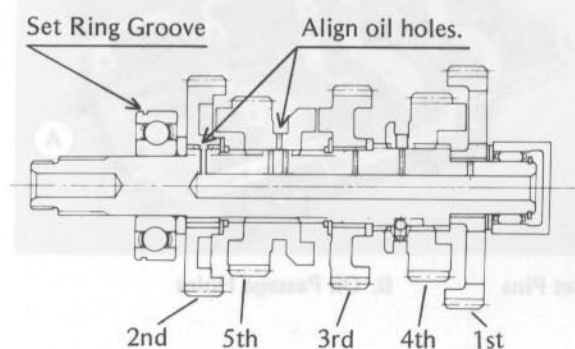

3. Fit the camshaft chain back onto the sprocket and set the crankshaft back in its place on the upper crankcase half while aligning each set pin in the crankcase half with the hole in the crankshaft bearing outer race. Turn and/or slide the outer race as necessary.

## CRANKSHAFT CAMSHAFT CHAIN CRANKCASE

**Removal:****Crankshaft, Camshaft Chain, and Crankcase Removal**

- Remove the engine (Pg. 6-42).
- Remove the following parts.
  - Air suction valves (Pg. 6-15, US model only)
  - Cylinder head cover (Pg. 6-15)
  - Camshaft chain tensioner (Pg. 6-17)
  - Camshafts and sprockets (Pg. 6-18)
  - Cylinder head (Pg. 6-18)
  - Cylinder block (Pg. 6-24)
  - Pistons (Pg. 6-25)
  - Breather cover (Pg. 6-27)
  - Oil pressure switch and oil passage pipe (Pg. 6-27)
  - Alternator rotor and starter clutch (Pg. 6-32)
- Split the crankcase (Pg. 6-44).
- Remove the transmission (Pg. 6-44).

- Remove the bolts (4) and remove the crankshaft main bearing cap.
- Lift off the crankshaft with the camshaft chain.
- Slip the camshaft chain off the crankshaft.

### Crankshaft, Camshaft Chain, and Crankcase Installation

- NOTE:** 1. Blow the oil passages clean with compressed air.  
2. Check that six crankshaft bearing set pins are in place.

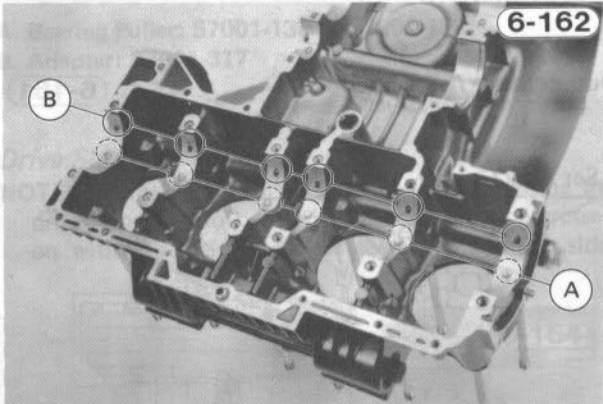

A. Set Pins      B. Oil Passage Holes

3. Fit the camshaft chain back onto the sprocket, and set the crankshaft back in its place on the upper crankcase half while aligning each set pin in the upper crankcase half with the hole in the crankshaft bearing outer race. Turn and/or slide the outer races as necessary.

A. Driver: 57901-002      C. Clutch Side

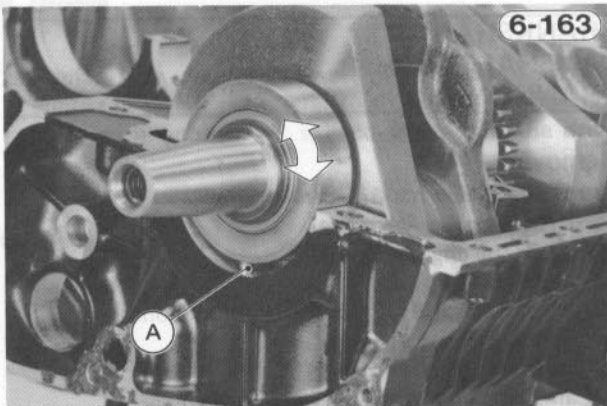

A. No Gap

4. If the camshaft chain anti-rattle bolt was removed, apply a non-permanent locking agent to the bolt threads and tighten it securely from inside the main bearing cap. The bolt head height should be 6.3 mm.

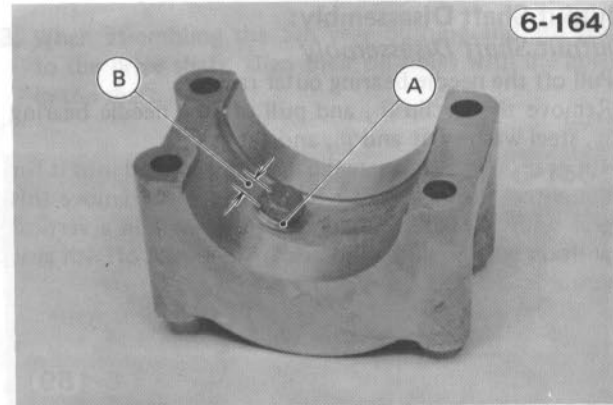

A. Apply non-permanent locking agent.  
B. 6.3 mm

5. The crankshaft main bearing cap is machined together with the upper crankcase half, so set the main bearing cap into place with the arrow on the main bearing cap pointing forward.

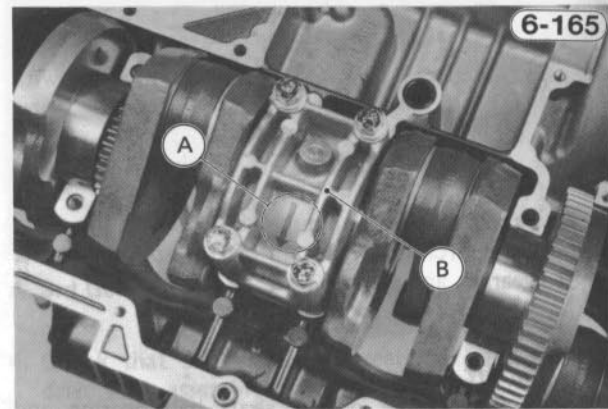

A. Front      B. Main Bearing Cap

6. Tighten the main bearing cap bolts (4) first to about 1.5 kg-m (11.0 ft-lbs) of torque, following the tightening sequence number on the bearing cap and then tighten them to 2.5 kg-m (18.0 ft-lbs) of torque in the same sequence.
7. Fig. 6-167 shows stud location. Check the stud length and install it in the correct position.
8. When pressing the engine dampers into the crankcase holes, lubricate the rubber surfaces and hole inside surfaces with a soap and water solution. This helps the dampers slip into the crankcase holes. Each collar end of the damper should protrude outside evenly, 8 mm, from the crankcase hole. Install the side dampers in place with a bonding agent (Fig. 6-140).

#### CAUTION

1. Never lubricate the rubbers with mineral oil because this will cause deterioration of the dampers.

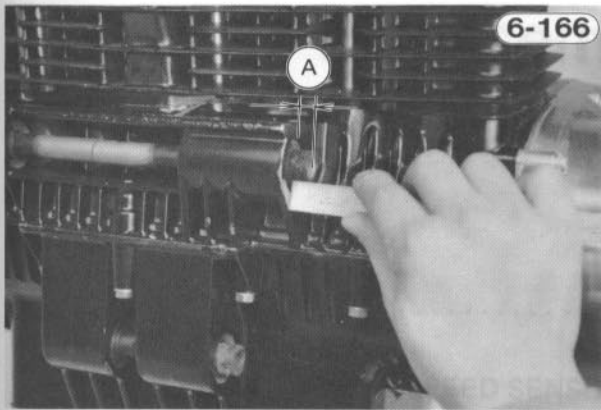

A. 8 mm

Stud Location

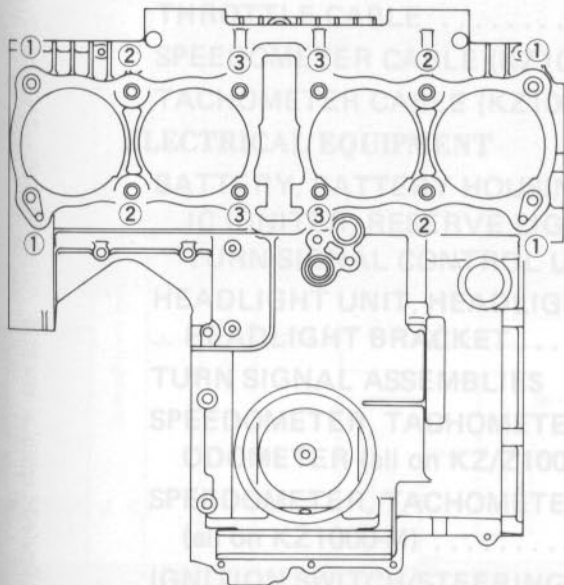
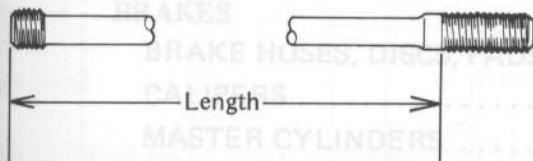

- 1. 158 mm Length
- 2. 133 mm Length
- 3. 167 mm Length

6-166

6-167

# Assembly - Chassis

## Table of Contents

.....	7-2
.....	7-3
.....	7-7
.....	7-11
.....	7-14
.....	7-16
.....	7-18
.....	7-22
.....	7-24
.....	7-25
.....	7-25
.....	7-27
.....	7-30
.....	7-31
.....	7-35
.....	7-37
.....	7-37
.....	7-38
.....	7-39
.....	7-40
.....	7-42
.....	7-46
.....	7-46

# Disassembly – Chassis

## Table of Contents

Removal:		
Front Wheel and Speed Sensor, Speedometer Gear Housing (for KZ1000-M) Removal		
*See the motorcycle up on its CENTER STAND.		
*Disconnect the front fork spring from the front fork.		
FLOW CHART	.....	7-2
<b>WHEELS</b>		
FRONT WHEEL, SPEED SENSOR OR SPEEDOMETER GEAR HOUSING	.....	7-3
REAR WHEEL, WHEEL COUPLING	.....	7-7
TIRES, TUBES (KZ1000-M), SPOKES (KZ1000-M)		
RIMS (KZ1000-M)	.....	7-11
<b>BRAKES</b>		
BRAKE HOSES, DISCS, PADS	.....	7-14
CALIPERS	.....	7-16
MASTER CYLINDERS	.....	7-18
<b>CABLES</b>		
CLUTCH CABLE	.....	7-22
THROTTLE CABLE	.....	7-24
SPEEDOMETER CABLE (KZ1000-M)	.....	7-24
TACHOMETER CABLE (KZ1000-M)	.....	7-25
<b>ELECTRICAL EQUIPMENT</b>		
BATTERY, BATTERY HOUSING, REGULATOR/RECTIFIER, IC IGNITER, RESERVE LIGHTING DEVICE (KZ1000-J, K), TURN SIGNAL CONTROL UNIT (KZ/Z1000-K)	.....	7-25
HEADLIGHT UNIT, HEADLIGHT HOUSING, HEADLIGHT BRACKET	.....	7-27
TURN SIGNAL ASSEMBLIES	.....	7-30
SPEEDOMETER, TACHOMETER, FUEL GAUGE, ODOMETER (all on KZ/Z1000-J, K)	.....	7-31
SPEEDOMETER, TACHOMETER (all on KZ1000-M)	.....	7-35
IGNITION SWITCH/STEERING LOCK ASSEMBLY	.....	7-37
BRAKE LIGHT SWITCHES	.....	7-37
HANDLEBAR SWITCH HOUSING, STARTER LOCKOUT SWITCH	.....	7-38
<b>STEERING</b>		
HANDLEBAR	.....	7-39
STEERING STEM, STEM BEARINGS	.....	7-40
<b>SUSPENSIONS, DRIVE CHAIN</b>		
FRONT FORK	.....	7-42
REAR SHOCK ABSORBERS	.....	7-46
SWING ARM, DRIVE CHAIN	.....	7-46





## FRONT WHEEL SPEED SENSOR (KZ/Z1000-J, K) SPEEDOMETER GEAR HOUSING (KZ1000-M)

### Removal:

#### Front Wheel and Speed Sensor (Speedometer Gear Housing for KZ1000-M) Removal

- Set the motorcycle up on its center stand.
- Disconnect following parts and keep it away from the front fork and frame so that they will not get damaged during wheel removal.
  - One of the front brake calipers (Pg. 7-16)
  - KZ/Z1000-J, K: Speed sensor wiring harness — Disconnect the 3-pin connector in the headlight housing.
  - KZ1000-M: Lower end of the speedometer cable

### All Models:

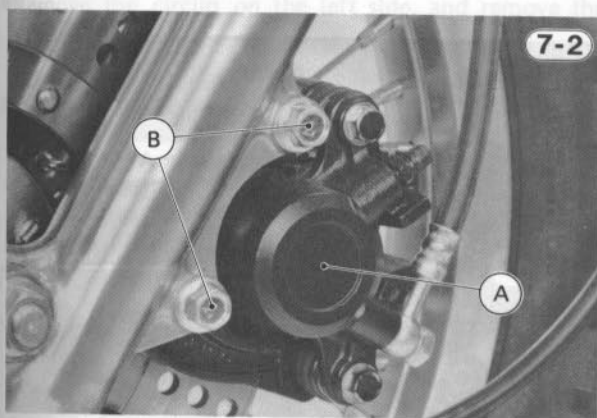

A. Caliper

B. Caliper Mounting Bolts

### KZ/Z1000-J, K:

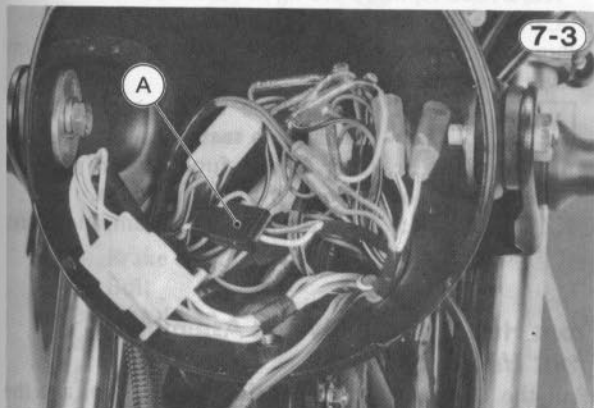

A. Speed Sensor Connector (3-pin, Black)

### KZ1000-M:

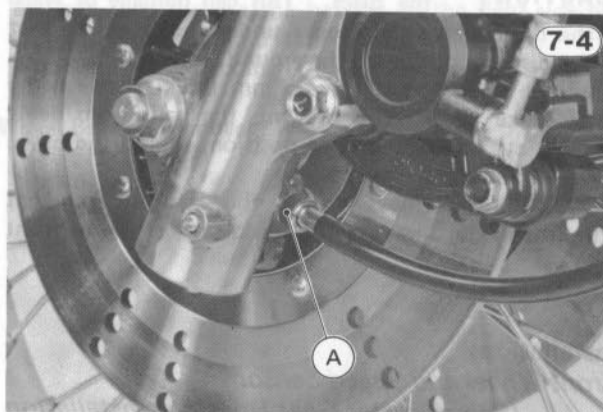

A. Unscrew cable nut, and free meter cable.

- Loosen or remove the fasteners shown in the figures.

### KZ/Z1000-J:

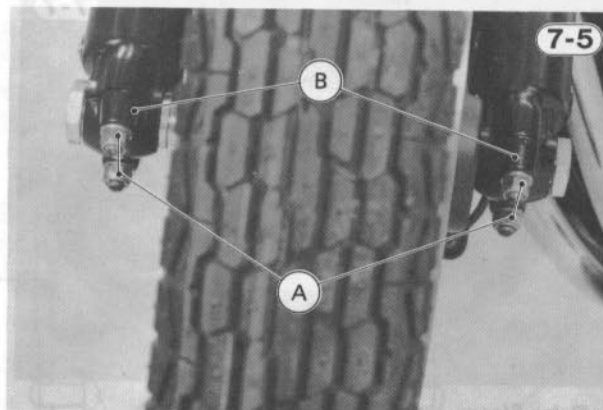

A. Remove four nuts.

B. Remove two clamps.

### KZ/Z1000-K, M:

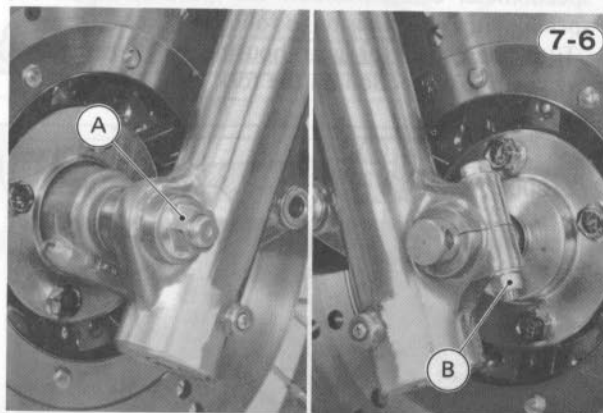

A. Remove axle nut.

B. Loosen clamp bolt.

- Use a jack under the engine or other suitable means to lift the front wheel off the ground, and remove the front wheel with the speed sensor (KZ/Z1000-J, K) or speedometer gear housing (KZ1000-M).

**CAUTION**

1. Do not lay the wheel down on one of the discs. This can damage or warp the disc. Place the blocks under the wheel so that the discs do not touch the ground.

- Insert a wood wedge (4 – 5 mm thick) between the disc brake pads. This prevents the pads from being moved out of their proper position, should the brake lever be squeezed accidentally.
- KZ/Z1000-J: Remove one of the axle nut, pull out the front axle, and take the speed sensor off the front hub.

**Installation:****Front Wheel and Speed Sensor****(Speedometer Gear Housing) Installation**

**NOTE:** 1. Properly engage the drive sleeve with the speed sensor (KZ/Z1000-J, K) or speedometer gear housing (KZ1000-M).

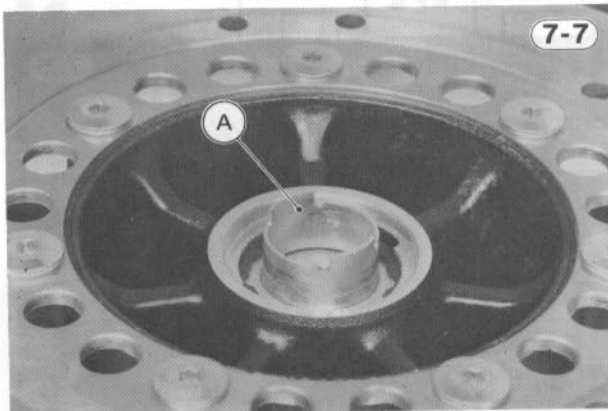

A. Drive Sleeve

2. To properly route the speed sensor wiring harness or speedometer cable, position the speed sensor or the speedometer gear housing as follows:
- Turn the sensor or gear housing so that it stops against the projection on the fork leg.

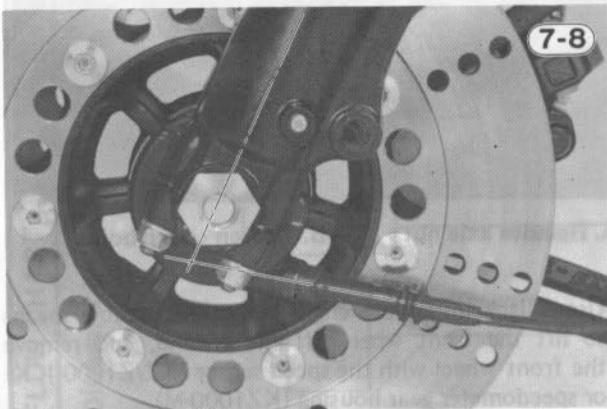
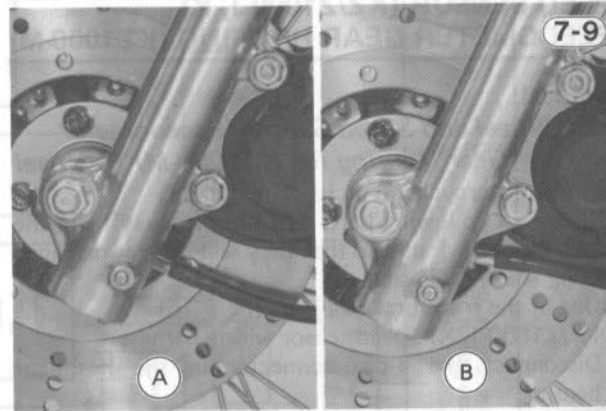
**KZ/Z1000-J, K:****KZ1000-M:**

A. Good

B. Bad

3. KZ/Z1000-J: Install the front axle clamps so that the arrow mark on the clamp point to the front, tighten first the front axle clamp nut and then the rear nut to the specified torque. There will be a gap at the rear of the clamp after tightening.

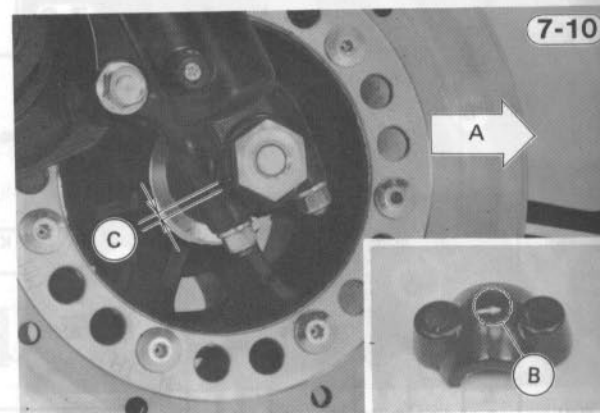

A. Front

B. Arrow Mark

C. Gap

4. Tightening torques for the fasteners are as follows:
- Front axle nut (two for KZ/Z1000-J, one for KZ/Z1000-K, M) – 7.0 kg-m (51 ft-lbs)
  - Front axle clamp nut (four for KZ/Z1000-J, one for KZ/Z1000-K, M) – 1.8 kg-m (13.0 ft-lbs).
  - Caliper mounting bolts (2) – 3.3 kg-m (24 ft-lbs).
5. Pump the brake lever several times until a full, firm lever “feel” is obtained.

**WARNING**

1. Do not ride the motorcycle until the pads are seated against the discs.

The front brakes will not function on the first application of the lever if this is not done.

6. KZ/Z1000-J, K: Check the headlight beam, and adjust it if necessary.

**Front Hub Disassembly and Assembly:****Front Hub Disassembly**

- Pull the collar off the right side of the hub, and the speed sensor or speedometer gear housing off the left side of the hub.

- Put the wheel on blocks so that the disc does not touch the ground.
- KZ1000-M: Remove the bolts (4), and take the wheel cap and right-hand disc.
- Using a standard screwdriver, pry out the grease seal and remove the circlip on the right side.

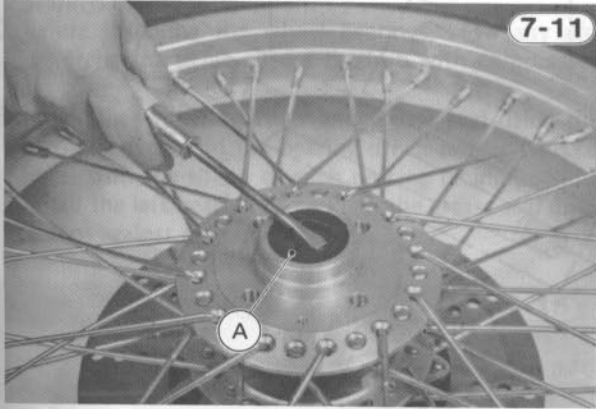

A. Grease Seal

- Remove the circlip on the left side, and remove the drive sleeve.

Front Hub (KZ1000-M)

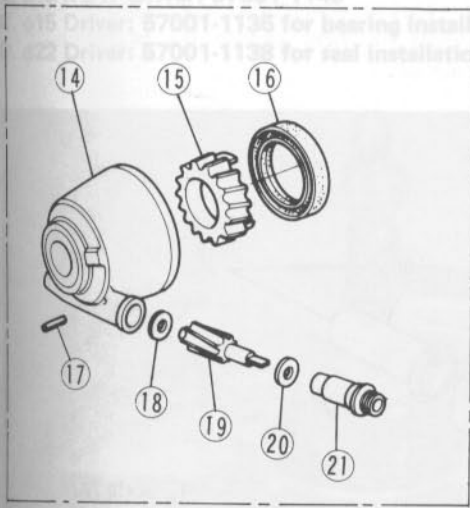

- Insert a metal rod into the hub from the left side of the hub, and remove the bearing on the right side by tapping evenly around the bearing inner race. The distance collar will come out with the bearing.

Wheel Bearing Removal

7-12

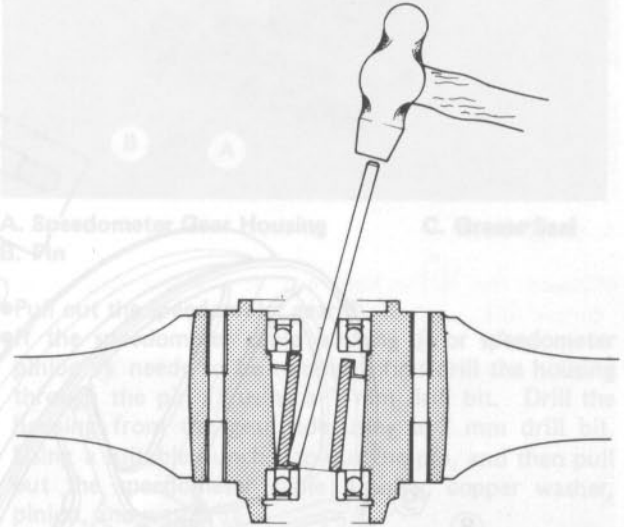

7-13

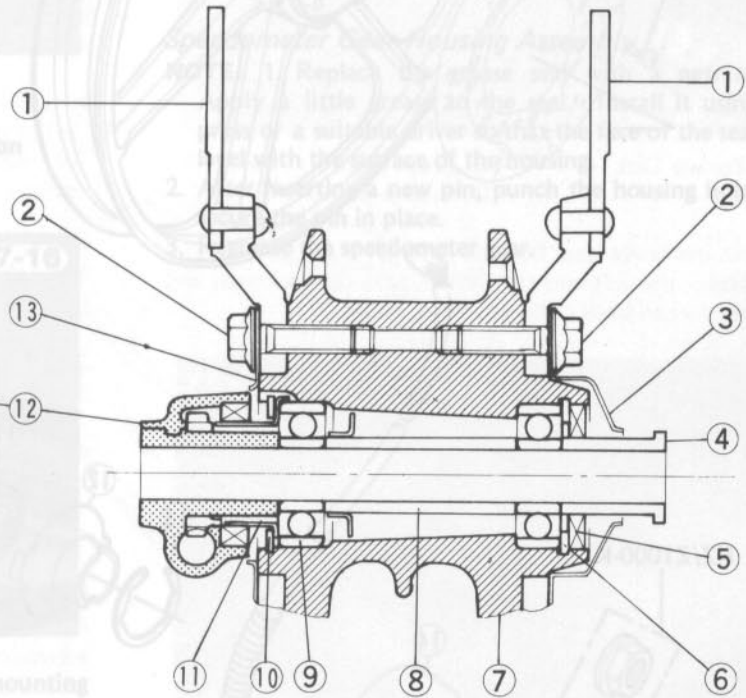

1. Brake Disc
2. Bolt
3. Wheel Cap
4. Collar
5. Grease Seal
6. Circlip
7. Front Hub
8. Distance Collar

9. Ball Bearing
10. Circlip
11. Drive Sleeve
12. Speedometer Gear Housing Assembly
13. Drive Sleeve Holding Plate
14. Gear Housing

15. Speedometer Gear
16. Grease Seal
17. Pin
18. Washer
19. Speedometer Pinion
20. Copper Washer
21. Bushing

Front Wheel (KZ/Z1000-J, K)

... wheel on blocks so that the disc does not touch...  
 ... distance collar will contact with the disc...  
 ... disc brake pads. This prevents the pad from...  
 ... moving out of their proper position, should the brake...  
 ... lever be operated accidentally.  
 KZ/Z1000-J: Remove one of the axle nut, pull out...  
 the front axle, and then the speed sensor off the front...  
 hub.

Installation:

Front Wheel and Speed Sensor

(Speedometer Gear Housing Installation)

NOTE: 1. Properly engage the...  
 speed sensor (KZ/Z1000-...  
 housing (KZ/Z1000-...

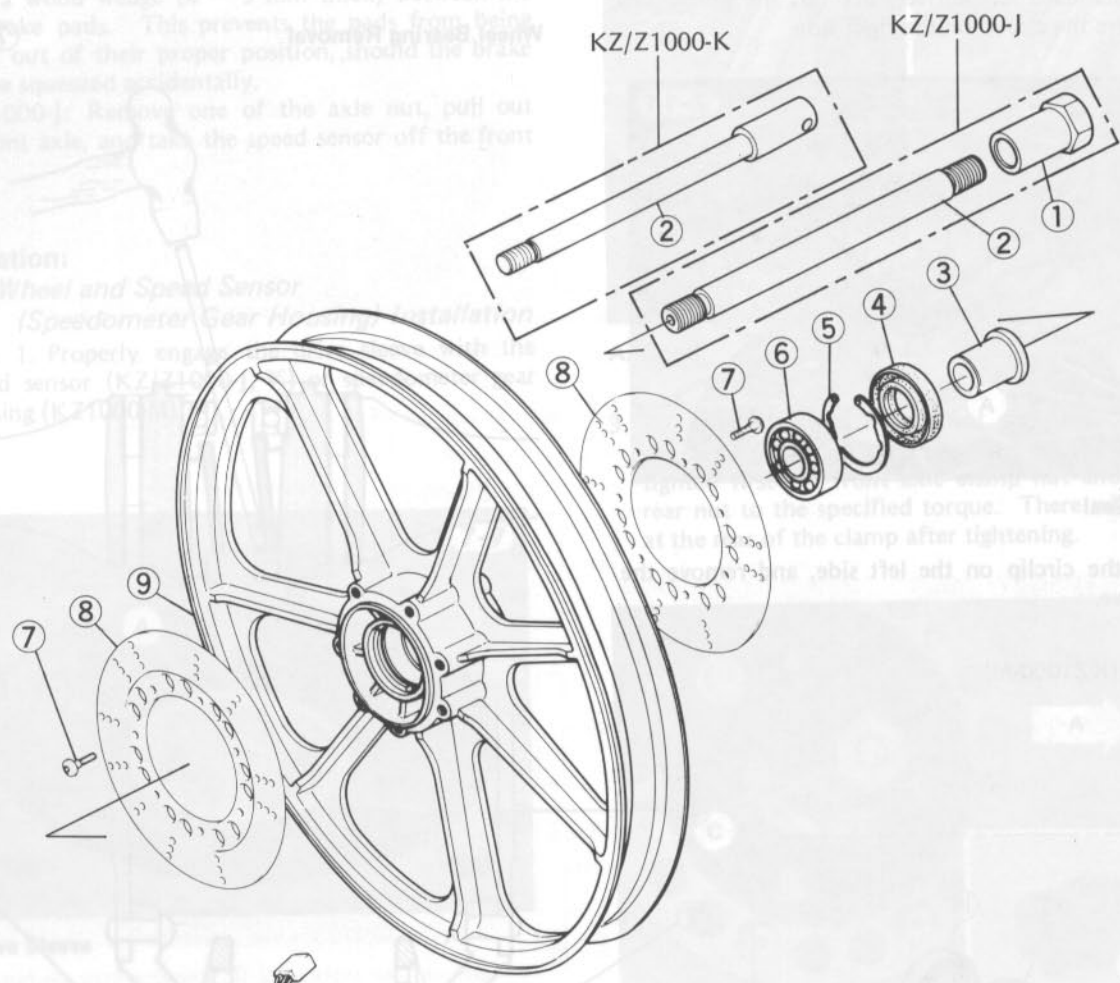

KZ/Z1000-K

KZ/Z1000-J

1. Axle Nut
2. Front Axle
3. Collar
4. Grease Seal
5. Circlip
6. Ball Bearing
7. Allen Bolt
8. Brake Disc
9. Front Wheel
10. Distance Collar
11. Ball Bearing
12. Drive Sleeve
13. Circlip
14. Speed Sensor

WARNING

1. Do not ride with...  
 The front brakes will not function...  
 application of the lever if this is...

6. KZ/Z1000-J, K: Check the...  
 Ball Bearing

... Ball Bearing  
 ... Circlip  
 ... Drive Sleeve  
 ... sensor or speedometer gear  
 ... of the hub.

- Insert the metal rod into the hub from the right side, and remove the other bearing.

### Front Hub Assembly

- NOTE:** 1. Inspect the wheel bearings, and replace them with new ones if they are damaged. Lubricate the bearings before installation.
2. Before installing the wheel bearings, blow any dirt or foreign particles out of the hub with compressed air.
  3. Install the wheel bearings and grease seal using the bearing drivers and the bearing driver holder (special tools) with the shield of each bearing facing outside. Install the left bearing first. Press the grease seal until it stops against the circlip.

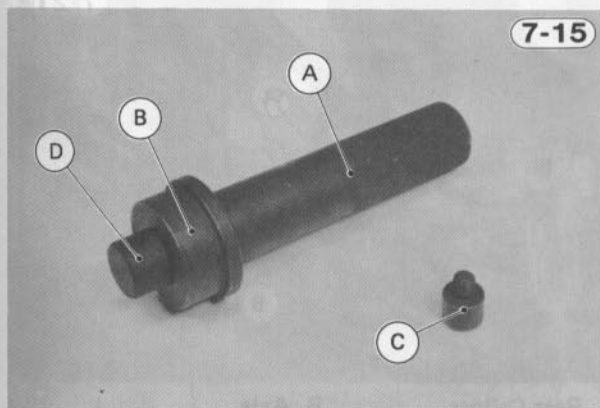

- A. Driver Holder: 57001-1132  
 B.  $\phi 42 \times \phi 47$  Driver: 57001-1145  
 C.  $\phi 15$  Driver: 57001-1135 for bearing installation  
 D.  $\phi 22$  Driver: 57001-1138 for seal installation

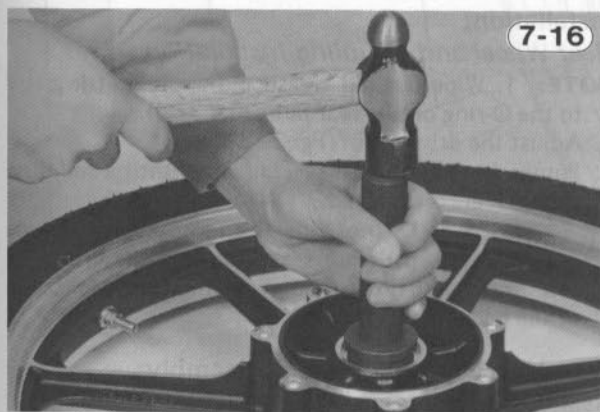

4. KZ1000-M: Tightening torque for the disc mounting bolts is 4.0 kg-m (29 ft-lbs). Observe the notes in the "Disc Installation" section (Pg. 7-15).
5. Completely clean off any grease that has gotten on either side of the disc with a high flash-point solvent. Do not use one which will leave an oily residue.

### Speedometer Gear Housing Disassembly and Assembly:

#### Speedometer Gear Housing Disassembly

- Pull out the grease seal (16) using a hook.

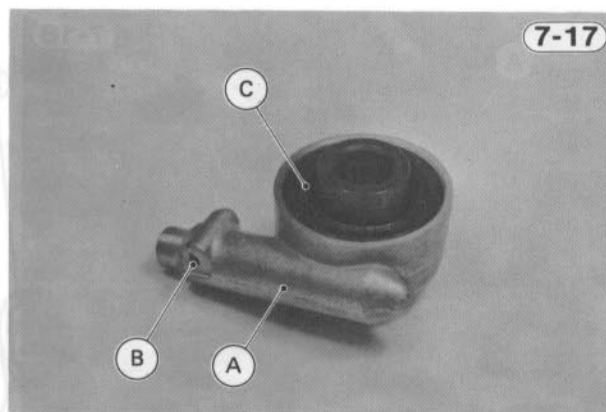

A. Speedometer Gear Housing  
B. Pin

C. Grease Seal

- Pull out the speedometer gear (15).
- If the speedometer cable bushing (21) or speedometer pinion (19) needs to be removed, first drill the housing through the pin (17) using a 1 mm drill bit. Drill the housing from the gear side using a 2 mm drill bit. Using a suitable punch, tap out the pin, and then pull out the speedometer cable bushing, copper washer, pinion, and washer (18).

**NOTE:** 1. It is recommended that the assembly be replaced rather than attempting to repair the components.

### Speedometer Gear Housing Assembly

- NOTE:** 1. Replace the grease seal with a new one. Apply a little grease to the seal. Install it using a press or a suitable driver so that the face of the seal is level with the surface of the housing.
2. After inserting a new pin, punch the housing hole to secure the pin in place.
  3. Regrease the speedometer gear.

## REAR WHEEL WHEEL COUPLING

### Removal:

#### Rear Wheel and Coupling Removal

- Put the motorcycle up on its center stand.
- Remove the bolts (2), and remove the drive chain guard.

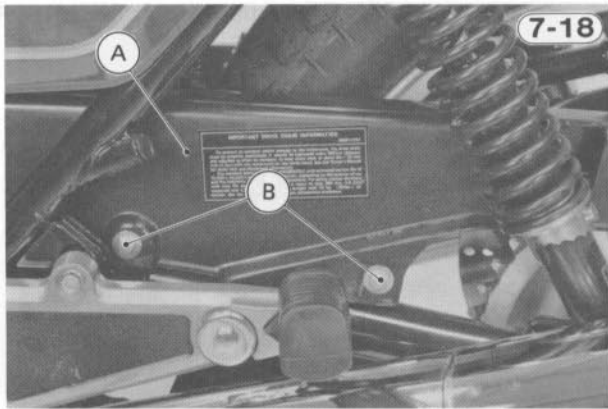

A. Chain Guard B. Bolts

- Loosen the self-locking nut at the rear end of the torque link.

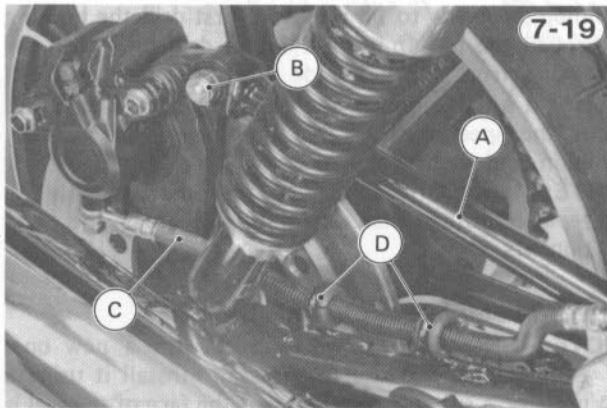

A. Torque Link B. Nut  
C. Brake Hose D. Guides

- Free the brake hose from its guides.
- Loosen the left and right chain adjuster locknuts, and fully loosen both chain adjusting bolts.

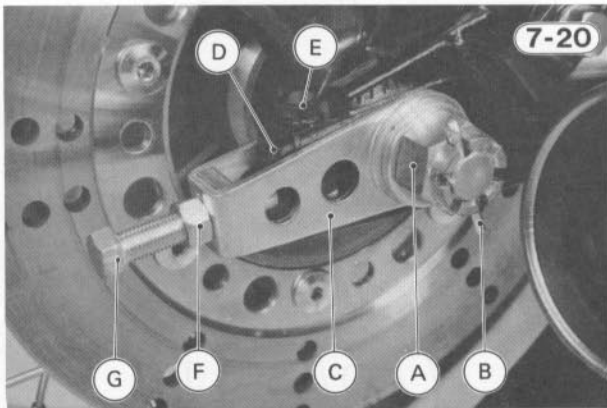

A. Axle Nut B. Cotter Pin  
C. Chain Adjuster D. Chain Adjuster Stop  
E. Stop Bolt F. Locknut  
G. Adjusting Bolt

- Remove the cotter pin, loosen the axle nut, and then push the wheel forward so that the chain can be easily removed from the rear sprocket.

- Remove the bolts and lockwashers (2 ea) and take out the chain adjuster stops.
- Remove the drive chain from the rear sprocket, and hang it to the left side of the swing arm.
- Pull the rear wheel together with the rear caliper toward the rear.
- Remove the axle nut and washer, pull off the rear axle, and remove the rear wheel along with the rear wheel coupling.

**CAUTION** 1. Do not lay the wheel on the ground with the disc facing down. This can damage or warp the disc. Place blocks under the wheel so the disc does not touch the ground.

- Run the axle through the swing arm and the caliper to prevent the caliper from dangling.

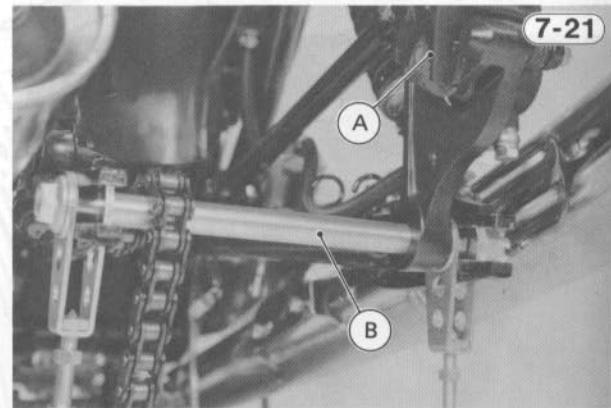

A. Rear Caliper B. Axle

- Insert a wood wedge (7 – 8 mm thick) between the disc brake pads. This prevents them from being moved out of their proper position, should the brake pedal be pushed accidentally.

### Installation:

#### Rear Wheel and Coupling Installation

- NOTE:**
- Wipe out old grease and apply a little grease to the O-ring on the rear hub (Fig. 7-25).
  - Adjust the drive chain (Pg. 2-13).
  - Pump the brake pedal several times until a full, firm pedal "feel" is obtained.

**WARNING** 1. Do not ride the motorcycle until the pads are seated against the disc. The rear brake will not function on the first application of the pedal if this is not done.

### Rear Hub Disassembly and Assembly:

#### Rear Hub Disassembly

- Remove the wheel coupling (10) and rubber damper (14) from the left side of the rear hub (18), and collar (23) from the right side.
- Remove the grease seal (21) using a standard screw driver, and remove the circlip (20).
- Insert a metal rod into the hub from the disc side, and remove the left side bearing (12) by tapping evenly around the bearing inner race. The distance collar (15) will come out with the bearing.
- Put the wheel on blocks so that the disc does not touch the ground.
- Insert the metal rod into the hub from the other side, and tap out the remaining bearing (19).

## Rear Wheel, Wheel Coupling

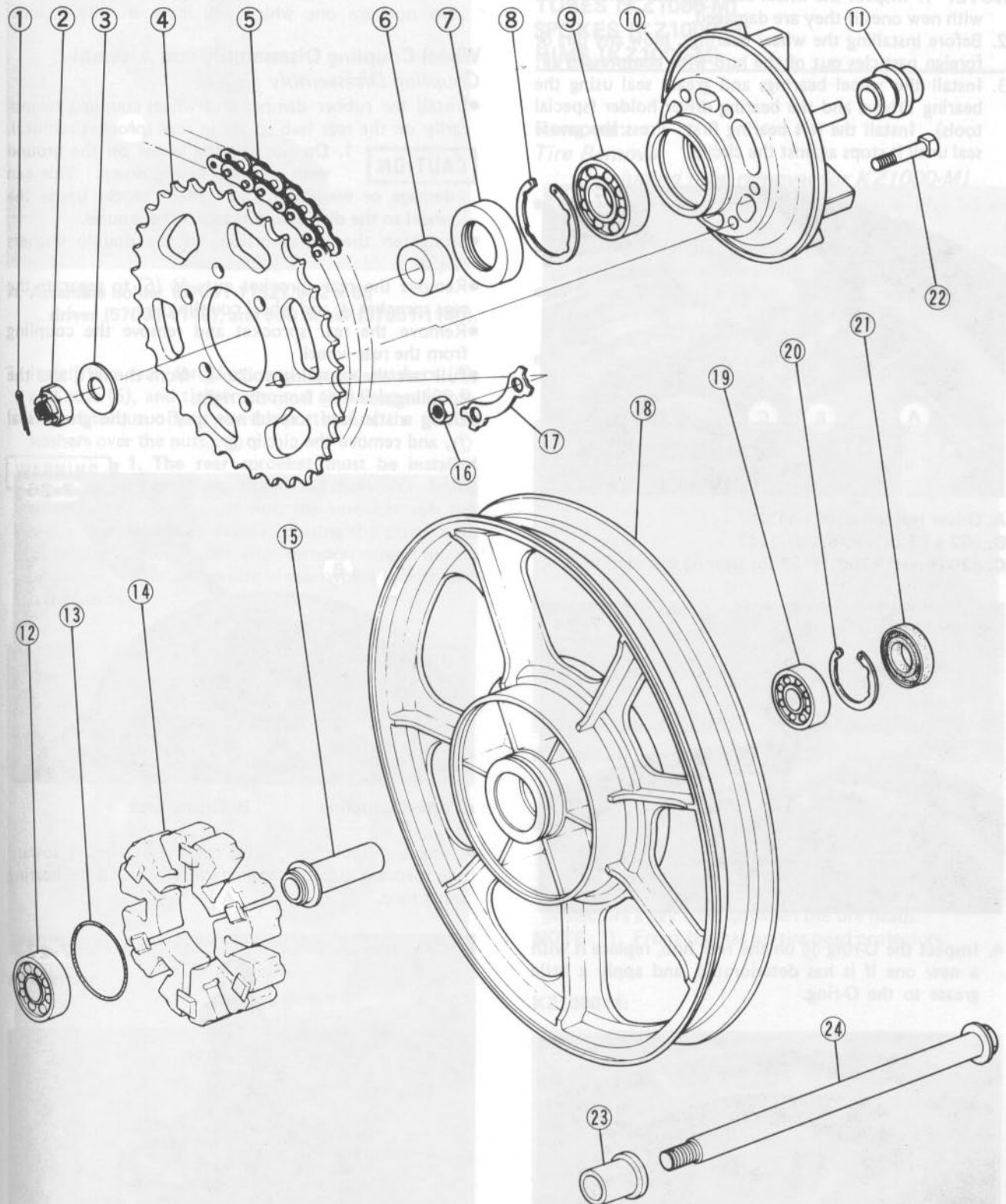

1. Cotter Pin
2. Axle Nut
3. Washer
4. Rear Sprocket
5. Drive Chain
6. Coupling Collar
7. Grease Seal

8. Circlip
9. Coupling Bearing
10. Wheel Coupling
11. Coupling Sleeve
12. Wheel Bearing
13. O-Ring
14. Rubber Damper

15. Distance Collar
16. Nut
17. Double Washer
18. Cast Wheel  
(KZ/Z1000-J, K)  
Wire Spoke Wheel  
(KZ1000-M)

19. Wheel Bearing
20. Circlip
21. Grease Seal
22. Bolt
23. Collar
24. Rear Axle



**Rear Hub Assembly**

- NOTE:** 1. Inspect the wheel bearings, and replace them with new ones if they are damaged.
2. Before installing the wheel bearings, blow any dirt or foreign particles out of the hub with compressed air.
3. Install the wheel bearings and grease seal using the bearing drivers and the bearing driver holder (special tools). Install the left bearing first. Press the grease seal until it stops against the circlip.

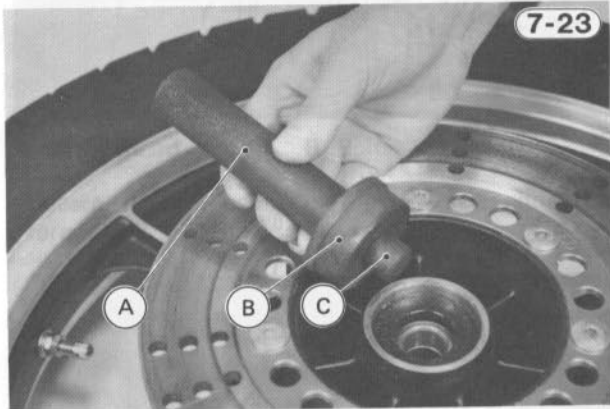

**A. Driver Holder: 57001-1132**  
**B.  $\phi 52 \times 55$  Driver: 57001-1147**  
**C.  $\phi 20$  Driver: 57001-1137 for bearing installation**

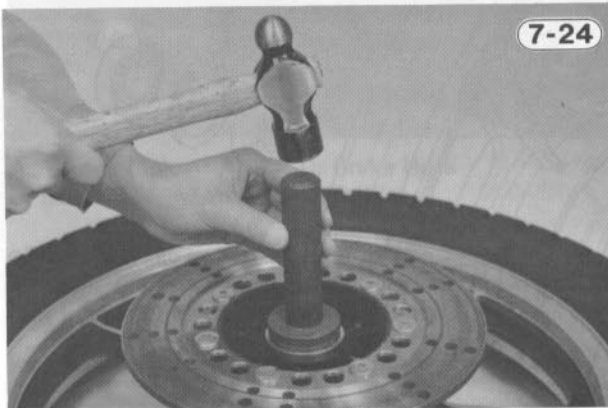

4. Inspect the O-ring (13) on the rear hub, replace it with a new one if it has deteriorated, and apply a little grease to the O-ring.

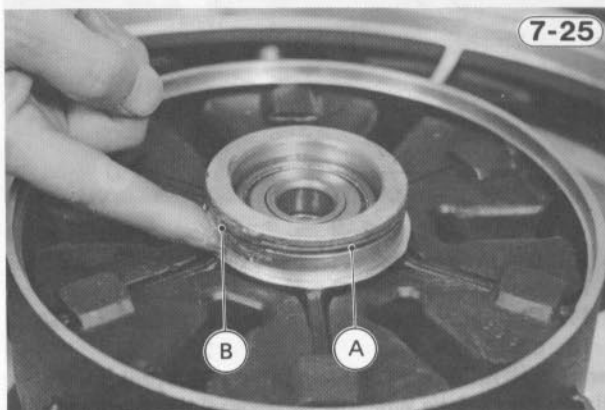

**A. O-Ring**      **B. Grease**

5. Completely clean off any grease that has gotten on either side of the disc with a high flash-point solvent. Do not use one which will leave an oily residue.

**Wheel Coupling Disassembly and Assembly:****Coupling Disassembly**

- Install the rubber damper and wheel coupling temporarily on the rear hub to aid in rear sprocket removal.

**CAUTION**

1. Do not lay the wheel on the ground with the disc facing down. This can damage or warp the disc. Place blocks under the wheel so the disc does not touch the ground.

- Straighten the bent portions of the double washers (17) (3).
- Remove the rear sprocket nuts (16) (6) to separate the rear sprocket (4) and wheel coupling (10).
- Remove the rear sprocket and remove the coupling from the rear wheel.
- Pull out the coupling collar (6) from the left, and the coupling sleeve (11) from the right.
- Using a standard screwdriver, pry out the grease seal (7), and remove the circlip (8).

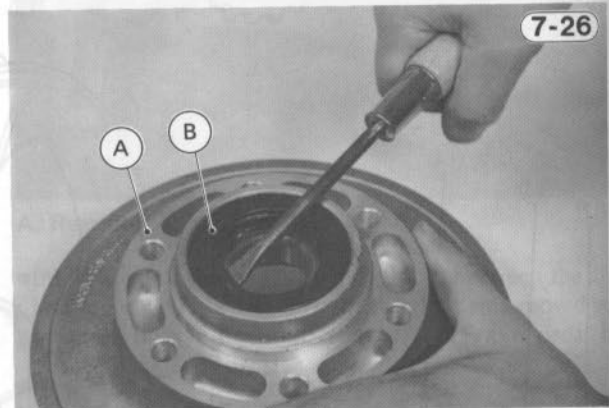

**A. Wheel Coupling**      **B. Grease Seal**

- Using a suitable tool, drive out the bearing (9) toward the sprocket side by tapping evenly around the bearing inner race.

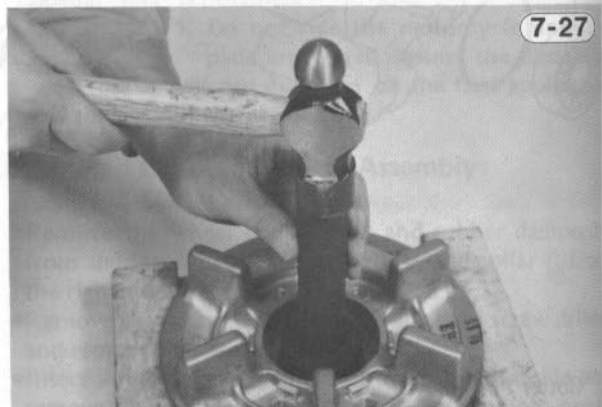
**Wheel Coupling Assembly**

- NOTE:** 1. Inspect the bearing, and replace if necessary. Lubricate it before installation.
2. Install the bearing and grease seal using the bearing drivers and the bearing driver holder (special tools).

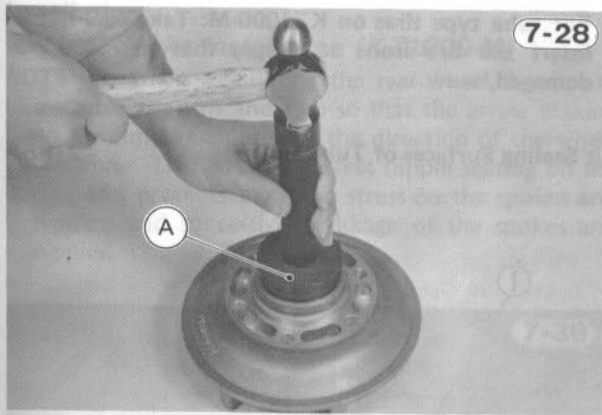

A. Assemble holder (57001-1132),  $\phi 62 \times 68$  driver (57001-1148), and  $\phi 30$  driver (57001-1140).

3. Install the rear sprocket, new double washers (3), and nuts (6), and tighten the nut to 4.0 kg-m (29 ft-lbs) of torque. Bend the tab portions of the double washers over the nuts.

**WARNING** 1. The rear sprocket must be installed with the chamfered hole side facing toward the coupling. If not, the sprocket will not seat on the coupling evenly, causing the drive chain to be thrown off by excessive sprocket runout during operation. This can result in rear wheel lockup and loss of control.

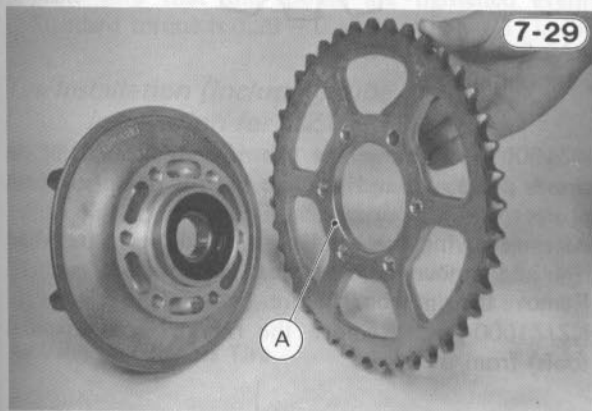

A. Chamfer

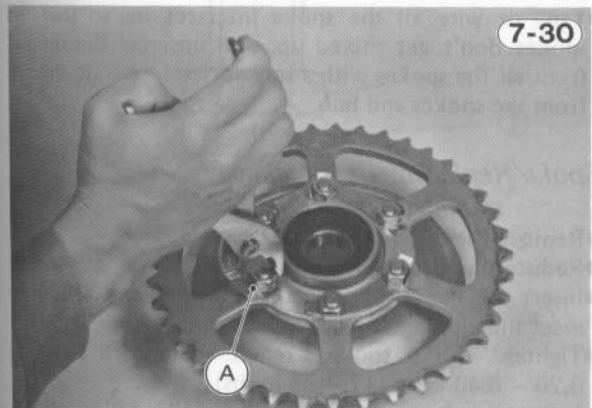

A. Bend the tab portions.

## TIRES

### TUBES (KZ1000-M)

### SPOKES (KZ1000-M)

### RIMS (KZ1000-M)

#### Removal:

##### Tire Removal

(including tube removal for KZ1000-M)

- Remove the wheel from the motorcycle (Pg. 7-3 or 7-7).
- Remove the collar(s), speed sensor or speedometer gear housing, and remove the disc(s) from the hub.
- To maintain wheel balance, mark the valve stem position on the tire with chalk so that the tire will be reinstalled in the same position.
- Take out the valve core to let out the air.

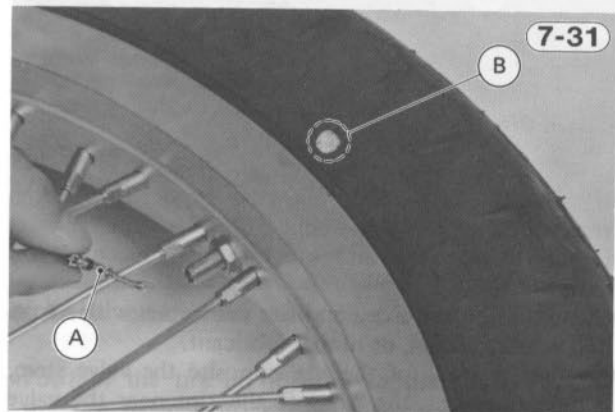

A. Unscrew valve core. B. Mark valve stem position.

- KZ1000-M: Remove the valve stem nut, and fully loosen the two bead protector nuts if the rear tire is to be removed.
  - KZ1000-M: Use a rubber mallet to break the bead protectors away from between the tire beads.
- NOTE:** 1. Front tire has no tire bead protectors.

#### KZ1000-M:

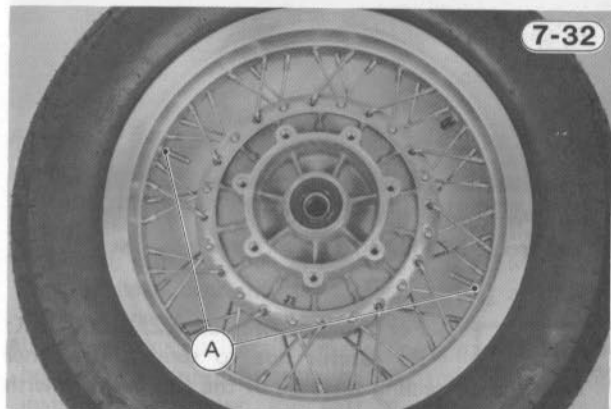

A. Bead Protector Nuts

- Lubricate the tire beads and rim flanges on both sides with a soap and water solution, or rubber lubricant. This helps the tire beads slip off the rim flanges.

**CAUTION**

1. Never lubricate with mineral oil (engine oil) or gasoline because they will cause deterioration of the tire.

- Break the beads away from both sides of the rim with the bead breaker (special tool).

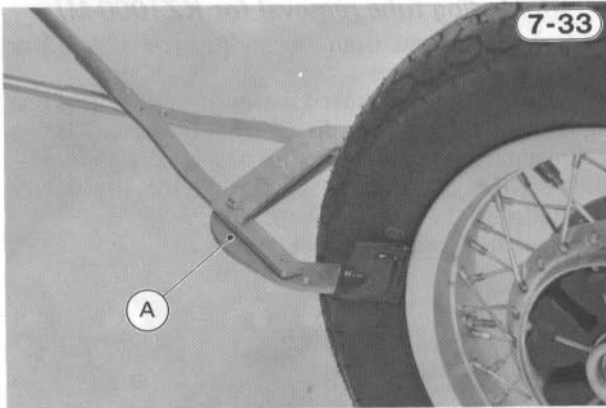

A. Bead Breaker: 57001-1072

- KZ/Z1000-J, K: Install the rim protectors (special tools) around the valve stem. To prevent rim damage, be sure to place the rim protectors at any place the tire irons are applied.
- Lubricate the tire irons and rim protectors with a soap and water solution, or rubber lubricant.
- Step on the side of the tire opposite the valve stem, and start prying the tire off the rim near the valve stem with tire irons (special tools).

**NOTE:** 1. For easier removal, always position the tire bead opposite the valve stem in the rim well, and pry the tire bead a little at a time.

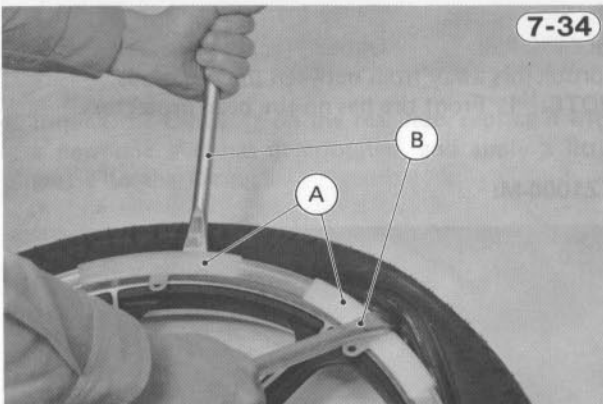

A. Rim Protectors: 57001-1063  
B. Tire Irons: 57001-1073

**CAUTION**

1. For tubeless tires on KZ/Z1000-J, K: Be careful not to scratch the inner liner and air sealing surfaces of the rim and tire with the tire irons. A scratched inner liner or sealing surface may allow air to leak.

2. For tube type tires on KZ1000-M: Take care not to insert the tire irons so deeply that the tube gets damaged.

## Air Sealing Surfaces of Tubeless Tires

7-35

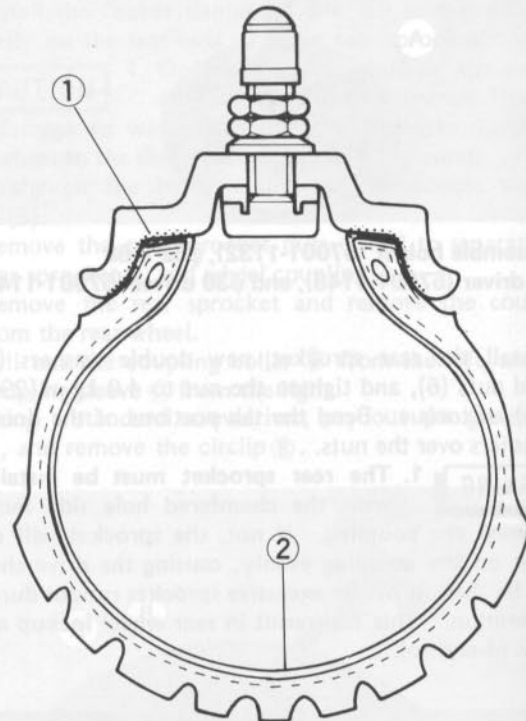

1. Air Sealing Surfaces
2. Inner Liner

- KZ1000-M: Remove the tube when one side of the tire is pried off, and pry the tire off one of the bead protectors.
- After removing the bead on one side, turn the wheel over and remove the other side.
- Remove the rim from the tire.
- KZ/Z1000-J, K: Remove the rim protectors (special tools) from the rim.

*Rim and Spoke Removal (KZ1000-M)*

- Remove the bead protectors (rear wheel only) and the rubber band.
- Tape or wire all the spoke intersections so that the spokes don't get mixed up, and unscrew the nipples from all the spokes with a screwdriver; separate the rim from the spokes and hub.

*Spoke Replacement (breakage replacement, KZ1000-M)*

- Remove the disc (Pg. 7-14).
- Reduce the tire air pressure by a small amount.
- Insert the new spoke through the hub, and bend it to meet the nipple.
- Tighten with a spoke wrench. Standard torque is 0.20 – 0.40 kg-m (17 – 35 in-lbs).
- Inflate the tire to standard pressure (Pg. 4-3).
- Install the disc (Pg. 7-15).

**Installation:****Rim and Spoke Installation (KZ1000-M)**

**NOTE:** 1. When assembling the rear wheel, be sure to assemble the rim and hub so that the arrow making on the rim coincides with the direction of the wheel rotation. This ensures perfect nipple seating on the rim, and prevents excessive stress on the spokes and nipples, and successive breakage of the spokes and nipples.

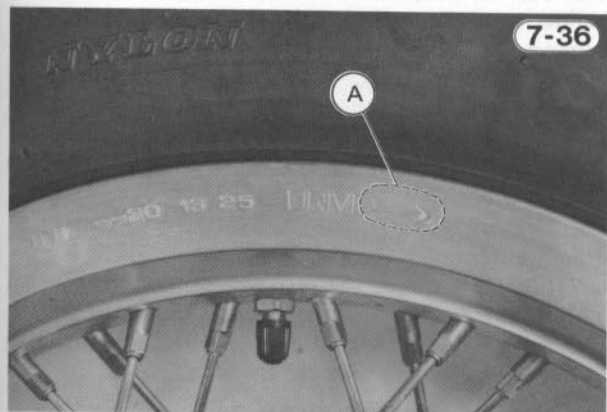

**A. Arrow mark on rim shows direction of rotation.**

2. Tighten the spokes evenly so that the radial (out from the axle) and axial (side to side) runouts are less than the service limit (Pg. 2-23).
3. Make sure that the spokes are tightened evenly. Standard torque is 0.20 – 0.40 kg-m (17 – 35 in-lbs).

**Tire Installation (including tube installation for KZ1000-M)**

- KZ/Z1000-J, K: Clean the sealing surfaces of the rim and tire, and smooth the sealing surfaces of the rim with a fine emery cloth if necessary.
- KZ/Z1000-J, K: Replace the valve with a new one. Tighten the mounting nut and locknut to 0.15 kg-m (13 in-lbs) of torque.

**Air Valve of Tubeless Tire**

7-37

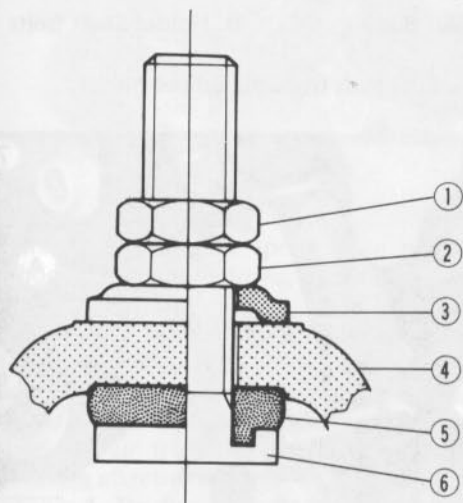

- |            |               |               |
|------------|---------------|---------------|
| 1. Locknut | 3. Washer     | 5. Grommet    |
| 2. Nut     | 4. Cast Wheel | 6. Valve Stem |

- KZ1000-M: Put just enough air in the tube to keep it from getting caught between the tire and rim. Too much air makes fitting difficult, and too little will make the tube more liable to be pinched by the irons. Dust the tube and inside the tire with talcum powder, and insert the tube into the tire now, even if the tire was completely removed from the rim. Insert the valve stem into the rim, and screw the nut on loosely.
- Apply a soap and water solution, or rubber lubricant to the rim flanges, rim protectors, tire beads, and tire irons.
- Check the tire rotation mark on the rear tire and install it on the rim accordingly.

**NOTE:** 1. The direction of the tire rotation is shown by an arrow on the tire sidewall.

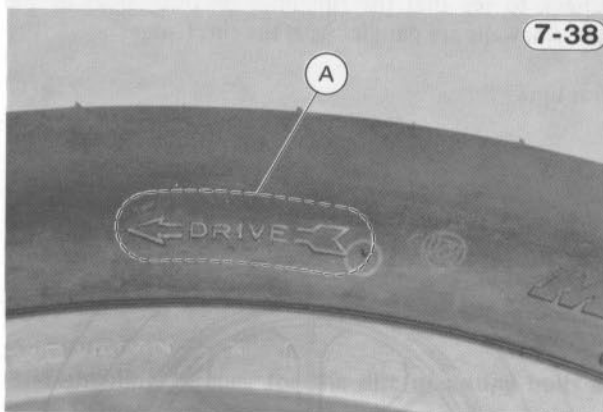

**A. Arrow mark on tire shows direction of rotation.**

- Position the tire on the rim so that the valve is at the tire balance mark (the chalk mark made during removal, or the yellow paint mark on a new tire).

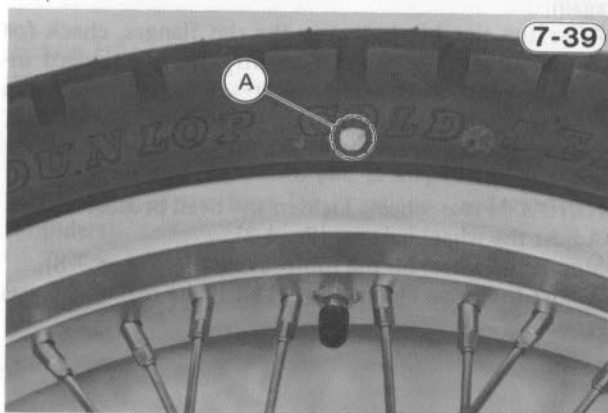

**A. Balance Mark**

- Fit the rim protectors on the rim flange near the valve stem.
- By hand, slide as much as possible of the lower side of the tire bead over the rim flange, starting at the side opposite the valve.
- Use tire irons to install the remaining part of the tire bead which cannot be installed by hand. For easy tire installation, position the part of the bead which is already over the rim flange in the rim well.

- Install the other side of the tire bead onto the rim in the same manner.
- KZ1000-M: Check that the tube is not pinched between the tire and rim.
- Lubricate the tire beads and rim flanges with a soap and water solution or rubber lubricant to help seat the tire beads in the sealing surfaces of the rim while inflating the tire.
- Center the rim in the tire beads, and inflate the tire with compressed air until the tire beads seat in the sealing surfaces.

**WARNING** 1. Be sure to install the valve core whenever inflating the tire, and do not inflate the tire to more than 4.0 kg/cm<sup>2</sup> (400 kPa, 57 psi). Overinflation can explode the tire with possibility of injury and loss of life.

- Check to see that the rim lines on both sides of the tire sidewalls are parallel with the rim flanges.

#### Rim Line

7-40

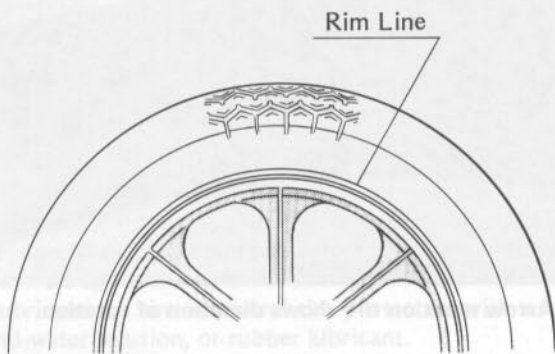

- If the rim lines and tire sidewall lines are not parallel, remove the valve core. Lubricate the rim flanges and tire beads. Install the valve core and inflate the tire again.
- After the tire beads seat in the rim flanges, check for air leaks. Inflate the tire slightly above standard inflation. Use a soap and water solution or submerge it, and check for bubbles that would indicate leakage.
- Adjust the air pressure to the specified pressure (Pg. 4-3).
- KZ1000-M rear wheel: Tighten the bead protector nuts.
- Adjust the wheel balance (Pg. 4-2).
- Mount the wheel on the motorcycle (Pg. 7-4 or 7-8).
- Adjust the drive chain (Pg. 2-13), if the rear wheel was removed.

#### BRAKE HOSES DISCS PADS

**NOTE:** 1. Photographs and detailed descriptions for the front brake have been included in this section.

2. Unless otherwise noted, the procedures for the rear brake are the same as those for the front brake.
2. Observe the WARNING on Pg. 2-16 for general disc brake information.

#### Removal:

##### Brake Hose Removal

- Pump the brake fluid out of the line as explained in the *Changing Brake Fluid* section (Pg. 2-16).
- Remove the banjo bolts at the hose joint and at the caliper or master cylinder (depending on the hose), and remove the brake hose. There is a flat washer on each side of the hose fitting.
- Rear brake hose between the rear master cylinder and the reservoir: Loosen the clamps at both end of the hose, and pull off the hose.

##### Disc Removal (each disc)

- Remove the wheel (Pg. 7-3 or 7-7).
- KZ1000-M: Remove the disc mounting bolts (4), and remove the drive sleeve holding plate and disc.
- Other than KZ1000-M: Remove the disc mounting Allen bolts (7), and take off the disc.

##### Pad Removal (for each caliper)

- Remove the caliper holder shaft bolts (2), and lift the caliper body off the caliper holder.

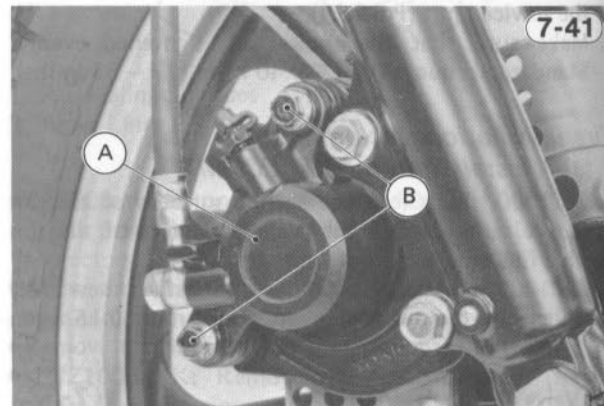

A. Caliper Body

B. Holder Shaft Bolts

- Remove the pads from the caliper holder.

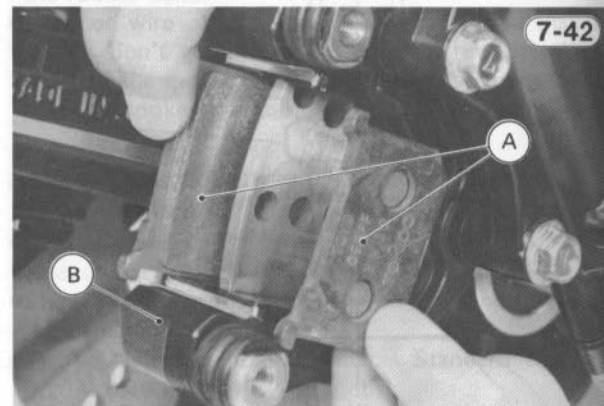

A. Pads

B. Caliper Holder

**Installation:****Pad Installation (for each caliper)**

- Remove the bleed valve cap on the caliper, attach a clear plastic hose to the bleed valve, and run the other end of the hose into a container.
- Open (loosen) the valve slightly, push the piston in by hand as far as it will go, and then close (tighten) the valve. Wipe up any spilled fluid, and recap the bleed valve. The bleed valve must be tightened to 0.80 kg-m (69 in-lbs) of torque.

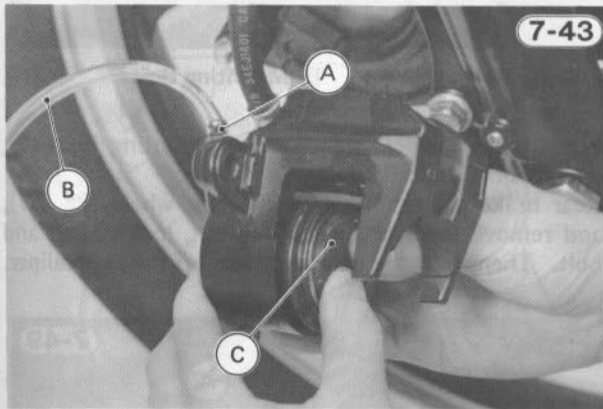

A. Bleed Valve      B. Hose      C. Piston

- Check that the sliders (2) are properly installed in the caliper holder.
- Fit the pads against the disc in the caliper holder.

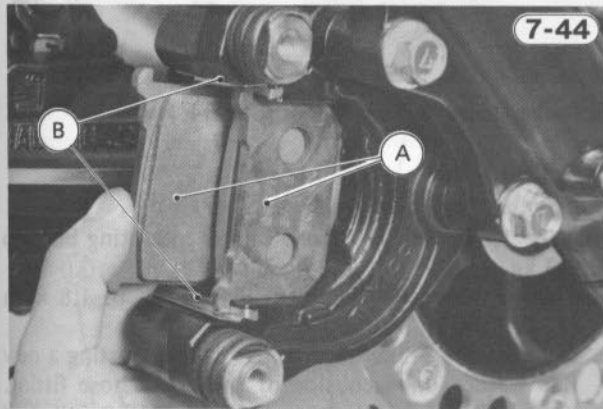

A. Pads      B. Sliders

- Check that the anti-rattle spring is in place in the caliper body. If it was removed, install it to the caliper as shown in Fig. 7-53.
- Install the caliper, and tighten the caliper holder shaft bolts to 1.8 kg-m (13.0 ft-lbs) of torque.
- Since some brake fluid was lost when the bleed valve was opened, check the fluid level in the master cylinder and bleed the air from the brake system (Pg. 2-17).
- Check braking effectiveness.

**WARNING**

1. Do not attempt to drive the motorcycle until a full brake lever or pedal is obtained by pumping the brake lever or pedal until

the pads are against the disc. The brake will not function on the first application of the lever or pedal if this is not done.

**Disc Installation (each disc)**

- NOTE:**
1. Clean the disc and wheel hub mating surfaces of any dirt and foreign particle.
  2. Mount the brake disc on the wheel so that the marked side faces out.

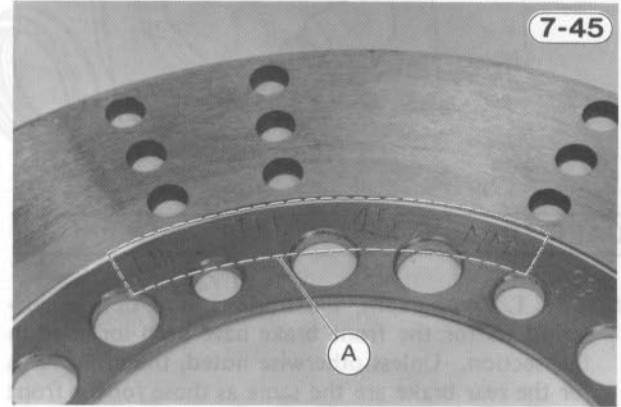

A. Marking

3. Tightening torques for the disc mounting bolts are as follows:  
 Front disc of KZ/Z1000-J, K: 2.3 kg-m (16.5 ft-lbs)  
 Front disc of KZ1000-M: 4.0 kg-m (29 ft-lbs)  
 Rear disc: 2.3 kg-m (16.5 ft-lbs)
4. After installing the disc, check the disc runout (Pg. 4-12).
5. Check braking effectiveness.

**Brake Hose Installation**

- NOTE:**
1. Discard the used flat washers, and install a new flat washer on each side of the brake hose fittings.
  2. Fit the metal pipe into the U-shaped notch (if it is provided in the hose joint, calipers, and master cylinders).

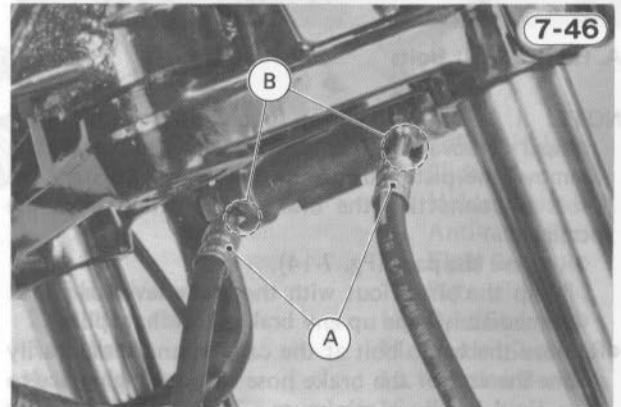

A. Metal Pipe      B. U-Shaped Notch

3. Tightening torque for the banjo bolts is 2.5 kg-m (18.0 ft-lbs).
4. Tighten the clamp screws (2) for the rear brake reservoir hose to 0.10 kg-m (9 in-lbs) of torque.
5. Fill the reservoir with fresh brake fluid, and bleed the brake line (Pg. 2-17).
6. Check braking effectiveness.

## CALIPERS

- NOTE:** 1. Photographs, illustrations, and detailed descriptions for the front brake have been included in this section. Unless otherwise noted, the procedures for the rear brake are the same as those for the front brake.
2. Observe the WARNING on Pg. 2-16 for general disc brake information.

### Removal:

#### Caliper Removal (each caliper)

- If the caliper is to be disassembled, loosen the caliper holder shaft bolts (2).

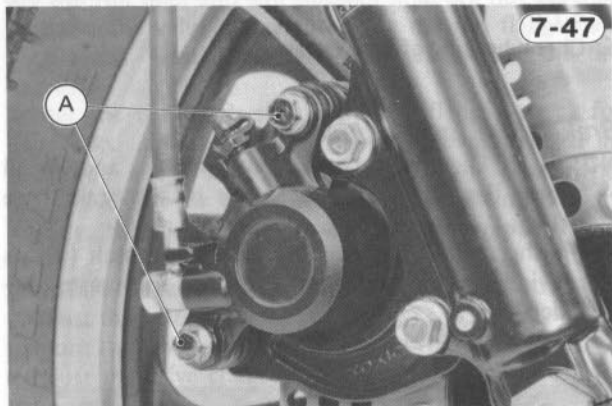

A. Holder Shaft Bolts

**NOTE:** 1. If the caliper is to be disassembled after caliper removal and compressed air is not available, remove the piston using the following two steps before disconnecting the brake hose fitting from the caliper.

- Remove the pads (Pg. 7-14).
- Pump the piston out with the brake lever or pedal.
- Immediately wipe up any brake fluid that spills.
- Remove the banjo bolt at the caliper, and temporarily secure the end of the brake hose to some high place to keep fluid loss to a minimum. There is a flat washer on each side of the hose fitting.

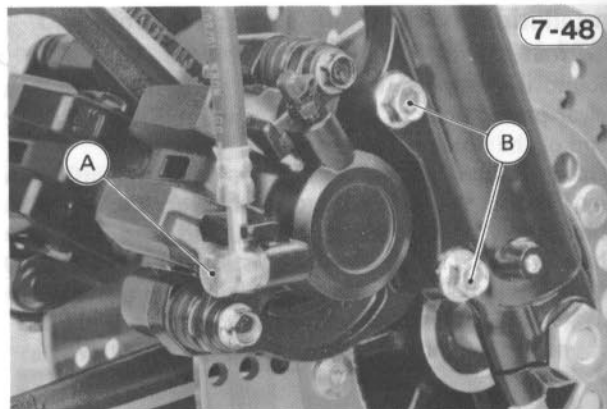

A. Banjo Bolt

B. Mounting Bolts

- Front brake caliper: Remove the mounting bolts (2), and take off the caliper.
- Rear brake caliper: Remove the rear wheel (Pg. 7-7), and remove the rear torque link nut, lockwasher, and bolt. Then, pull the axle and take off the rear caliper.

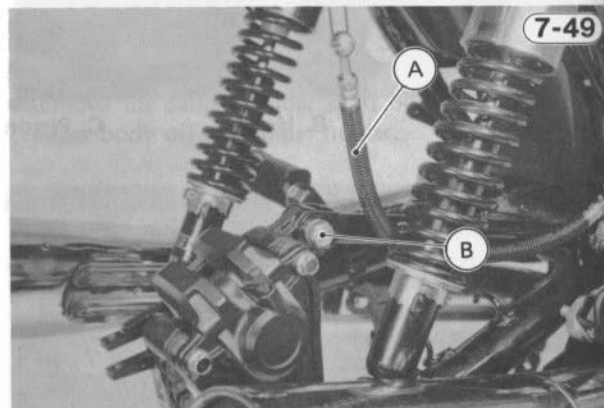

A. Brake Hose

B. Torque Link Nut

### Installation:

#### Caliper Installation (each caliper)

- NOTE:** 1. Tighten the front caliper mounting bolts to 3.3 kg-m (24 ft-lbs) of torque.
2. Tighten the caliper holder shaft bolts to 1.8 kg-m (13.0 ft-lbs) of torque.
  3. Connect the brake hose to the caliper putting a new flat washer on each side of the brake hose fitting. Tighten the banjo bolt to 2.5 kg-m (18.0 ft-lbs) of torque.
  4. Check the fluid level in the master cylinder, and bleed the brake line (Pg. 2-17).
  5. Check braking effectiveness.

### Caliper Disassembly and Assembly:

#### Caliper Disassembly (each caliper)

- Remove the caliper holder shaft bolts (9) (2), and pull out the caliper holder (7) or (17) and the pads (16) (2).
- Remove the holder shafts (4) and (14) with the dust covers (5). There is the friction boot (15) on the shaft (14) that diameter is smaller than the other.
- Remove the anti-rattle spring (10).
- Remove the dust seal (13) around the piston (12).

Front and Rear Calipers

(1) Front Caliper

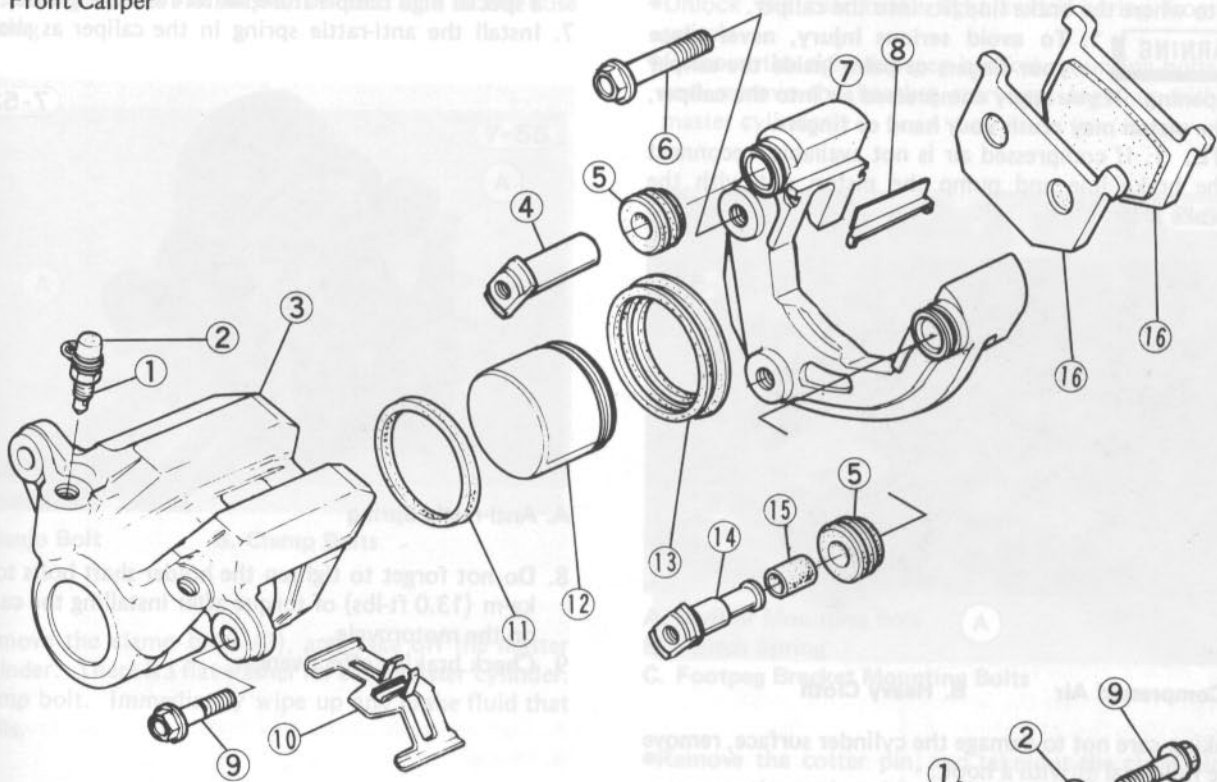

Rear Master Cylinder Removal

Remove the banjo bolt to disconnect the brake hose from the master cylinder. There is a flat washer on the end of the hose fitting. Immediately wipe up any spills.

Loosen the clamp screw, pull the reservoir hose and off the master cylinder. Do not disconnect the reservoir from the end of the reservoir.

(2) Rear Caliper

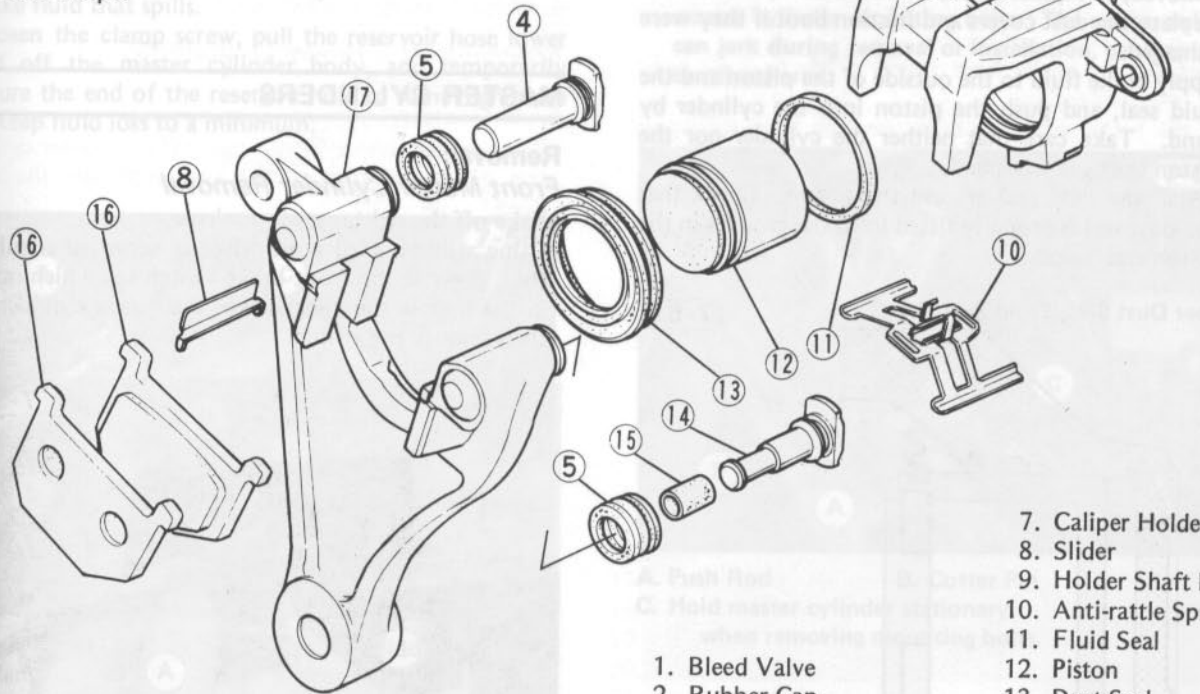

- 1. Bleed Valve
- 2. Rubber Cap
- 3. Caliper
- 4. Holder Shaft
- 5. Dust Cover
- 6. Mounting Bolt
- 7. Caliper Holder
- 8. Slider
- 9. Holder Shaft Bolt
- 10. Anti-rattle Spring
- 11. Fluid Seal
- 12. Piston
- 13. Dust Seal
- 14. Holder Shaft
- 15. Friction Boot
- 16. Pad
- 17. Caliper Holder



●Cover the caliper opening with a clean, heavy cloth, and remove the piston by lightly applying compressed air to where the brake line fits into the caliper.

**WARNING** 1. To avoid serious injury, never place your fingers or palm inside the caliper opening. If you apply compressed air into the caliper, the piston may crush your hand or fingers.

**NOTE:** 1. If compressed air is not available, reconnect the brake line and pump the piston out with the brake lever.

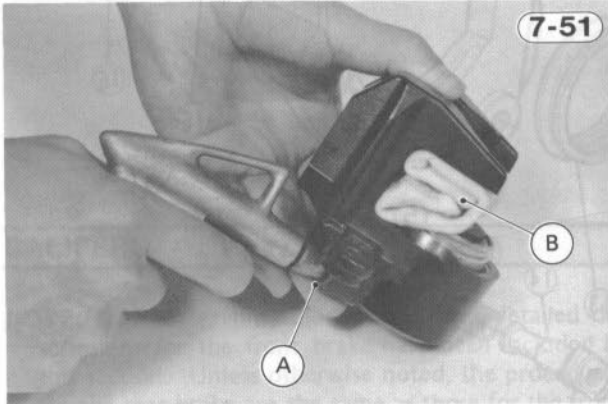

A. Compressed Air B. Heavy Cloth

●Taking care not to damage the cylinder surface, remove the fluid seal ① with a hook.

**Caliper Assembly (each caliper)**

- NOTE:** 1. Clean the caliper parts with brake fluid or alcohol.  
 2. It is recommended that the fluid seal, which is removed, be replaced with a new one.  
 3. Replace the dust covers and friction boot if they were damaged.  
 4. Apply brake fluid to the outside of the piston and the fluid seal, and push the piston into the cylinder by hand. Take care that neither the cylinder nor the piston skirt get scratched.  
 5. Install the dust seal around the piston. Check that the dust seal is properly fitted in to the grooves in the piston and caliper.

**Caliper Dust Seal, Fluid Seal**

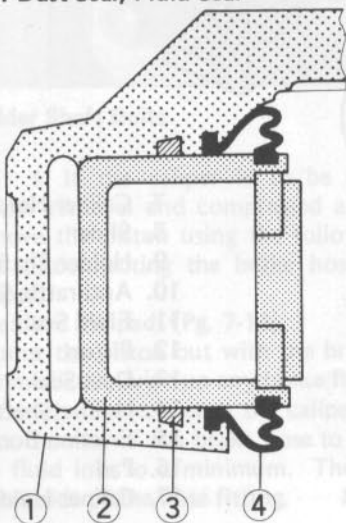

1. Caliper
2. Piston
3. Fluid Seal
4. Dust Seal

6. Apply a thin coat of PBC (Poly Butyl Cuprysil) grease to the caliper holder shafts and holder holes. (PBC is a special high temperature, water-resistant grease).
7. Install the anti-rattle spring in the caliper as shown.



A. Anti-rattle Spring

8. Do not forget to tighten the holder shaft bolts to 1.8 kg-m (13.0 ft-lbs) of torque after installing the caliper on the motorcycle.
9. Check braking effectiveness.

**MASTER CYLINDERS**

**Removal:**

**Front Master Cylinder Removal**

- Take off the right rear view mirror.
- Using a thin-bladed screwdriver or some other suitable tool, press in the front brake switch tab which catches in the hole in the underside of the master cylinder, and then remove the switch.

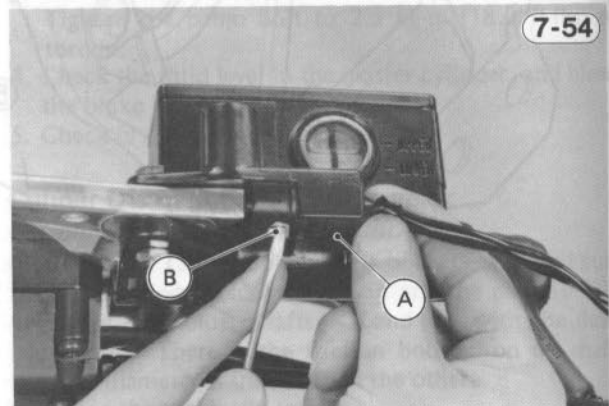

A. Front Brake Switch B. Switch Tab

- Pull back the dust cover, and remove the banjo bolt to disconnect the upper brake hose from the master cylinder. There is a flat washer on each side of the hose fitting.

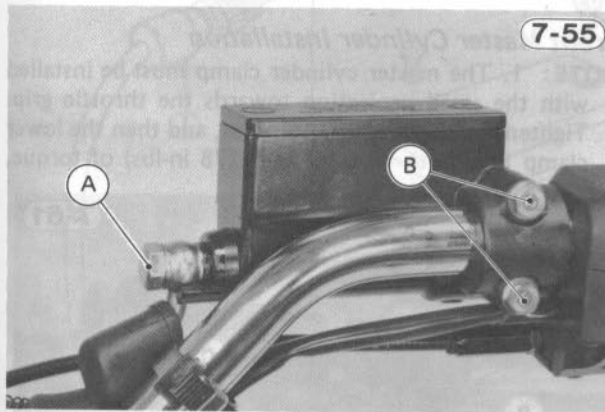

A. Banjo Bolt      B. Clamp Bolts

- Remove the clamp bolts (2), and take off the master cylinder. There is a flat washer for each master cylinder clamp bolt. Immediately wipe up any brake fluid that spills.

#### Rear Master Cylinder Removal

- Remove the banjo bolt to disconnect the brake hose from the master cylinder. There is a flat washer on each side of the hose fitting. Immediately wipe up any brake fluid that spills.
- Loosen the clamp screw, pull the reservoir hose lower end off the master cylinder body, and temporarily secure the end of the reservoir hose to some high place to keep fluid loss to a minimum.

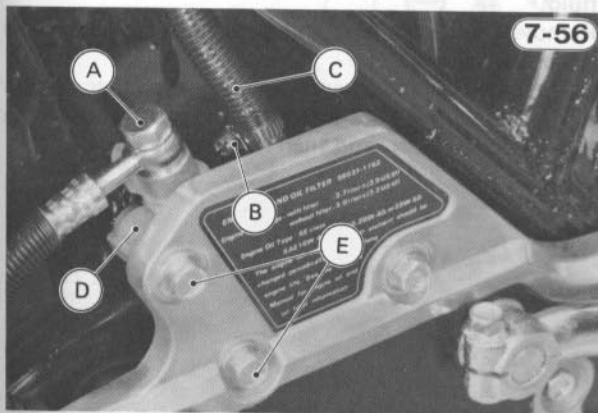

A. Banjo Bolt      D. Master Cylinder  
B. Clamp      E. Master Cylinder  
C. Reservoir Hose      Mounting Bolts

- Loosen the master cylinder mounting bolts (2).

- Remove the muffler mounting bolt at the right footpeg bracket.
- Unlock the rear brake light switch spring from the switch.
- Remove the right footpeg bracket mounting bolts (3), and remove the bracket rearwards together with the master cylinder.

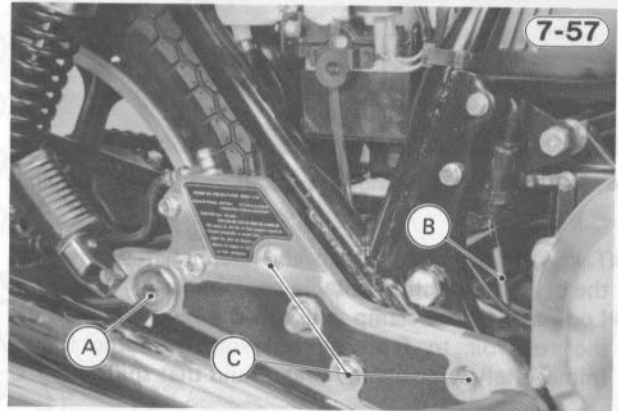

A. Muffler Mounting Bolt  
B. Switch Spring  
C. Footpeg Bracket Mounting Bolts

- Remove the cotter pin, and take out the clevis pin to separate the push rod from the lever.
- Remove the master cylinder mounting bolts (2), and remove the master cylinder.

**WARNING** 1. The master cylinder is under spring tension. Hold the master cylinder stationary on the footpeg bracket when removing master cylinder mounting bolts. The master cylinder can jerk during removal or installation, causing injury or other harm.

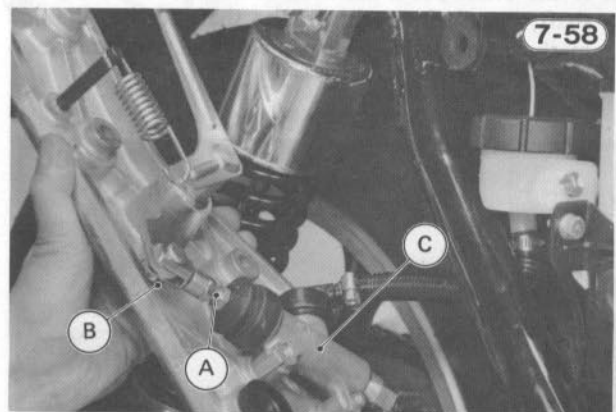

A. Push Rod      B. Cotter Pin  
C. Hold master cylinder stationary when removing mounting bolts.

#### Rear Brake Reservoir Removal

- Pull off the right side cover.
- Remove the rear brake reservoir mounting bolt, and take the reservoir off the frame.

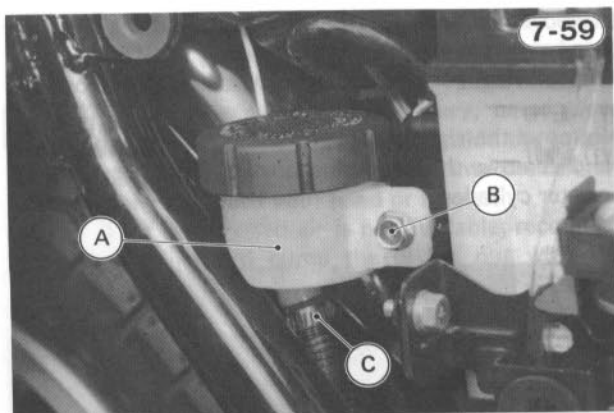

A. Reservoir B. Mounting Bolt C. Hose Clamp

- Take off the reservoir cap and diaphragm and empty the brake fluid into a suitable container.
- Loosen the hose clamp and pull the reservoir hose off the reservoir to free the reservoir from the frame. Immediately wipe up any brake fluid that spills.

#### Installation:

##### Rear Brake Reservoir Installation

- NOTE:** 1. Tighten the brake hose clamp screw to 0.10 kg-m (9 in-lbs) of torque.
2. Fill the reservoir with fresh brake fluid, and bleed the brake line (Pg. 2-17).
  3. Check braking effectiveness.

##### Rear Master Cylinder Installation

- NOTE:** 1. Use a new flat washer on each side of the brake hose fitting, and tighten the banjo bolt to 2.5 kg-m (18.0 ft-lbs) of torque.
2. Tighten the brake hose clamp screw to 0.10 kg-m (9 in-lbs) of torque.
  3. If the brake pedal has been removed from the pedal shaft, install the pedal on the shaft so that the line mark on the pedal is aligned with the punch mark on the shaft.

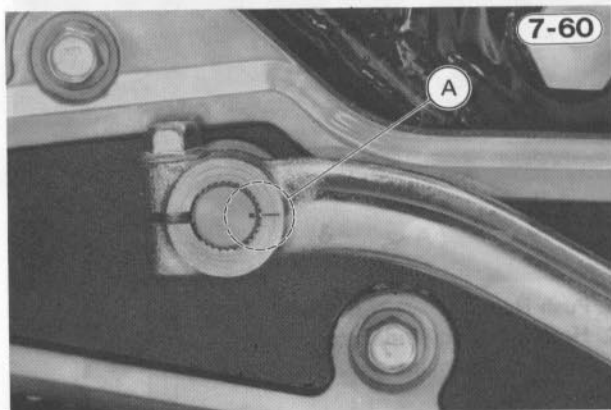

A. Align marks.

4. Bleed the brake line after master cylinder installation (Pg. 2-17).

5. Check the brake pedal position (Pg. 4-9) and the brake light switch (Pg. 2-18). Adjust them if necessary.
6. Check braking effectiveness.

#### Front Master Cylinder Installation

- NOTE:** 1. The master cylinder clamp must be installed with the small projection towards the throttle grip. Tighten the upper clamp bolt first, and then the lower clamp bolt both to 0.90 kg-m (78 in-lbs) of torque.

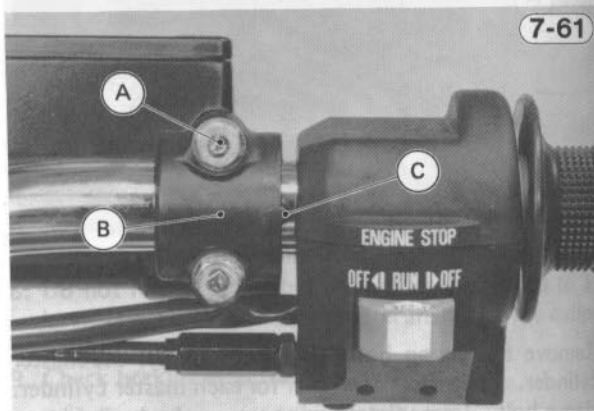

A. Tighten upper clamp bolt first. C. Projection  
B. Clamp

2. Use a new flat washer on each side of the brake hose fitting. Tighten the banjo bolt to 2.5 kg-m (18.0 ft-lbs) of torque.
3. Bleed the brake line after master cylinder installation (Pg. 2-17).
4. Check braking effectiveness.

#### Front Master Cylinder Disassembly and Assembly:

##### Front Master Cylinder Disassembly

- Remove the screws (2) (2), take off the master cylinder cap (3) and diaphragm (5), and empty out the brake fluid.
- Remove the locknut (7) and pivot bolt (4), and remove the brake lever (6).
- Using a thin-bladed screwdriver or some other suitable tool, press in the liner tabs which catch in the holes in the master cylinder, and then remove the liner (1).

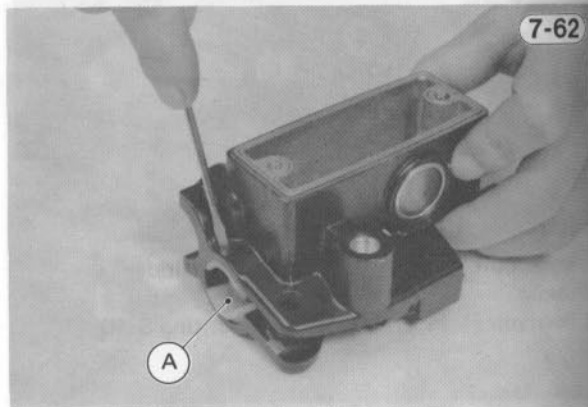

A. Liner

Front Master Cylinder

7-63

NOTE: Before assembly, clean all parts including the master cylinder with brake fluid or alcohol. (See WARNING - Pt. 2-16) and apply brake fluid to the removed parts and the inner wall of the cylinder. This is not to scratch the inner wall of the cylinder.

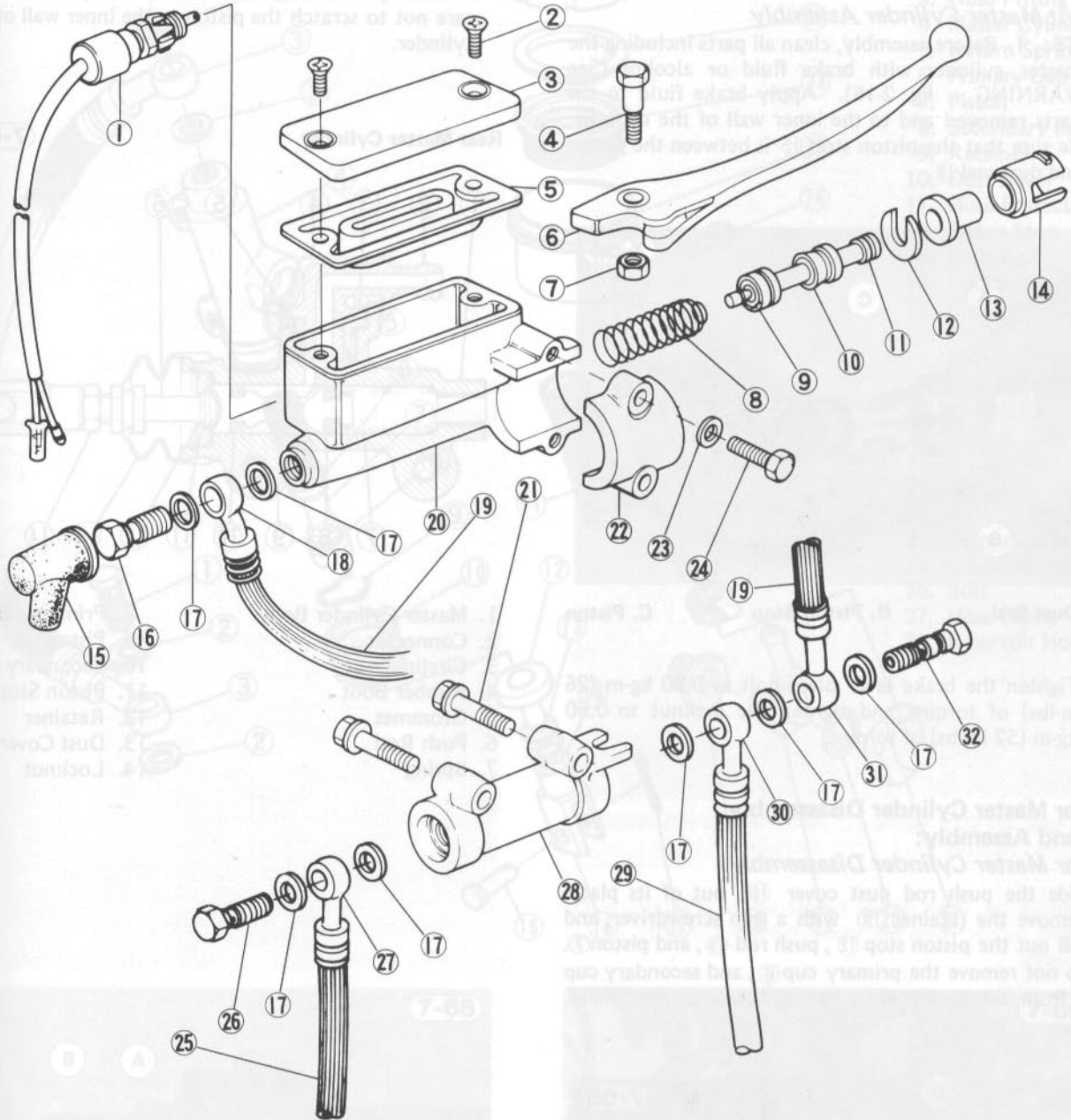

- |                             |                          |                           |                            |
|-----------------------------|--------------------------|---------------------------|----------------------------|
| 1. Front Brake Light Switch | 8. Spring                | 17. Flat Washer           | 26. Banjo (Fitting) Bolt   |
| 2. Screw                    | 9. Primary Cup           | 18. Hose Fitting          | 27. Hose Fitting           |
| 3. Master Cylinder Cap      | 10. Secondary Cup        | 19. Upper Brake Hose      | 28. 2-way Joint            |
| 4. Brake Lever Pivot Bolt   | 11. Piston               | 20. Master Cylinder Body  | 29. Lower Right Brake Hose |
| 5. Diaphragm                | 12. Piston Stop          | 21. Mounting Bolt         | 30. Hose Fitting           |
| 6. Barke Lever              | 13. Dust Seal            | 22. Master Cylinder Clamp | 31. Hose Fitting           |
| 7. Locknut                  | 14. Liner                | 23. Flat Washer           | 32. Banjo (Fitting) Bolt   |
|                             | 15. Dust Cover           | 24. Clamp Bolt            |                            |
|                             | 16. Banjo (Fitting) Bolt | 25. Lower Left Brake Hose |                            |

- Pull out the piston ① and spring ⑧.
- Remove the dust seal ⑬ and piston stop ⑫ from the piston.

**Front Master Cylinder Assembly**

- NOTE:** 1. Before assembly, clean all parts including the master cylinder with brake fluid or alcohol (See WARNING – Pg. 2-16). Apply brake fluid to the parts removed and to the inner wall of the cylinder.
2. Be sure that the piston stop ⑫ is between the piston and dust seal ⑬.

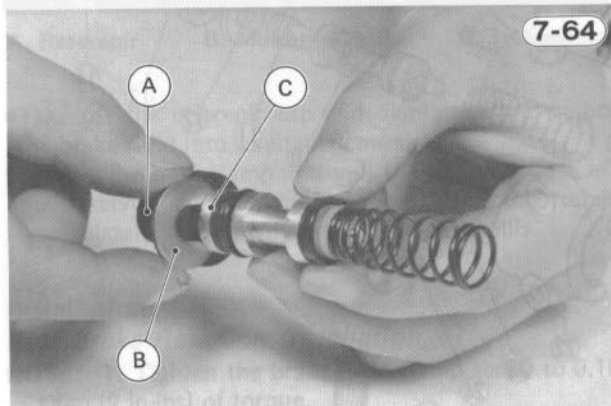

7-64

A. Dust Seal      B. Piston Stop      C. Piston

3. Tighten the brake lever pivot bolt to 0.30 kg-m (26 in-lbs) of torque, and tighten the locknut to 0.60 kg-m (52 in-lbs) of torque.

**Rear Master Cylinder Disassembly and Assembly:**

**Rear Master Cylinder Disassembly**

- Slide the push rod dust cover ⑩ out of its place.
- Remove the retainer ⑨ with a thin screwdriver, and pull out the piston stop ⑫, push rod ⑬, and piston ⑦. Do not remove the primary cup ⑥, and secondary cup ⑧ from the piston since removal will damage them.

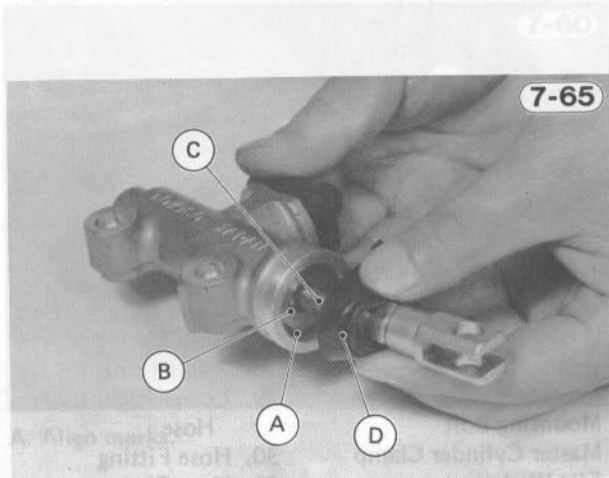

7-65

A. Retainer      C. Push Rod  
B. Piston Stop      D. Dust Cover

**Rear Master Cylinder Assembly**

- NOTE:** 1. Before assembly, clean all parts including the master cylinder with brake fluid or alcohol (See WARNING – Pg. 2-16), and apply brake fluid to the removed parts and the inner wall of the cylinder. Take care not to scratch the piston or the inner wall of the cylinder.

**Rear Master Cylinder**

7-66

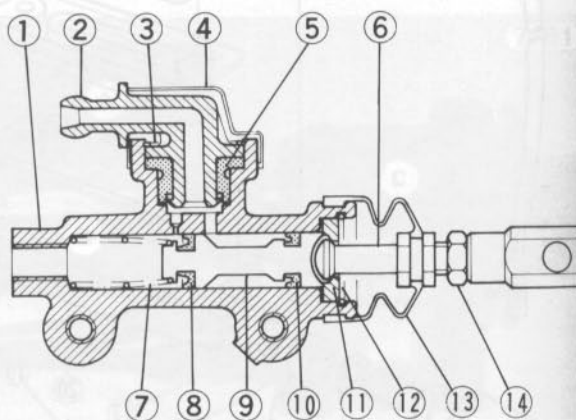

- |                         |                   |
|-------------------------|-------------------|
| 1. Master Cylinder Body | 8. Primary Cup    |
| 2. Connector            | 9. Piston         |
| 3. Circlip              | 10. Secondary Cup |
| 4. Rubber Boot          | 11. Piston Stop   |
| 5. Grommet              | 12. Retainer      |
| 6. Push Rod             | 13. Dust Cover    |
| 7. Spring               | 14. Locknut       |

**CLUTCH CABLE**

**Removal:**

**Clutch Cable Removal**

- Remove the engine sprocket cover (Pg. 6-28).
- Loosen the knurled locknut on the clutch lever, and screw in the adjuster.
- Line up the slots in the clutch lever, knurled locknut, and adjuster and free the cable from the lever.

Rear Master Cylinder, Reservoir

7-67

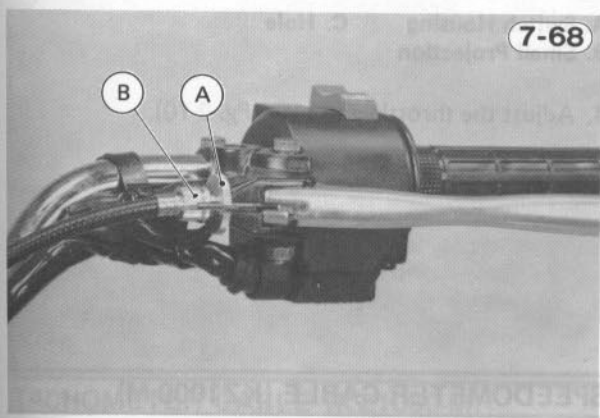
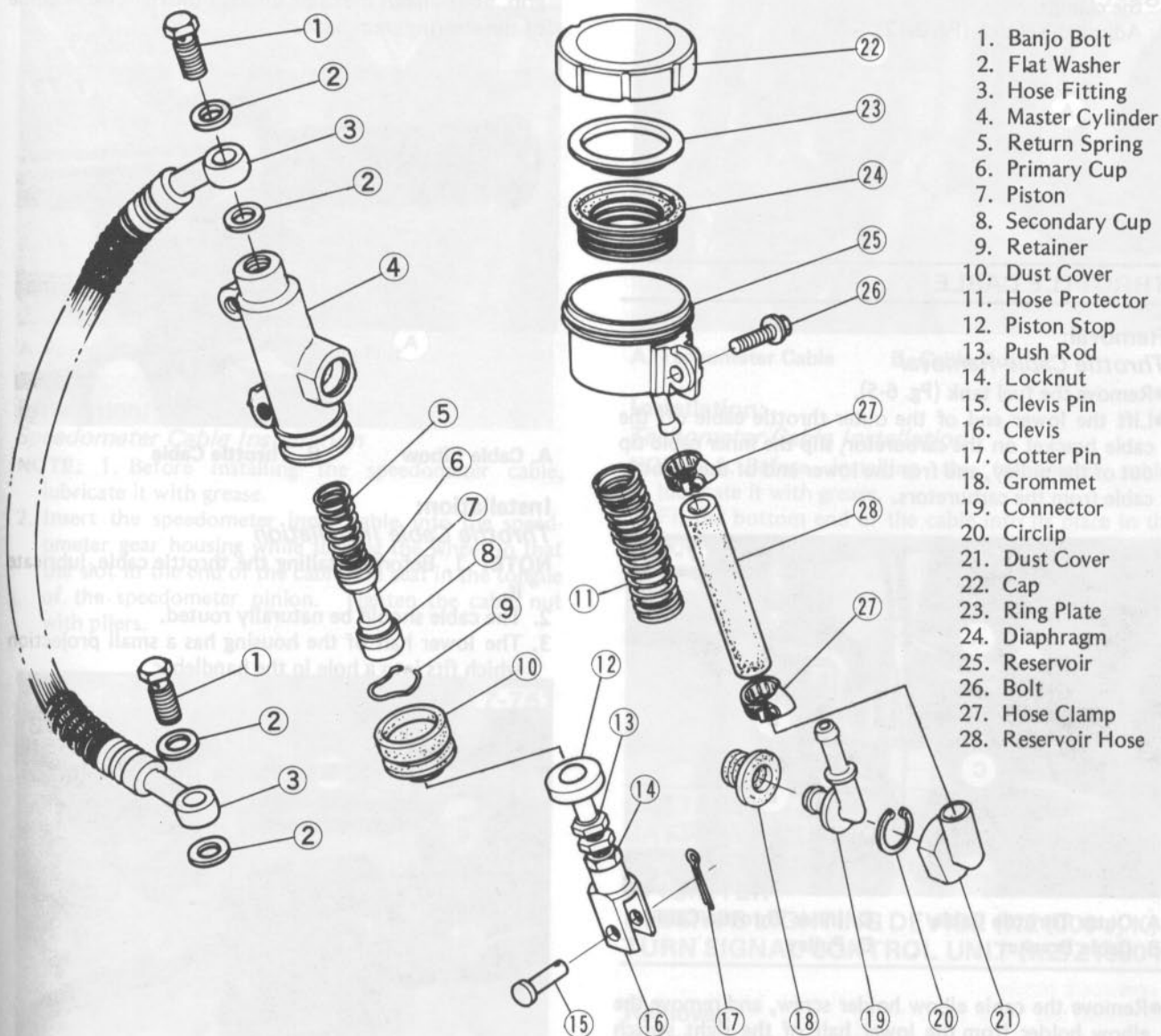

7-68

A. Locknut B. Adjuster

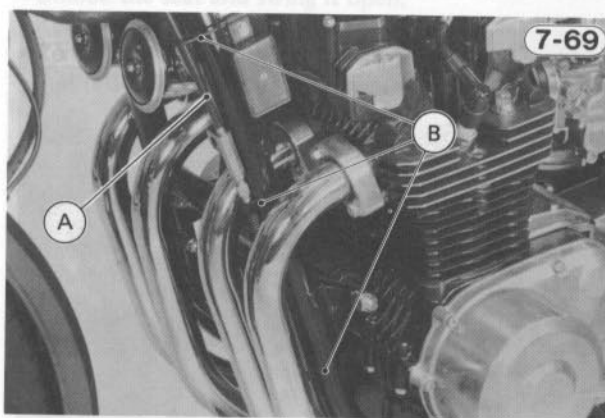

7-69

A. Clutch Cable B. Clamps

Remove the cable camps (2), and pull the cable free from the motorcycle. There is a cable guide at the left side of the steering stem head of the KZ/Z1000-J.

Installation:

Clutch Cable Installation

NOTE: 1. Before installing the clutch cable, lubricate it.

2. Fasten the clutch cable to the frame down tube with the clamps.
3. Adjust the clutch (Pg. 2-12).

## THROTTLE CABLE

### Removal:

#### Throttle Cable Removal

- Remove the fuel tank (Pg. 6-5).
- Lift the lower end of the outer throttle cable off the cable bracket on the carburetor, slip the inner cable tip out of the pulley, and free the lower end of the throttle cable from the carburetors.

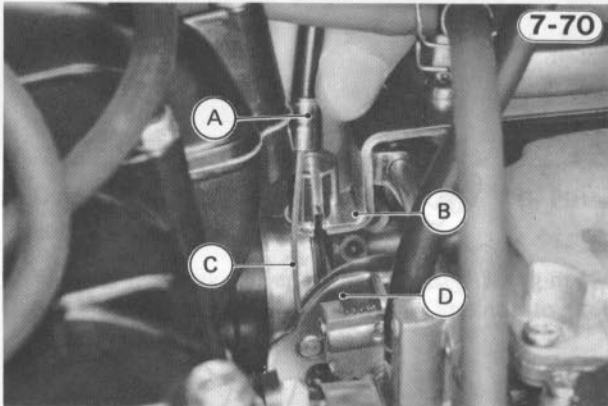

A. Outer Throttle Cable  
B. Cable Bracket  
C. Inner Throttle Cable  
D. Pulley

- Remove the cable elbow holder screw, and remove the elbow holder from the lower half of the right switch housing.

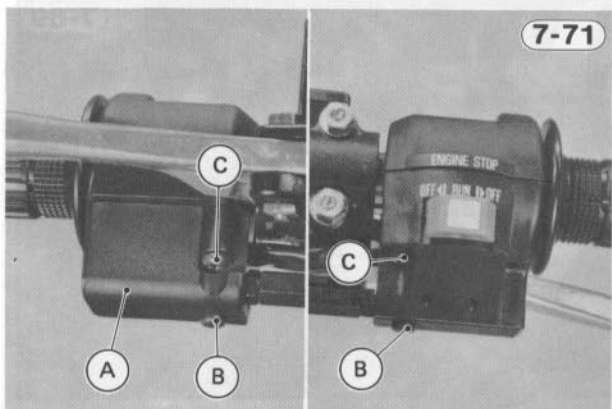

A. Elbow Holder  
B. Holder Screw  
C. Switch Housing Screws

- Remove the right switch housing screws (2), and open the housing.

- Slip the throttle cable tip from its catch in the throttle grip, and pull out the cable through the right cable guide of the steering stem head.

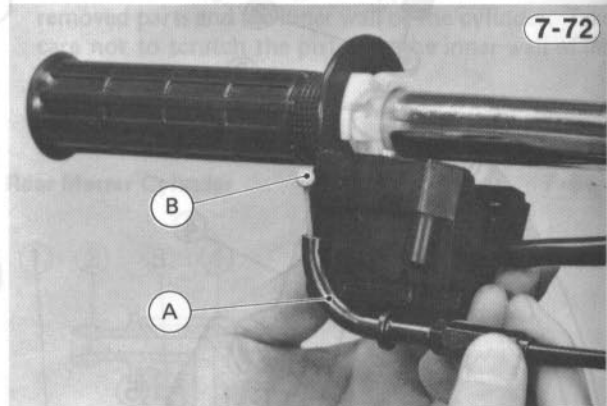

A. Cable Elbow  
B. Throttle Cable

### Installation:

#### Throttle Cable Installation

- NOTE:** 1. Before installing the throttle cable, lubricate it.  
2. The cable should be naturally routed.  
3. The lower half of the housing has a small projection which fits into a hole in the handlebar.

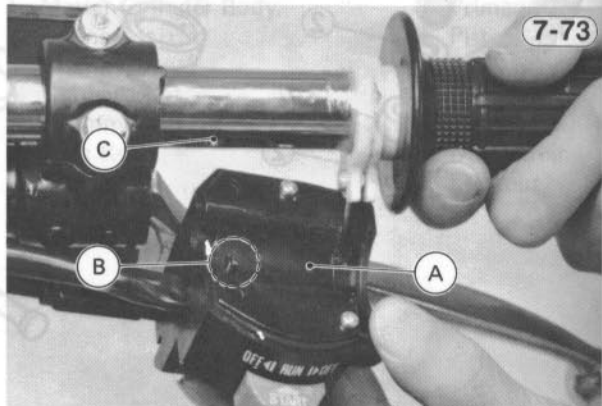

A. Switch Housing  
B. Small Projection  
C. Hole

4. Adjust the throttle grip play (Pg. 2-10).

## SPEEDOMETER CABLE (KZ1000-M)

### Removal:

#### Speedometer Cable Removal

- Disconnect the cable nut at the upper and lower ends of the speedometer cable with pliers.
- Pull the cable free.

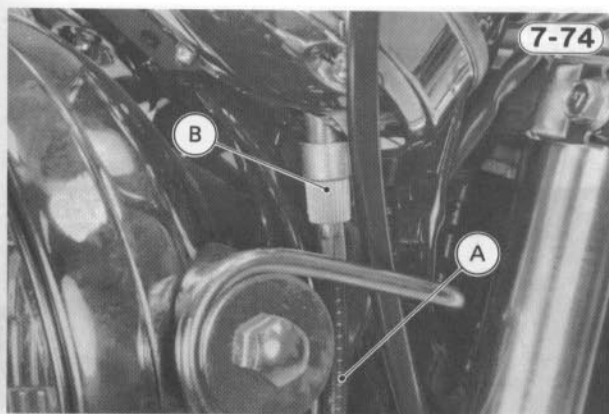

A. Speedometer Cable B. Cable Nut

#### Installation:

##### Speedometer Cable Installation

- NOTE:** 1. Before installing the speedometer cable, lubricate it with grease.
2. Insert the speedometer inner cable into the speedometer gear housing while turning the wheel so that the slot in the end of the cable will seat in the tongue of the speedometer pinion. Tighten the cable nut with pliers.

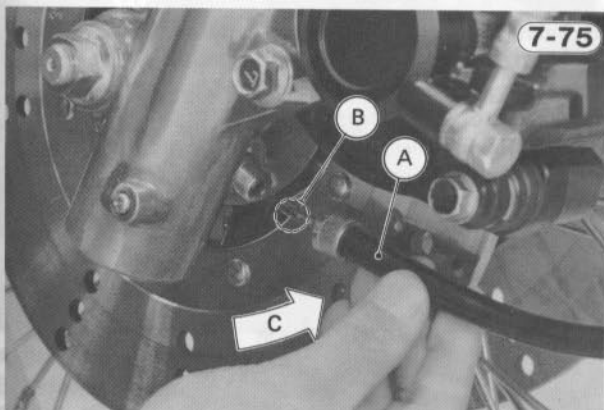

A. Speedometer Cable B. Slot C. Turn.

#### TACHOMETER CABLE (KZ1000-M)

#### Removal:

##### Tachometer Removal

- Disconnect the cable nut at the upper and lower ends of the tachometer cable with pliers.
- Free the cable from the motorcycle.

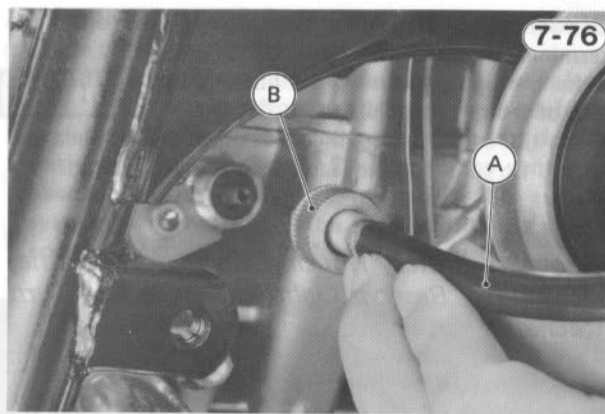

A. Tachometer Cable B. Cable Nut

#### Installation:

##### Tachometer Cable Installation

- NOTE:** 1. Before installing the tachometer cable, lubricate it with grease.
2. Fit the bottom end of the cable into its place in the cylinder head. Turn it if necessary so that it fits all the way into place, and tighten its nut with pliers. There is a gasket between the outer cable and the tachometer pinion holder.

#### BATTERY BATTERY HOUSING REGULATOR/RECTIFIER IC IGNITER RESERVE LIGHTING DEVICE (KZ1000-J, K) TURN SIGNAL CONTROL UNIT (KZ/Z1000-K)

#### Removal:

##### Battery Removal

- Unlock the seat and swing it open.
- Remove the right side cover.
- Remove the bolt, and take off the battery holder so that it does not hinder battery removal.

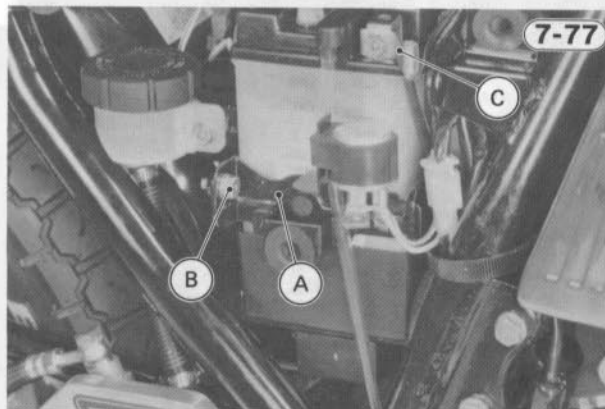

A. Battery Holder B. Bolt C. Remove — lead first.



- Disconnect the leads from the battery, first from the - terminal and then the + terminal.
- Take the battery out of the housing toward the right side of the motorcycle.
- Clean the battery using the solution of baking soda and water. Be sure that the lead connections are clean.

### Removal of Battery Housing, Regulator/Rectifier, IC Igniter, Reserve Lighting Device, and Turn Signal Control Unit

- Remove the bolt, and free the brake fluid reservoir from the battery housing.
- Disconnect the 4-pin pickup coil connector, loosen the strap, and free the IC igniter wiring harness from the frame.

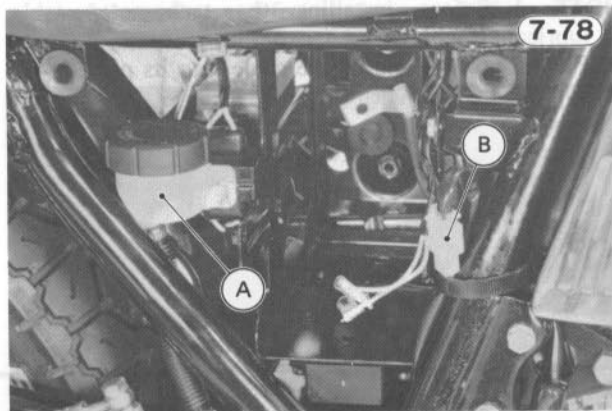

A. Reservoir B. 4-Pin Pickup Connector

- Remove the left side cover, and disconnect all male 6-pin connectors from the female connectors on the connector holder.
- Remove the bolts (3), remove the connector holding plate, and pull the female 6-pin connectors free from the connector holder.

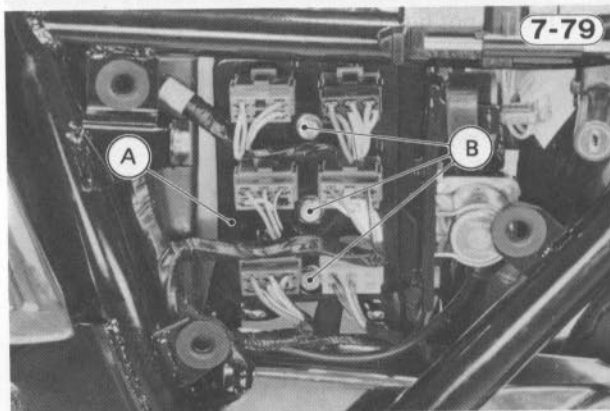

A. Connector Holding Plate B. Bolts

- Take off the tool kit and its tray.

- Remove the bolts (2), and slide the front half of the rear fender rearwards off the frame.
- Disconnect the red/white, white/blue, white/red, and white leads of the fuse boxes.

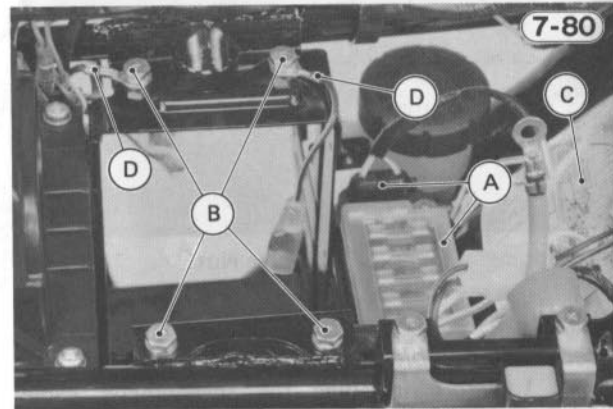

A. Fuse Boxes  
B. Housing Mounting Bolts  
C. Remove front half of rear fender.  
D. Black/Yellow Ground leads are also secured with housing mounting bolts.

- Remove the battery housing mounting bolts (4), turn the battery housing 90° (the right side of the housing faces the front), and remove the housing by sliding it out the top of the frame.
- The following electrical parts shown in Fig. 7-81 are mounted at the bottom of the battery housing.

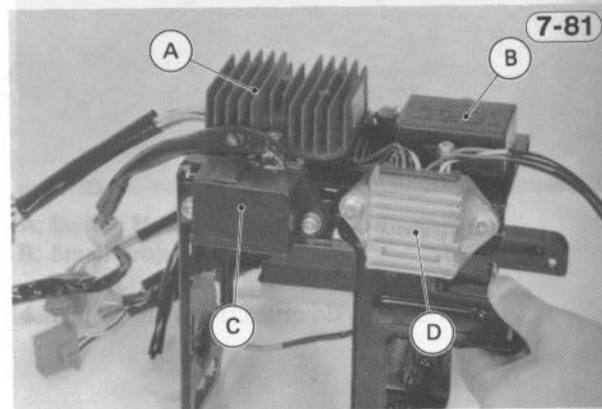

A. Regulator/Rectifier  
B. Turn Signal Control Unit  
C. Reserve Lighting Device  
D. IC Igniter

### Installation:

#### Installation of Battery Housing, Regulator/Rectifier, IC Igniter, Reserve Lighting Device, and Turn Signal Control Unit

NOTE: 1. Hook three wiring harness in the harness clamps on the battery housing.

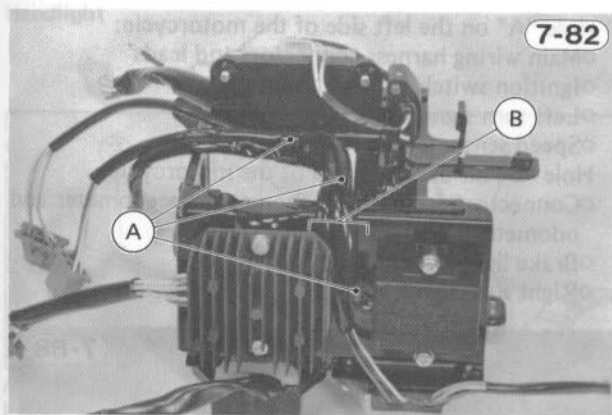

7-82

- A. Clamps  
B. Harnesses, one from IC igniter and two from turn signal control unit.

2. Install the female 6-pin connectors in the positions indicated in Fig. 7-83. Connect the black male connector of the main wiring harness with the upper righthand connector for the fuse box.

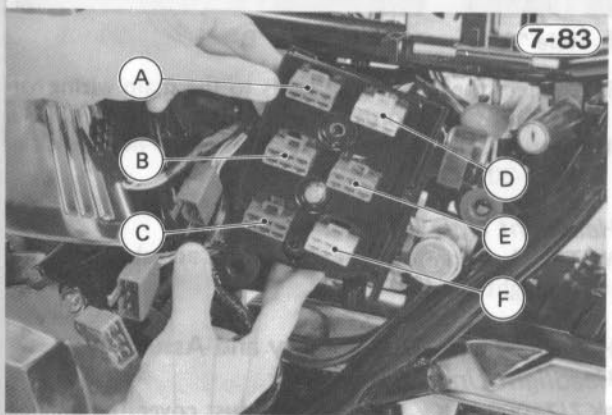

7-83

- A. Blue Connector  
B. Green Connector  
C. Brown Connector  
D. Black or White Connector from Fuse Box  
E. Red Connector  
F. White Connector from IC Igniter

3. Install the two black/yellow leads on the frame using the housing mounting bolts (Fig. 7-80).  
4. Check braking effectiveness, bleed the air from the brake line if necessary.

#### Battery Installation

- Check that the rubber dampers are properly installed in the battery housing.
- Put the battery in the battery tray, slip the battery with its tray into the housing, and route the battery vent hose as shown on the caution label.
- Connect the capped lead to the + terminal, and then connect the black lead to the - terminal.
- Cover the + terminal with its protective cap.
- Install the battery holder, and tighten its bolt. Be careful not to pinch the battery vent hose between the

holder and the battery; the vent hose must be routed outside of the battery holder.

#### CAUTION

1. Make sure the battery vent hose is kept away from the drive chain and exhaust system. Battery electrolyte can corrode and dangerously weaken the chain. Do not let the vent hose become folded, pinched, or melted by the exhaust system. An unvented battery will not keep a charge and it may crack from built-up gas pressure.

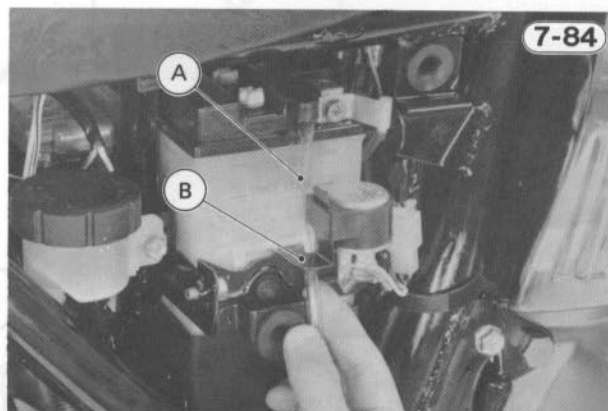

7-84

- A. Do not pinch vent hose between battery and holder.  
B. Battery Holder

- Install the right side cover, and close the seat.

#### HEADLIGHT UNIT HEADLIGHT HOUSING HEADLIGHT BRACKET

#### Removal:

##### Headlight Unit Removal

- Take out the mounting screws (2), and pull the headlight unit out of its housing.

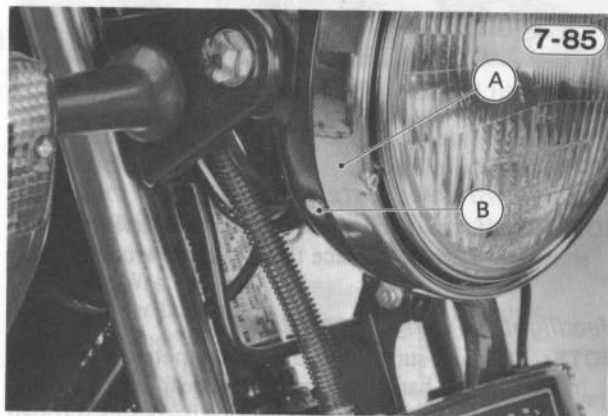

7-85

- A. Headlight Unit      B. Mounting Screws

- Disconnect the headlight socket from the rear of the unit, pull out the city light also for the European models, and free the unit from the motorcycle.

**Headlight Housing Removal**

- Disconnect all leads and connectors in the headlight housing, and take them all out of the housing.
- Remove the headlight housing mounting bolts (3), and remove the housing.

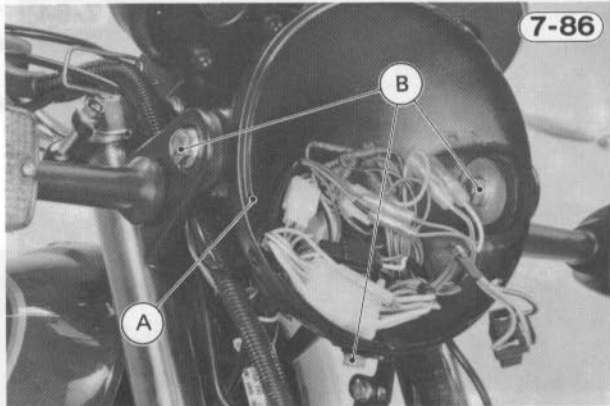

A. Housing B. Mounting Bolts

**Headlight Bracket Removal**

- KZ1000-M: Disconnect the upper end of the tachometer and speedometer cables from the meter.
- Remove the screws (2), and take off the stem base cover.
- Remove the bolts (3), and remove the headlight bracket assembly.

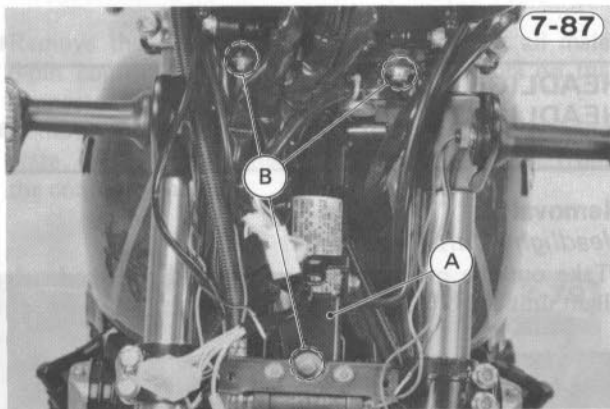

A. Headlight Bracket B. Mounting Bolts

**Installation:**

**Headlight Bracket Installation**

**NOTE:** 1. If the rubber dampers are deteriorated or show any damage, replace them with new ones.

**Headlight Housing Installation**

**NOTE:** 1. Make sure the rubber grommets are installed in the wiring harness holes in the headlight housing.  
2. Route the following leads and wiring harnesses through the holes indicated in Fig. 7-88.

- Hole "A" on the left side of the motorcycle:
  - Main wiring harness connectors and leads
  - Ignition switch wiring harness
  - Left turn signal leads
  - Speed sensor wiring harness
- Hole "B" on the right side of the motorcycle:
  - Connectors from the tachometer, speedometer and odometer
  - Brake light switch leads
  - Right turn signal leads

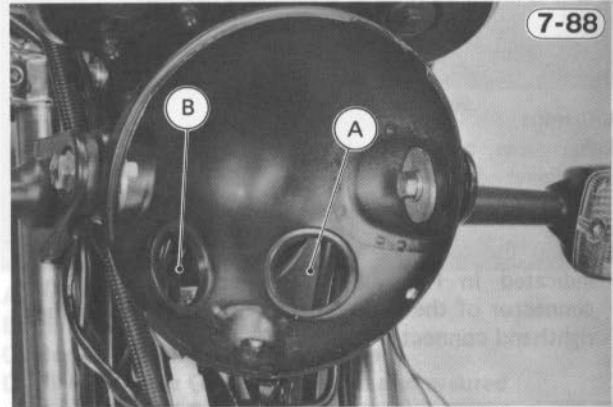

A. Hole "A" B. Hole "B"

3. Connect the turn signal leads to the main wiring harness leads in accordance with Table 7-1 on Pg. 7-30.
4. Carry out the vertical adjustment of the headlight aim (Pg. 5-20).

**Headlight Unit Installation**

**NOTE:** 1. Carry out the horizontal adjustment of the headlight aim (Pg. 5-20).

**Headlight Unit Disassembly and Assembly:**

**Headlight Unit Disassembly**

- KZ/Z1000-J, K: Remove the dust cover (11), unhook the headlight bulb retaining spring, and take out the bulb.

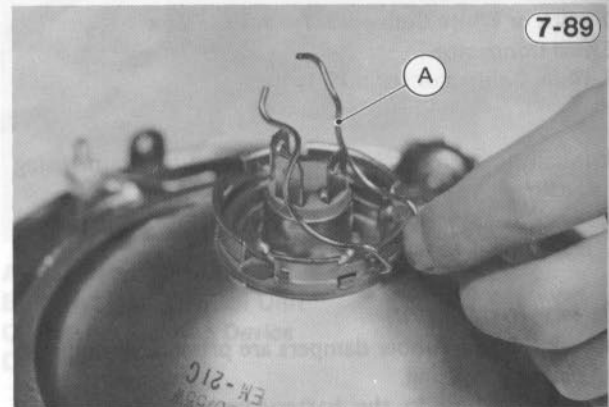

A. Retaining Spring

**CAUTION**

1. When handling the quartz-halogen bulb, never touch the glass portion with bare hands. Always use a clean cloth. Oil contamination from hands or dirty rags can reduce bulb life or even cause the bulb to explode.

Headlight

7-90

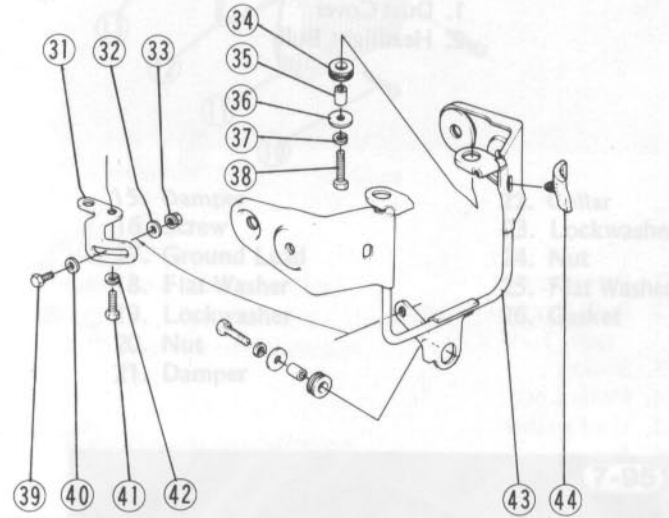
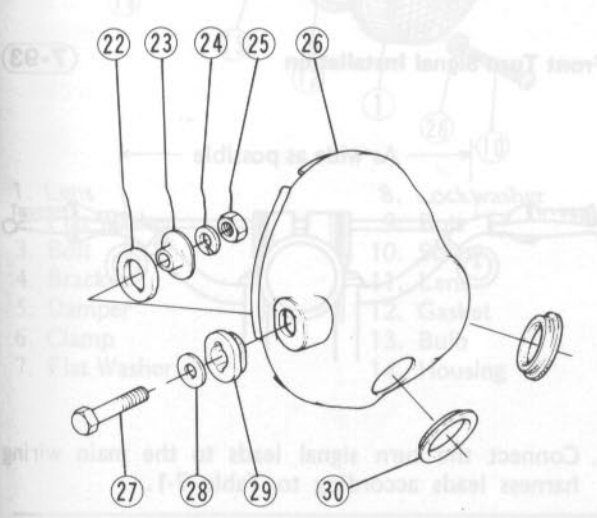
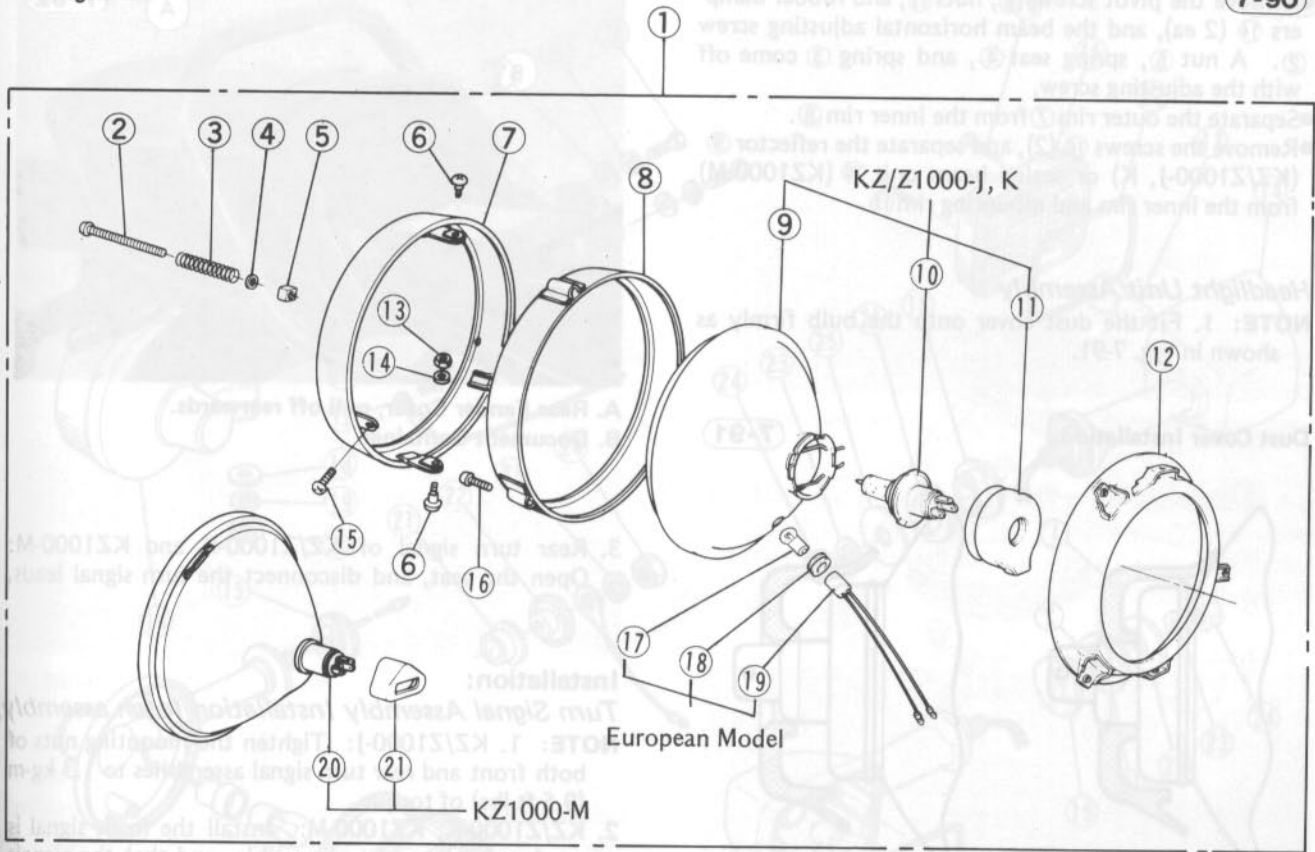

- |                         |                      |                       |                       |
|-------------------------|----------------------|-----------------------|-----------------------|
| 1. Headlight Unit       | 12. Mounting Rim     | 23. Collar            | 34. Rubber Damper     |
| 2. Adjusting Screw      | 13. Nut              | 24. Lockwasher        | 35. Collar            |
| 3. Spring               | 14. Rubber Damper    | 25. Nut               | 36. Flat Washer       |
| 4. Spring Seat          | 15. Screw            | 26. Headlight Housing | 37. Lockwasher        |
| 5. Square Nut           | 16. Screw            | 27. Bolt              | 38. Bolt              |
| 6. Pivot Screw          | 17. City Light       | 28. Flat Washer       | 39. Bolt              |
| 7. Outer Rim            | 18. Rubber Damper    | 29. Rubber Damper     | 40. Flat Washer       |
| 8. Inner Rim            | 19. Bulb Socket      | 30. Grommet           | 41. Bolt              |
| 9. Reflector            | 20. Sealed Beam Unit | 31. Housing Stay      | 42. Lockwasher        |
| 10. Quartz-Halogen Bulb | 21. Dust Cover       | 32. Flat Washer       | 43. Headlight Bracket |
| 11. Dust Cover          | 22. Rubber Damper    | 33. Nut               | 44. Rubber Damper     |

- Remove the pivot screws (6), nuts (13), and rubber dampers (14) (2 ea), and the beam horizontal adjusting screw (2). A nut (5), spring seat (4), and spring (3) come off with the adjusting screw.
- Separate the outer rim (7) from the inner rim (8).
- Remove the screws (16) (2), and separate the reflector (9) (KZ/Z1000-J, K) or sealed beam unit (20) (KZ1000-M) from the inner rim and mounting rim (12).

**Headlight Unit Assembly**

**NOTE:** 1. Fit the dust cover onto the bulb firmly as shown in Fig. 7-91.

**Dust Cover Installation**

7-91

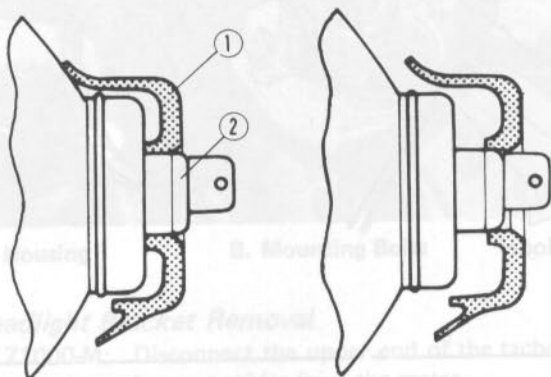

Good

Bad

1. Dust Cover
2. Headlight Bulb

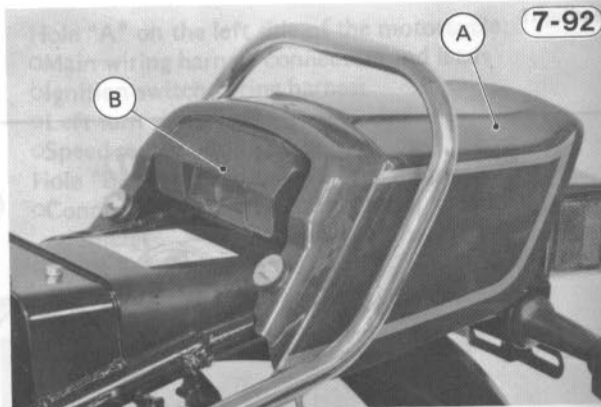

7-92

- A. Rear Fender Cover, pull off rearwards.
- B. Document Container

3. Rear turn signal of KZ/Z1000-K and KZ1000-M: Open the seat, and disconnect the turn signal leads.

**Installation:**

**Turn Signal Assembly Installation (each assembly)**

- NOTE:** 1. KZ/Z1000-J: Tighten the mounting nuts of both front and rear turn signal assemblies to 1.3 kg-m (9.5 ft-lbs) of torque.
2. KZ/Z1000-K, KZ1000-M: Install the front signal as close to the grip as possible, and that the signals point straight ahead.

**Front Turn Signal Installation**

7-93

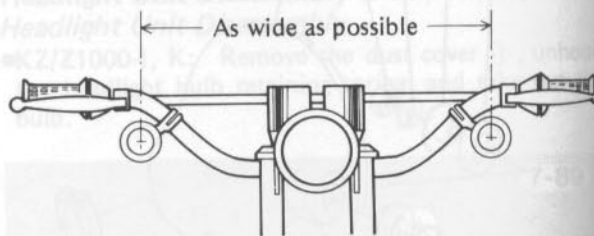

3. Connect the turn signal leads to the main wiring harness leads according to Table 7-1.

**TURN SIGNAL ASSEMBLIES**

**Removal:**

**Turn Signal Assembly Removal (each assembly)**

- NOTE:** 1. Front turn signal: Remove the headlight unit, and disconnect the turn signal leads in the headlight housing.
2. Rear turn signal of KZ/Z1000-J: Remove the rear fender cover and document container, and disconnect the turn signal leads. The rear fender cover is mounted on the frame with two bolts, and the document container with one bolt.

**Table 7-1 Turn Signal Lead Connections**

Turn Signal Lead	↔ Main Wiring Harness lead
Green or gray lead of left turn signal	↔ Green lead
Green or gray lead of right turn signal	↔ Gray lead
Black leads of front turn signals of US and Canadian model KZ1000-K and M	↔ Black/yellow lead

Turn Signals

7-94

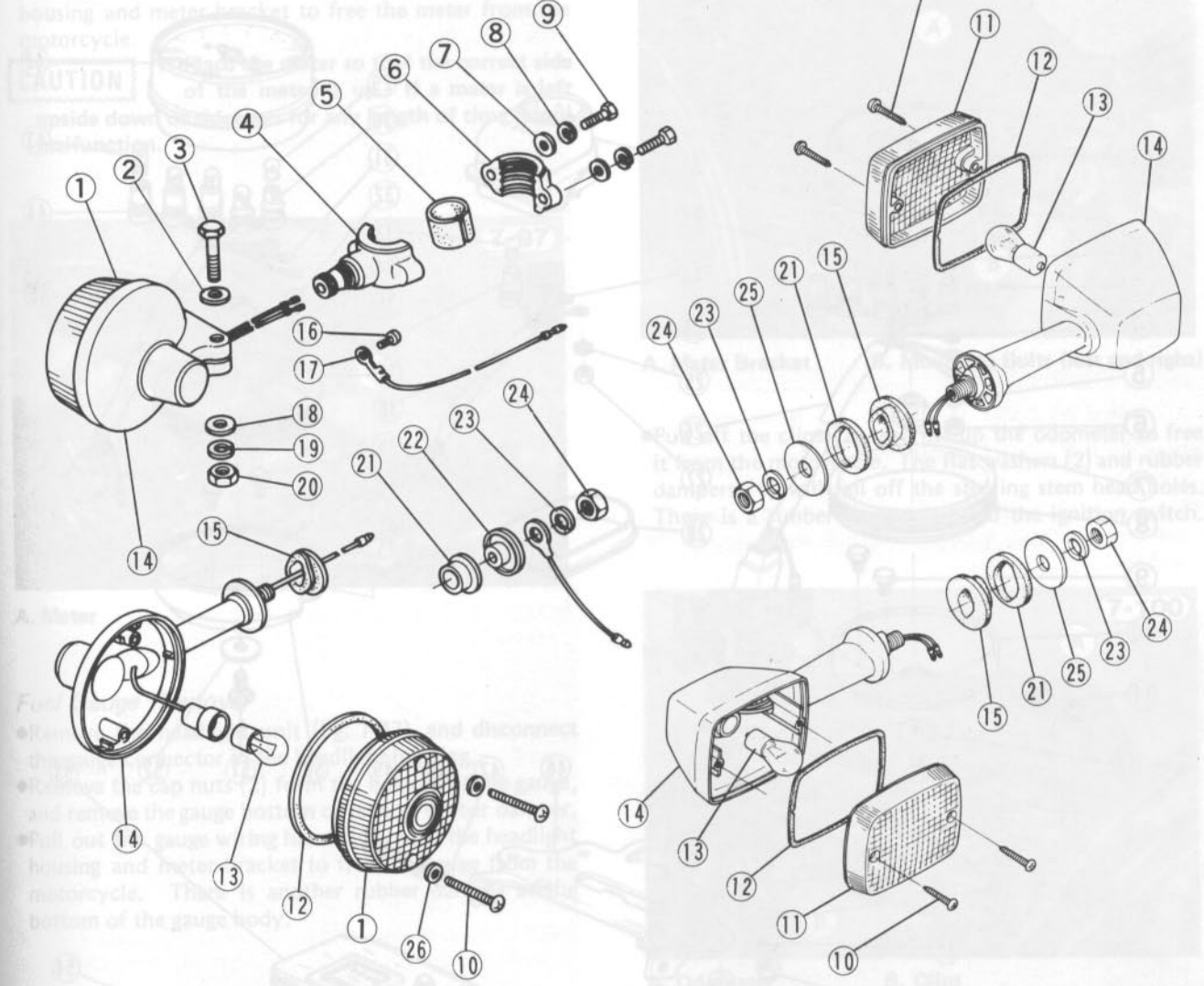

- 1. Lens
- 2. Flat Washer
- 3. Bolt
- 4. Bracket
- 5. Damper
- 6. Clamp
- 7. Flat Washer

- 8. Lockwasher
- 9. Bolt
- 10. Screw
- 11. Lens
- 12. Gasket
- 13. Bulb
- 14. Housing

- 15. Damper
- 16. Screw
- 17. Ground Lead
- 18. Flat Washer
- 19. Lockwasher
- 20. Nut
- 21. Damper

- 22. Collar
- 23. Lockwasher
- 24. Nut
- 25. Flat Washer
- 26. Gasket

**SPEEDOMETER  
TACHOMETER  
FUEL GAUGE  
ODOMETER**  
(all on KZ/Z1000-J, K)

**Removal:**

*Speedometer and Tachometer Removal*

- Remove the headlight unit (Pg. 7-27), and disconnect the meter connector and lead in the headlight housing.
- Remove the cap nuts, lockwashers, and flat washers (2 ea) from the bottom of the meter.

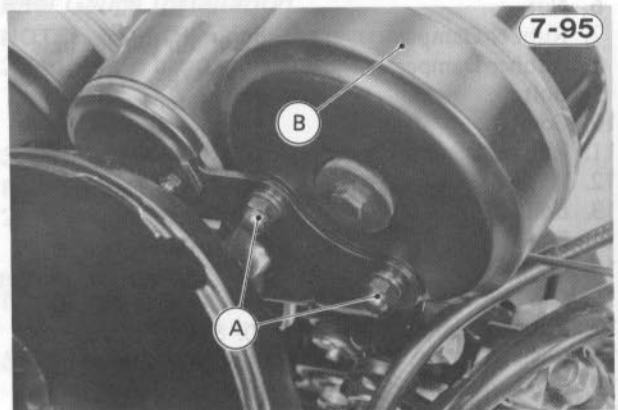

A. Cap Nuts

B. Meter

7-95

Meters and Gauge (KZ/Z1000-J, K)

7-96

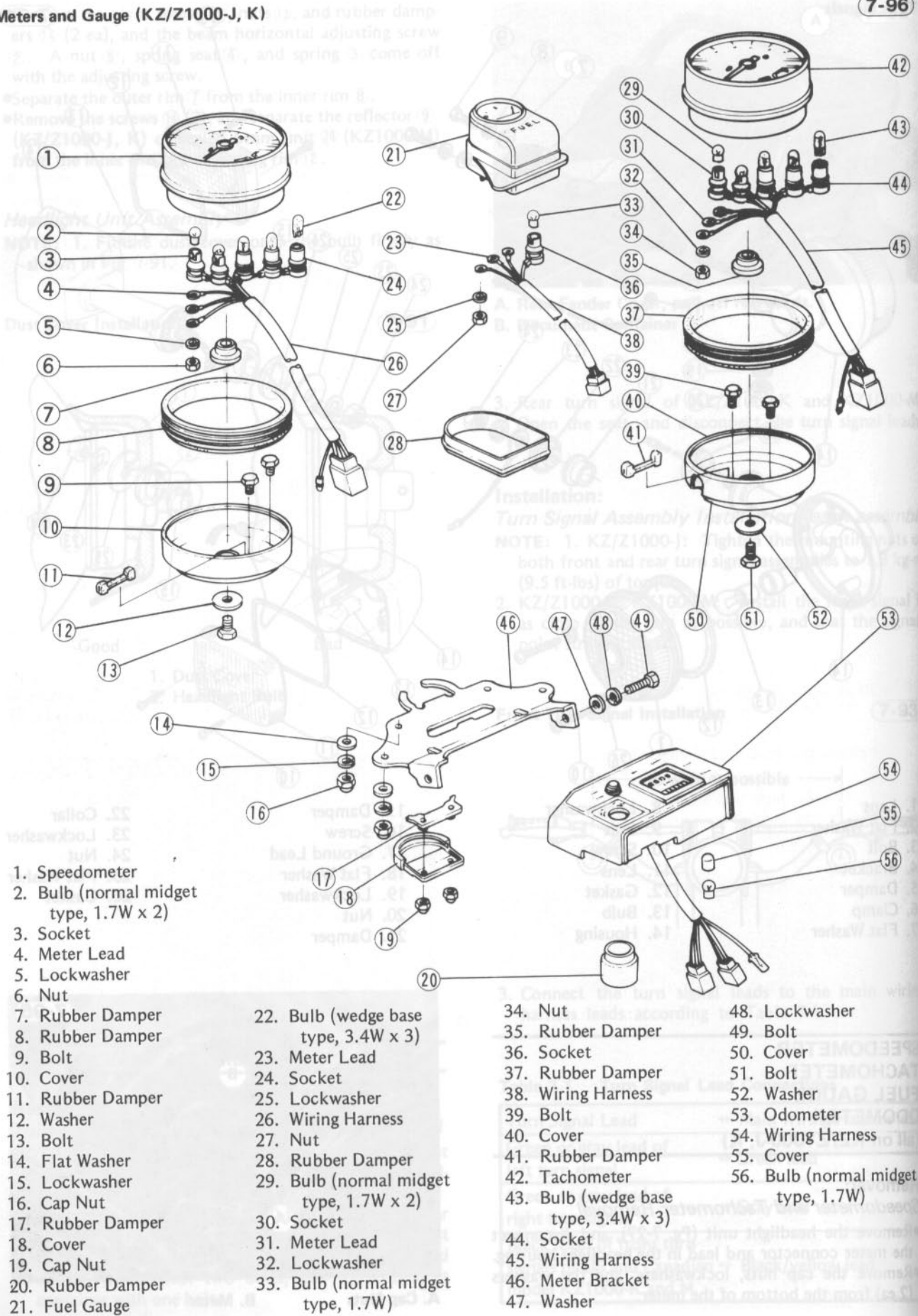

- 1. Speedometer
- 2. Bulb (normal midget type, 1.7W x 2)
- 3. Socket
- 4. Meter Lead
- 5. Lockwasher
- 6. Nut
- 7. Rubber Damper
- 8. Rubber Damper
- 9. Bolt
- 10. Cover
- 11. Rubber Damper
- 12. Washer
- 13. Bolt
- 14. Flat Washer
- 15. Lockwasher
- 16. Cap Nut
- 17. Rubber Damper
- 18. Cover
- 19. Cap Nut
- 20. Rubber Damper
- 21. Fuel Gauge

- 22. Bulb (wedge base type, 3.4W x 3)
- 23. Meter Lead
- 24. Socket
- 25. Lockwasher
- 26. Wiring Harness
- 27. Nut
- 28. Rubber Damper
- 29. Bulb (normal midget type, 1.7W x 2)
- 30. Socket
- 31. Meter Lead
- 32. Lockwasher
- 33. Bulb (normal midget type, 1.7W)

- 34. Nut
- 35. Rubber Damper
- 36. Socket
- 37. Rubber Damper
- 38. Wiring Harness
- 39. Bolt
- 40. Cover
- 41. Rubber Damper
- 42. Tachometer
- 43. Bulb (wedge base type, 3.4W x 3)
- 44. Socket
- 45. Wiring Harness
- 46. Meter Bracket
- 47. Washer

- 48. Lockwasher
- 49. Bolt
- 50. Cover
- 51. Bolt
- 52. Washer
- 53. Odometer
- 54. Wiring Harness
- 55. Cover
- 56. Bulb (normal midget type, 1.7W)

Installation:  
Turn Signal Assembly

NOTE: 1. KZ/Z1000-J  
both front and rear turn signals  
(9.5 ft-lbs) of torque  
KZ/Z1000-K

- Pull out the meter wiring harness through the headlight housing and meter bracket to free the meter from the motorcycle.

**CAUTION**

1. Place the meter so that the correct side of the meter is up. If a meter is left upside down or sideways for any length of time it will malfunction.

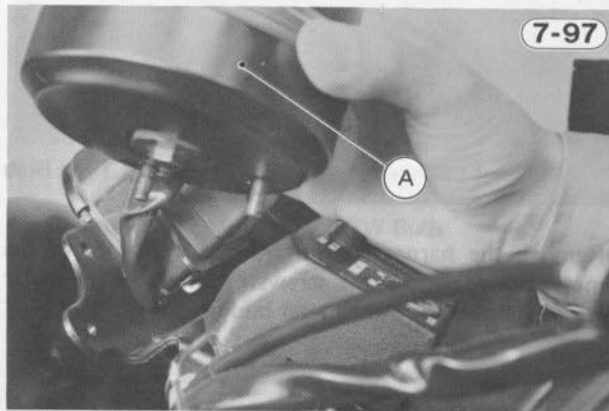

A. Meter

**Fuel Gauge Removal**

- Remove the headlight unit (Pg. 7-27), and disconnect the gauge connector in the headlight housing.
- Remove the cap nuts (2) from the bottom of the gauge, and remove the gauge bottom cover and rubber damper.
- Pull out the gauge wiring harness through the headlight housing and meter bracket to free the gauge from the motorcycle. There is another rubber damper at the bottom of the gauge body.

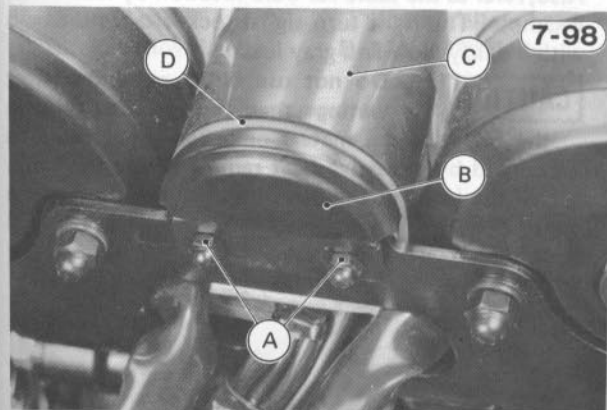

A. Cap Nuts B. Cover C. Fuel Gauge D. Damper

**Odometer Removal**

- Remove the headlight unit (Pg. 7-27), and disconnect the connectors and leads from the speedometer, tachometer, and fuel gauge.
- Remove the meter bracket mounting bolts (2), and remove the meter and gauge assembly from the steering stem head.

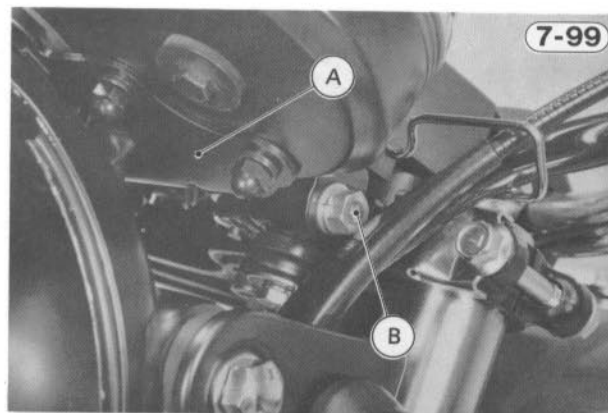

A. Meter Bracket B. Mounting Bolts (left and right)

- Pull off the clips (2), and lift up the odometer to free it from the motorcycle. The flat washers (2) and rubber dampers (4) will fall off the steering stem head holes. There is a rubber damper around the ignition switch.

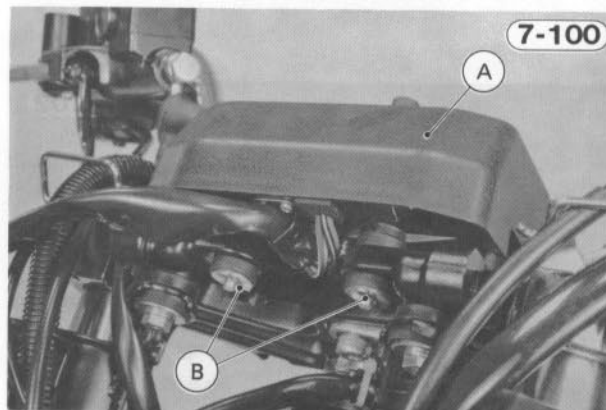

A. Odometer B. Clips

**Installation:****Odometer Installation**

- NOTE:** 1. Installation is the reverse of removal.  
2. Adjust the headlight aim.

**Fuel Gauge Installation**

- NOTE:** 1. Installation is the reverse of removal.  
2. Adjust the headlight aim

**Speedometer and Tachometer Installation**

- NOTE:** 1. Installation is the reverse of removal.  
2. Adjust the headlight aim

**Meter and Gauge Disassembly  
(including bulb replacement)****Speedometer and Tachometer Disassembly  
(each meter)**

- Holding the meter body stationary by hand, remove the bolt and washer from the bottom of the meter.



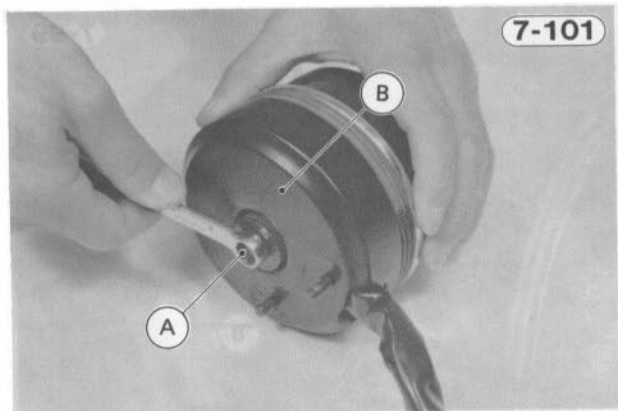

A. Bolt B. Cover

- Remove the meter bottom cover, rubber damper, and bolts (2).
- To remove the indicator light bulbs (wedge base type), pull out the bulb sockets, and pull the bulb off the socket.

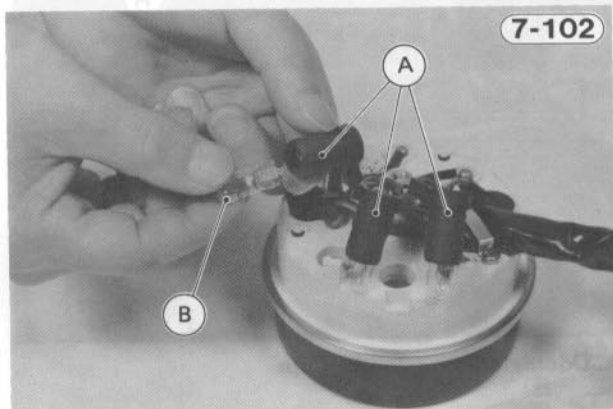

A. Indicator Light Sockets B. Wedge-Base Type Bulb

- To remove the meter light bulb (normal midget type), sockets off the bottom of the meter body. First press the bulb inwards, then holding the bulb in this position, twist it to the left and pull it out.

Table 7-2 Indicator and Meter Lights

Bulb Wattage and Type	Lights	Lead Color
12V 1.7W (Normal midget type)	Meter and gauge illuminator x 6	Red/blue, black/yellow
12V 3.4W (Wedge base type)	Left turn signal indicator	Green, black/yellow
	Oil pressure warning	Brown, blue/red
	Neutral indicator	Brown, light green
	High beam indicator	Red/black, black/yellow
	Headlight failure indicator	Green/red, black/yellow
	Right turn signal indicator	Gray, black/yellow

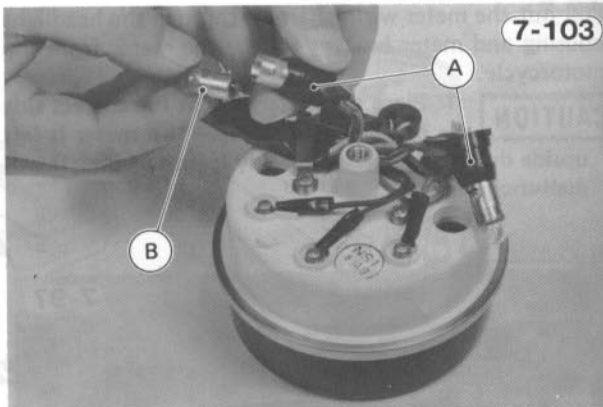

A. Meter Light Sockets B. Normal Midget Type Bulb

- Remove the harness clamp from the bottom of the meter body, remove the screws (3), and free the meter wiring harness from the meter body.

#### Fuel Gauge Disassembly

**NOTE:** 1. The illuminator bulb is of normal midget type.

#### Odometer Disassembly

**NOTE:** 1. The illuminator bulb is of normal midget type.

#### Meter and Gauge Assembly

##### Meter and Gauge Assembly

**NOTE:** 1. Use the bulbs shown in Table 7-2 for indicator and meter illuminator light replacement. Also, refer to the table for bulb location by lead color. Example: The right turn signal socket takes the bulb with black/yellow and gray leads.

#### CAUTION

1. Do not use bulbs rated for larger wattage than the specified value in the table, as the meters or gauge panel could be warped by excessive heat radiated from the bulbs.
2. Install the leads in the position at the bottom of the meter as shown in Fig. 7-104 through 7-107, and hold the wiring harness with the clamp.

**Odometer:**

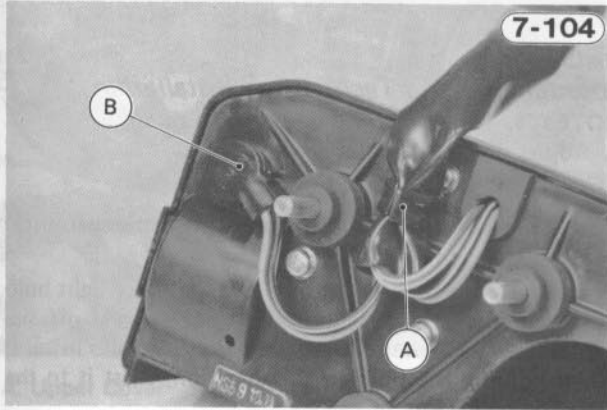

**A. Clamp**      **B. 12V 1.7W Bulb**

**Fuel Gauge:**

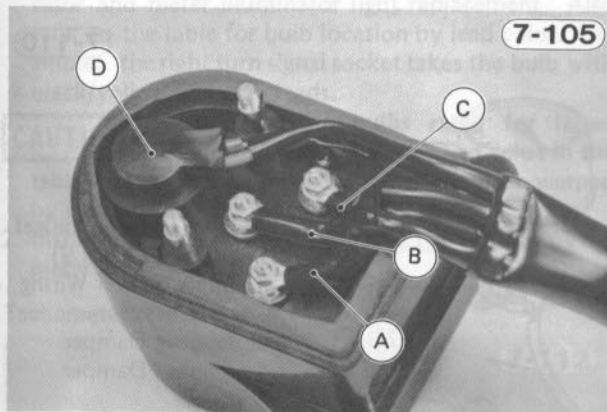

**A. Brown Lead**      **C. White/Yellow Lead**  
**B. Black/Yellow Lead**      **D. 12V 1.7W Bulb**

**Tachometer:**

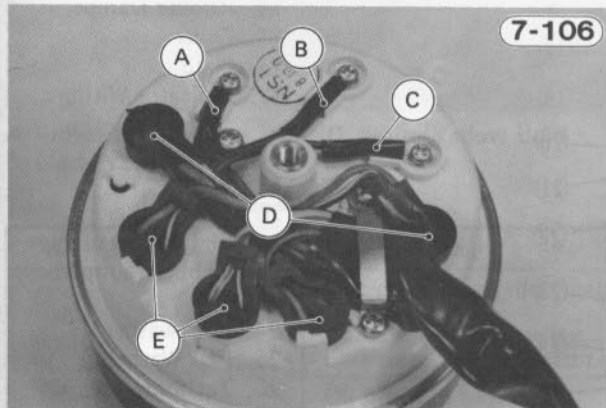

**A. Brown Lead**      **D. 12V 1.7W Bulbs**  
**B. Black/Yellow Lead**      **E. 12V 3.4W Bulbs**  
**C. Black Lead**

**Speedometer:**

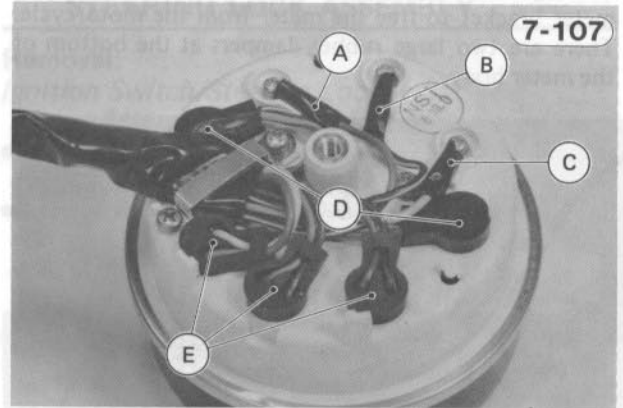

**A. Brown Lead**      **D. 12V 1.7W Bulbs**  
**B. Black/Yellow Lead**      **E. 12V 3.4W Bulbs**  
**C. Orange Lead**

3. Check the rubber dampers for damage. Replace the damaged dampers with the new ones.

**SPEEDOMETER  
TACHOMETER  
(all on KZ1000-M)**

**Removal:**

*Speedometer and Tachometer Removal*

**NOTE:** 1. The fuel gauge of the KZ1000-M is built in the tachometer. The fuel gauge cannot be removed from the tachometer.

- Remove the headlight unit (Pg. 7-27), and disconnect the meter connector in the headlight housing.
- Disconnect the upper end of the speedometer cable and tachometer cable with pliers.
- Remove the cap nuts (2) from the bottom of the meter, and remove the meter bottom cover. Two small dampers may fall off the studs.



**A. Cap Nut**      **B. Cover**

- Pull out the meter wiring harness through the headlight housing and meter bracket to free the meter from the meter bracket to free the meter from the motorcycle. There are two large rubber dampers at the bottom of the meter body.

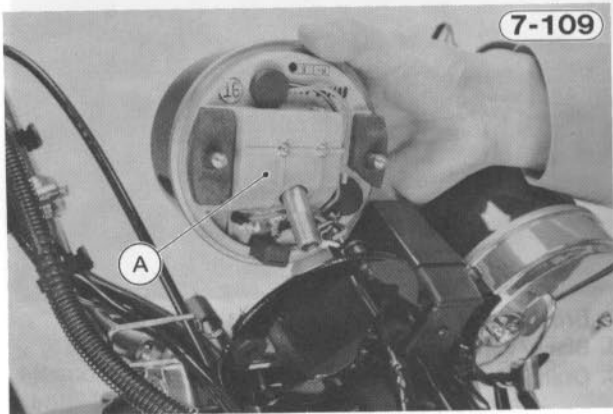

A. Meter

**CAUTION**

1. Place the meter so that the correct side of the meter is up. If a meter is left

Speedometer, Tachometer (KZ1000-M)

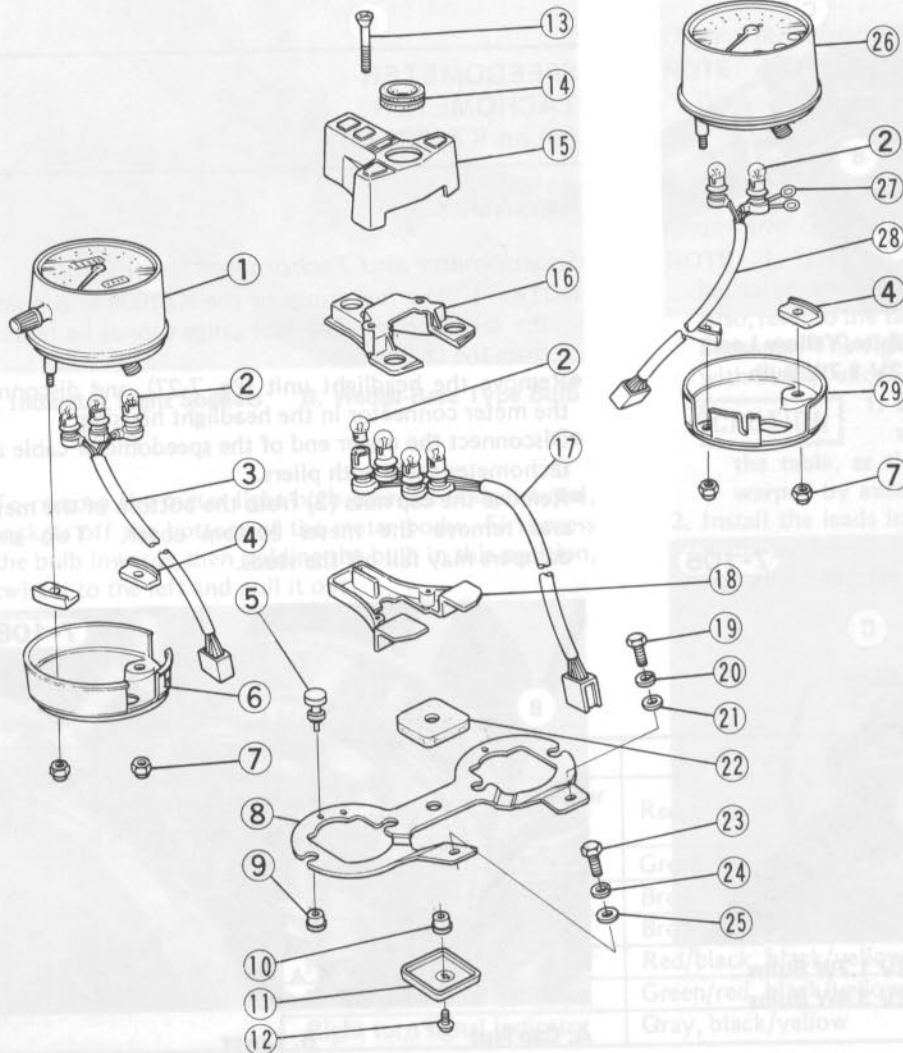

1. Speedometer
2. Bulb (normal midget type, 3.4W x 9)
3. Speedometer Wiring Harness
4. Rubber Damper
5. Rubber Damper
6. Cover
7. Cap Nut
8. Bracket
9. Rubber Damper
10. Rubber Damper
11. Cover
12. Screw
13. Screw
14. Rubber Damper
15. Cover
16. Plate
17. Indicator Wiring Harness
18. Cover
19. Bolt
20. Lockwasher
21. Flat Washer
22. Rubber Damper
23. Bolt
24. Lockwasher
25. Flat Washer
26. Tachometer
27. Fuel Gauge Leads
28. Tachometer Wiring Harness
29. Cover

upside down or sideways for any length of time it will malfunction.

**Installation:**

*Speedometer and Tachometer Installation*

- NOTE:** 1. Installation is the reverse of removal.  
2. Adjust the headlight aim.

**Meter Disassembly (including bulb replacement)**

*Meter Disassembly*

- To remove the meter light bulb and indicator light bulb (normal midget type), pull the bulb sockets off the bottom of the meter body. First press the bulb inward, then holding the bulb in this position, twist it to the left and pull it out.
- Remove the nuts and lockwashers (2 ea), and free the tachometer wiring harness from the meter.

*Indicator Panel Disassembly*

- Remove the mounting screws (2), and take off the upper cover.

7-110

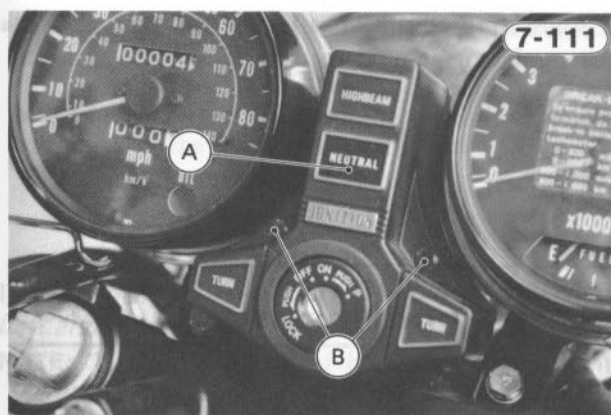

A. Upper Cover B. Screws

- To remove the indicator light bulb, first press the bulb inwards, then holding the bulb in this position, twist it to the left and pull it out.

### Meter Assembly:

#### Indicator Assembly

**NOTE:** 1. Use the bulbs shown in Table 7-3 for indicator and meter illuminator light replacement. Also refer to the table for bulb location by lead color. Example: the right turn signal socket takes the bulb with black/yellow and gray leads.

#### CAUTION

1. Do not use bulbs rated for larger wattage than the specified value in the table, as the meters or gauge panel could be warped by excessive heat radiated from the bulbs.
2. Install the leads in the position at the bottom of the meter as shown in Fig. 7-112.

#### Tachometer:

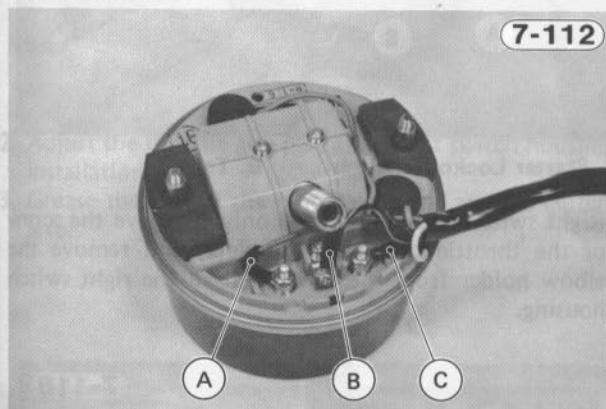

A. Brown Lead B. Black/Yellow Lead C. White/Yellow Lead

Table 7-3 Indicator and Meter Lights

Bulb Wattage and Type	Light	Lead Color
12V 3.4W (Normal midsize type)	Meter and gauge illuminator x 4	Red/blue, black/yellow
	Left turn signal indicator	Green, black/yellow
	Oil pressure warning	Brown, blue/red
	Neutral indicator	Brown, light green
	High beam indicator	Red/black, black/yellow
	Right turn signal indicator	Gray, black/yellow

## IGNITION SWITCH/ STEERING LOCK ASSEMBLY

### Removal:

#### Ignition Switch/Steering Lock Assembly Removal

- Remove the headlight unit (Pg. 7-27) and housing (Pg. 7-28).
- Remove the Allen bolts (2) and lockwashers (2), and pull out the ignition switch/steering lock assembly downward.

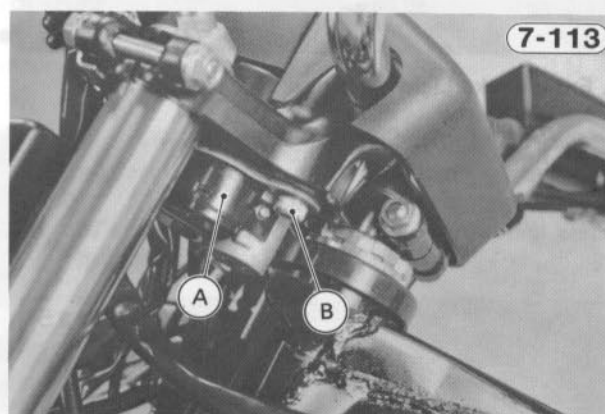

A. Ignition Switch/Steering Lock Assembly  
B. Allen Bolts

### Installation:

#### Ignition Switch/ Steering Lock Assembly Installation

- NOTE:** 1. Adjust the headlight aim after installation.

## BRAKE LIGHT SWITCHES

### Removal:

#### Front Brake Light Switch Removal

- Remove the headlight unit (Pg. 7-27).
- Disconnect the front brake light switch leads in the headlight housing, and pull the leads out of the housing.
- Using a thin-bladed screwdriver or some other suitable tool, press in the front brake light switch tab which catches in the hole in the underside of the master cylinder, and then pull out the switch.

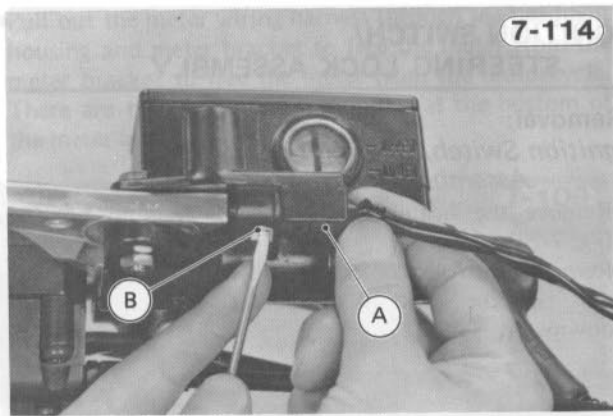

A. Front Brake Light Switch      B. Tab

### Rear Brake Light Switch Removal

- Remove the right side cover, and disconnect the leads from the rear brake light switch.
- Press in the rear brake light switch tabs, and take the rear brake light switch off the bracket and spring.

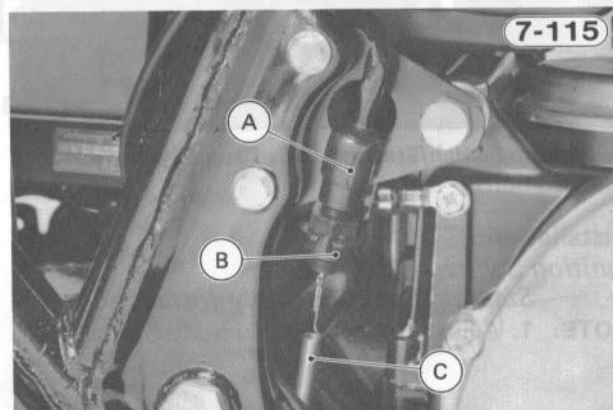

A. Rear Brake Light Switch      C. Spring  
B. Tab

### Installation:

#### Rear Brake Light Switch Installation

**NOTE:** 1. Adjust the rear brake light switch after installation.

#### Front Brake Light switch Installation

**NOTE:** 1. Grease the end of the switch push rod and the brake lever.

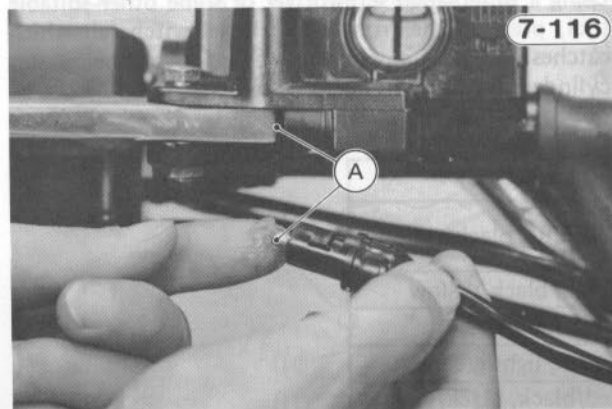

A. Grease.

2. Adjust the headlight aim after installation.

## HANDLEBAR SWITCH HOUSING STARTER LOCKOUT SWITCH

### Removal:

#### Left and Right Switch Housing Removal (including starter lockout switch removal)

- Remove the fuel tank (Pg. 6-5).
- Remove the straps which hold the switch housing harness to the handlebar.
- Disconnect the connector(s) and lead(s) which comes from the switch housing at the frame top tube.
- Left switch housing removal only: Using a thin-bladed screwdriver or some other suitable tool, press in the starter lockout switch tab which catches in the hole in the clutch lever holder, and then remove the switch.

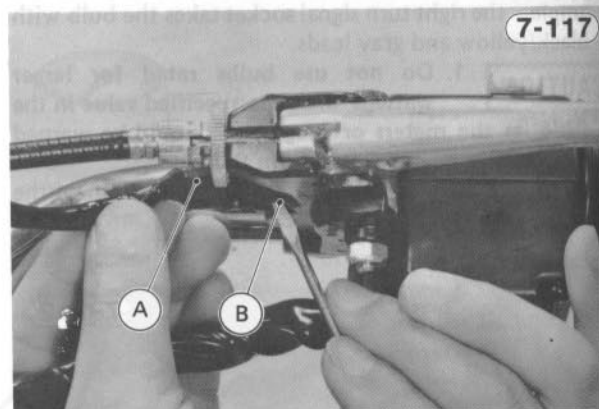

A. Starter Lockout Switch      B. Tab

- Right switch housing removal only: Remove the screw of the throttle cable elbow holder, and remove the elbow holder from the lower half of the right switch housing.

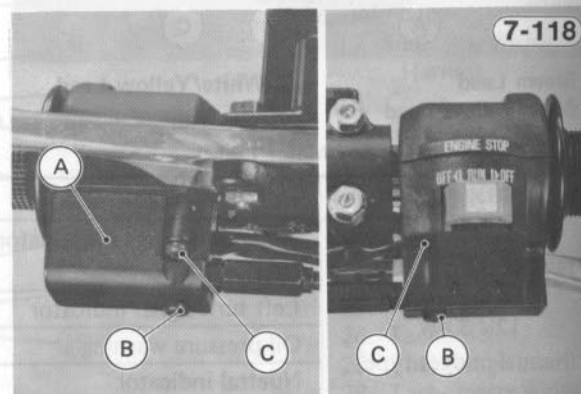

A. Elbow Holder      C. Switch Housing Screws  
B. Holder Screws

- Remove the switch housing screws (2), open the switch housing, and free the switch housing free from the motorcycle. If the clutch lever holder hinders the left switch housing opening; loosen the clutch lever holder bolt, and slide the clutch lever to the right.

### Installation:

#### Left and Right Switch Housing Installation

- NOTE:** 1. The lower half of both the left and right switch housings has a small projection. Fit the projection into a small hole in the handlebar.

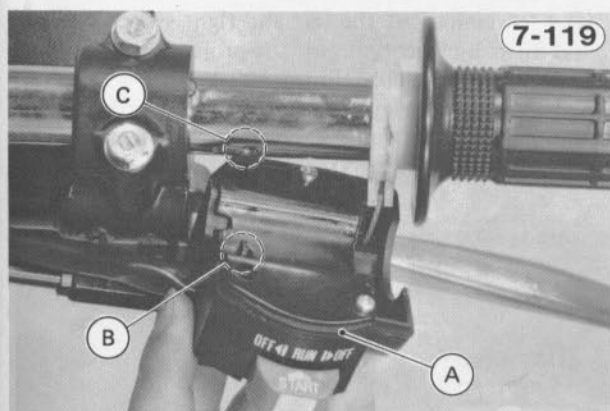

A. Switch Housing  
B. Small Projection  
C. Hole

2. Adjust the throttle grip play after right switch housing installation.
3. Grease the end of the switch push rod and the clutch lever.

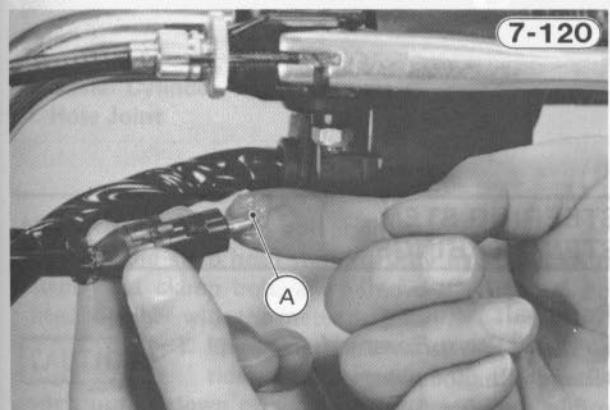

A. Grease.

## HANDLEBAR

### Removal:

#### Handlebar Removal

- Remove the fuel tank (Pg. 6-5), or cover it with a thick cloth to avoid damaging the painted surface.
- Remove the following parts from the handlebar.
  - Rear view mirrors
  - KZ/Z1000-K, KZ1000-M: Front turn signal assemblies (Pg. 7-30)
  - Clutch cable (Pg. 7-23)
  - Left switch housing (Pg. 7-39)
- Loosen the master cylinder clamp bolts (2)

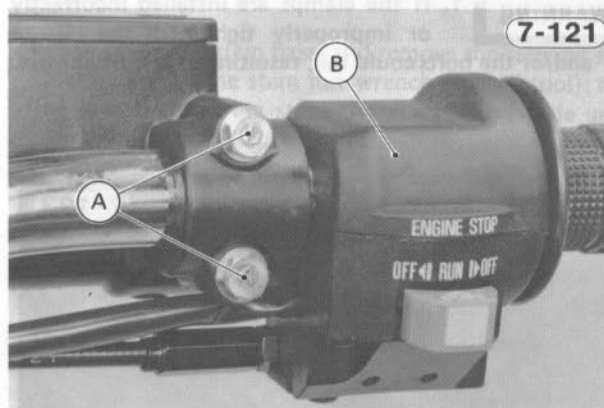

A. Master Cylinder Clamp Bolts  
B. Right Switch Housing

- Remove the right switch housing screws (2), and open up the housing.
- Disconnect the starter lockout switch from the clutch lever holder.
- Remove the screws, and take off the handlebar clamp cover.
- Remove the handlebar clamp bolts and lockwashers (4 ea), remove the clamps (2), and cover bracket, and slide the handlebar from the throttle grip, right switch housing, and master cylinder.

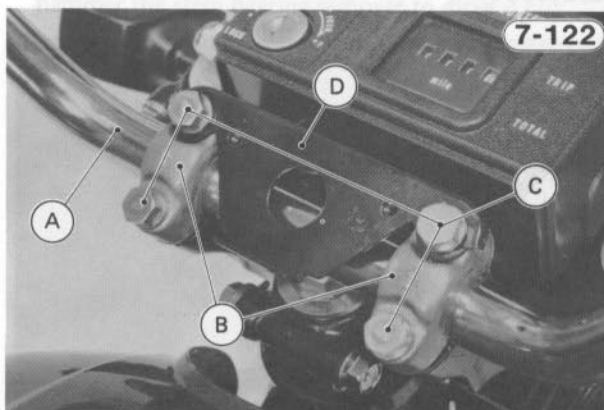

A. Handlebar  
B. Handlebar Clamps  
C. Clamp Bolts  
D. Cover Bracket

- To remove the clutch lever and lever holder assembly, loosen the clutch lever holder bolt, cut off the left handlegrip, which is bonded to the handlebar, and slide off the clutch lever and lever holder assembly.

### Installation:

#### Handlebar Installation

- NOTE:** 1. Install the handlebar clamps so that the arrow on the clamp points to the front.
2. Tighten first the front handlebar-clamp bolt and then the rear clamp bolt to 1.8 kg-m (13.0 ft-lbs) of torque. If the clamp is correctly installed, there will be no gap at the front and an even gap at the rear after tightening.

**WARNING** 1. If the clamps are installed incorrectly or improperly tightened, the clamps and/or the bolts could fail, resulting in loss of control.

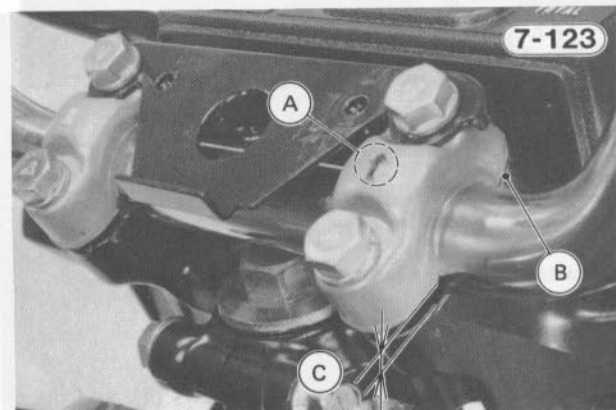

A. Arrow B. No Gap C. Even Gap

3. Install the handlebar so that it is at an angle with the front fork as shown in the figures.

#### KZ/Z1000-J:

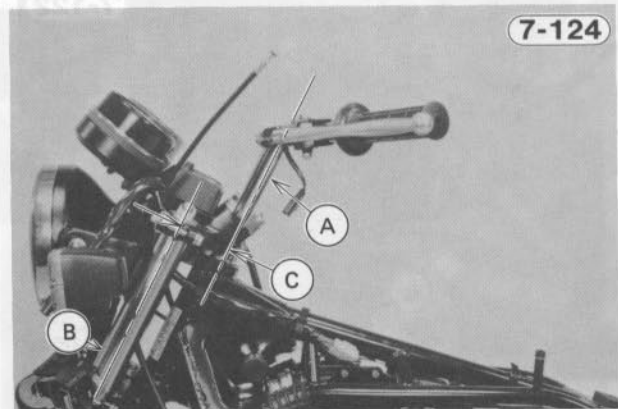

A. Handlebar B. Front Fork C. Parallel

#### KZ/Z1000-K, KZ1000-M:

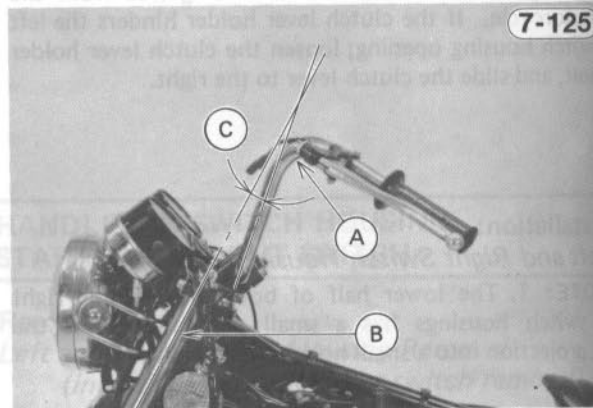

A. Handlebar B. Front Fork C. 10°

4. The lower half of the left and right switch housings has a small projection. Fit the projection into a small hole in the handlebar (Fig. 7-120).
5. With the brake lever mounted at the proper angle, tighten first the upper and then the lower master cylinder clamp bolt to 0.90 kg-m (78 in-lbs) of torque.

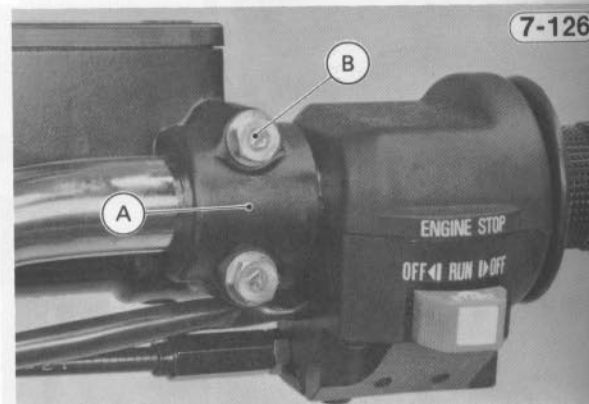

A. Master Cylinder Clamp B. Tighten first.

6. Check and adjust the following items:
- Front brake (Pg. 2-15)
  - Throttle grip play (Pg. 2-10)
  - Clutch (Pg. 2-12)
  - Rear view mirrors

## STEERING STEM STEM BEARINGS

### Removal:

#### Steering Stem Removal

- Remove the following parts
  - Fuel tank (Pg. 6-5)
  - Front wheel (Pg. 7-3)

- Headlight unit, housing, and bracket (Pg. 7-27)
- Handlebar (Pg. 7-39)
- Front fork (Pg. 7-42)
- KZ1000-M: Tachometer cable (Pg. 7-25)
- Remove the fork leg upper clamp bolts on both sides, and remove the cable and harness guides.
- Remove the screws (2), and take off the stem base cover.
- Remove the mounting bolts (2), take off the cover bracket, and free the brake hose joint from the stem base.

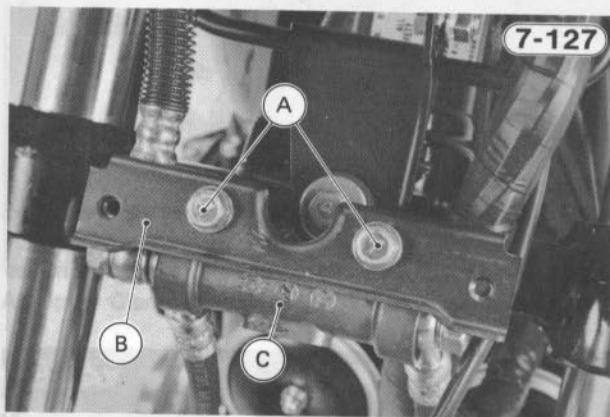

**A. Mounting Bolts**      **C. Hose Joint**  
**B. Cover Bracket**

- Remove the bolts, and free the remaining front brake caliper from the front fork leg.
- Remove the whole front brake assembly as a unit.

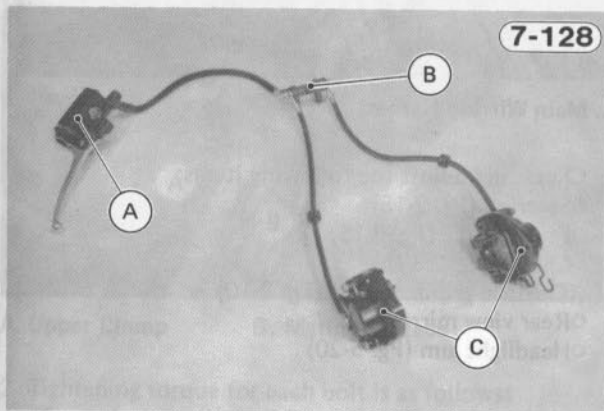

**A. Master Cylinder**      **C. Calipers**  
**B. Hose Joint**

- Remove the stem head bolt and flat washer.
- Holding the stem head stationary by hand, loosen the stem head clamp bolt, and remove the steering stem head together with the meter assembly.

**CAUTION** 1. Place the stem head so that the correct side of the meters are up. If a meter is left upside down or sideways for any length of time, it will malfunction.

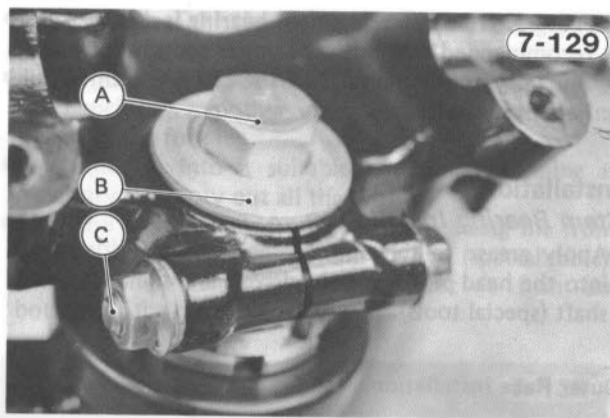

**A. Stem Head Bolt**      **C. Clamp Bolt**  
**B. Flat Washer**

- Push up on the stem base, and remove the steering stem locknuts with the stem nut wrench (special tool); then remove the steering stem and stem base (single unit).

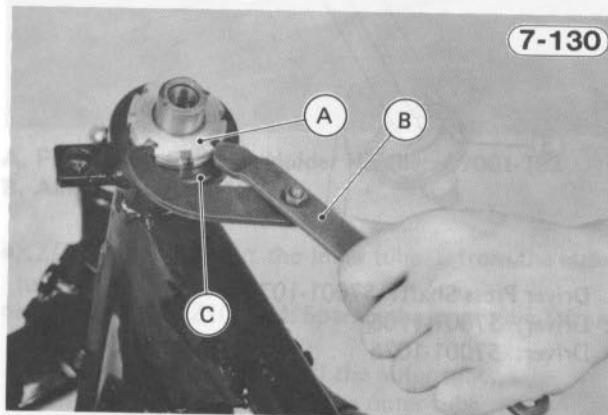

**A. Stem Locknuts**  
**B. Stem Nut Wrench: 57001-134 or 57001-1100**  
**C. Cap**

- Remove the steering stem cap and upper tapered roller bearing inner race.

#### Stem Bearing Removal

- To remove the outer races pressed into the head pipe, install the stem bearing remover as shown below, and hammer the stem bearing remover to drive it out.

#### Outer Race Removal

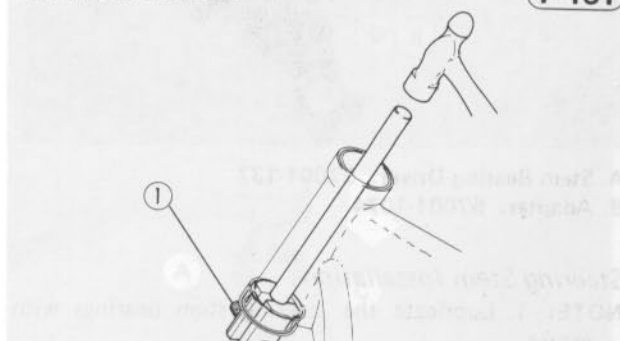

1. Stem Bearing Remover: 57001-1107



**NOTE.** 1. If any steering stem bearing is damaged, it is recommended that both the upper and lower bearings (including outer races) and the steering stem should be replaced with new ones.

### Installation:

#### Stem Bearing Installation

- Apply grease to the outer races, and then drive them into the head pipe using the drivers and the driver press shaft (special tools).

#### Outer Race Installation

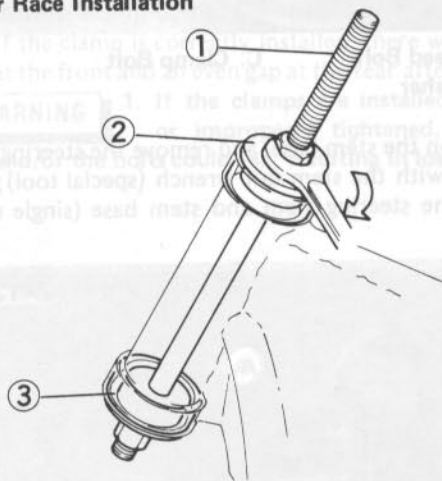

7-132

1. Driver Press Shaft: 57001-1075
2. Driver: 57001-1106
3. Driver: 57001-1076

- Apply grease to the tapered roller bearing, and drive it onto the steering stem using the stem bearing driver and adapter (special tools).

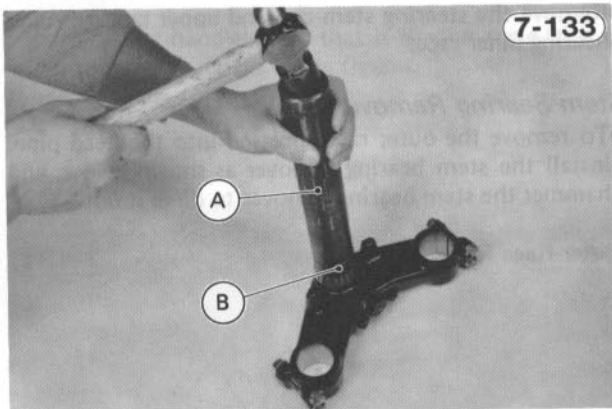

7-133

- A. Stem Bearing Driver: 57001-137
- B. Adapter: 57001-1074

#### Steering Stem Installation

- NOTE:** 1. Lubricate the steering stem bearings with grease.
2. Install the lower stem locknut so that the notched side faces down.

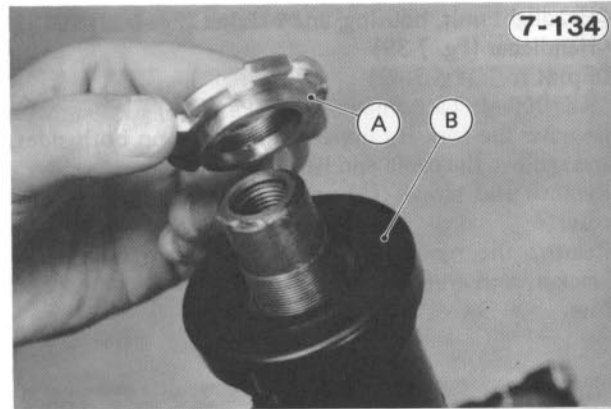

7-134

- A. Notch
- B. Cap

3. Install the front fork legs referring to the front fork "Installation Notes". See Pg. 7-43.
4. Route the cables and harnesses correctly. The main wiring harness goes between the steering stem base and the base cover bracket, and up through the headlight housing hole. The cables and wiring harnesses must not hinder handlebar movement.

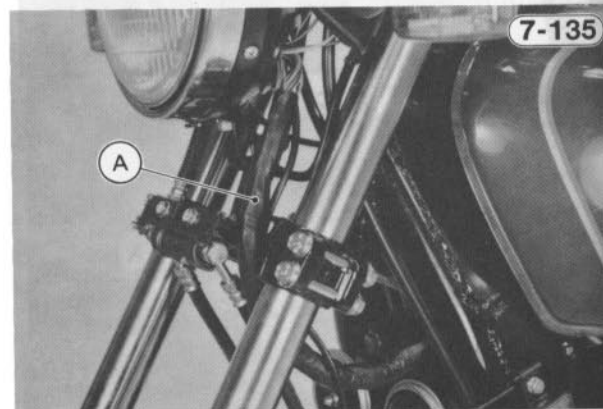

7-135

#### A. Main Wiring Harness

5. Check and adjust the following items:
  - Steering (Pg. 2-18)
  - Front brake (Pg. 2-15)
  - Clutch (Pg. 2-12)
  - Throttle grip free play (Pg. 2-10)
  - Rear view mirrors
  - Headlight aim (Pg. 5-20)

## FRONT FORK

### Removal:

#### Each Fork Leg Removal

- Remove the mounting bolts, take off the only caliper on the fork leg to be removed, and rest the caliper on some kind of stand so that it does not dangle.
- Remove the front wheel (Pg. 7-3).
- Remove the bolts and lockwashers (4 ea), and remove the front fender.

- If the fork leg is to be disassembled after removal, release the air through the air valve and loosen the top bolt now.
- Loosen the upper and lower clamp bolts (3) for the fork leg.
- With a twisting motion, work the fork leg down and out.

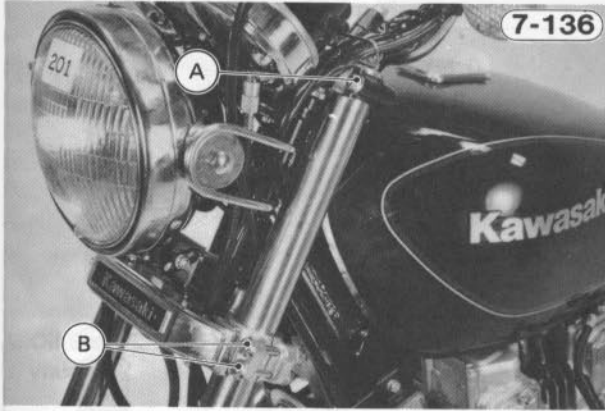

A. Upper Clamp Bolt      B. Lower Clamp Bolts

**Installation:**

*Each Fork Leg Installation*

**NOTE:** 1. Slide the fork leg up through the lower and upper clamps until the mating surface of the top bolt flange and the inner tube upper end is even with the upper surface of the upper clamp.

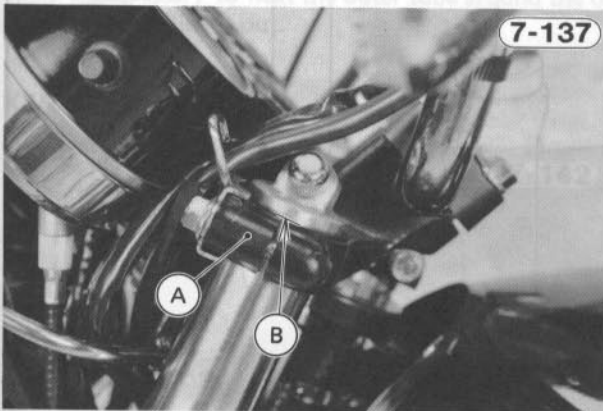

A. Upper Clamp      B. Mating Surface

2. Tightening torque for each bolt is as follows:
  - Front fork upper and lower clamp bolts: 1.8 kg-m (13.0 ft-lbs)
  - Front fork top bolt: 2.3 kg-m (16.5 ft-lbs)
3. Check the following items and adjust if necessary:
  - Front fork air pressure (Pg. 4-14)
  - Front brake (Pg. 2-15)

**Front Fork Disassembly and Assembly:**

*Front Fork Disassembly*

- Release the air through the air valve (17) before disassembling the fork leg.
- Remove the air valve (17) and its O-ring (18).
- Remove the top bolt (19) and O-ring (20).

- KZ/Z1000-J: Take the spring seat (23) and spring (24) out of the fork leg.
- KZ/Z1000-K, KZ1000-M: Take out the spring seat (21), short spring (22), another spring seat (23), and long spring (24) out of the fork leg.
- Pour the oil into a suitable container, pumping as necessary to empty out all the oil.
- Stop the cylinder (26) from turning by using the front fork cylinder holder handle and adapter (special tools). Unscrew the Allen bolt (15) and gasket (14) from the bottom of the outer tube (8).

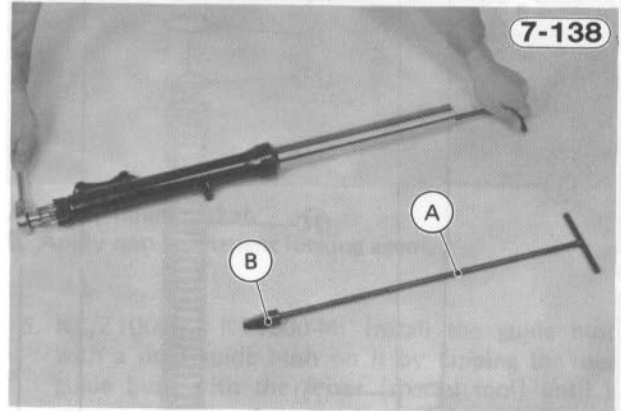

A. Front Fork Cylinder Holder Handle: 57001-183  
B. Adapter: 57001-1057

- KZ/Z1000-J: Pull out the inner tube (1) from the outer tube (1).
- KZ/Z1000-K, KZ1000-M: Separate the inner tube (1) from the outer tube (8) as follows.
  - Remove the dust seal (3) off the outer tube.
  - Remove the retainer (4) off the outer tube.
  - Holding the inner tube by hand and keeping the fork leg in a vertical position, top the outer tube on the upper end with the driver (special tool) until the outer tube falls off the inner tube. Face the big end of the driver downward.

**CAUTION** 1. To avoid damaging the inner tube guide bush (7), do not tap the outer tube when the fork leg is put horizontally on a work bench.

KZ/Z1000-K, KZ1000-M:

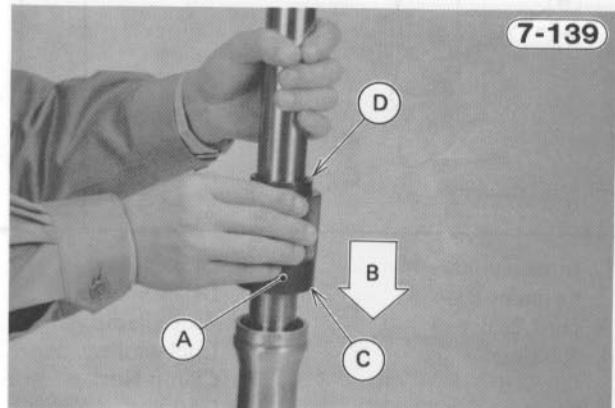

A. Driver: 57001-1104      C. Big End  
B. Tap.      D. Small End

Front Fork  
KZ/Z1000-J

KZ/Z1000-K, KZ1000-M

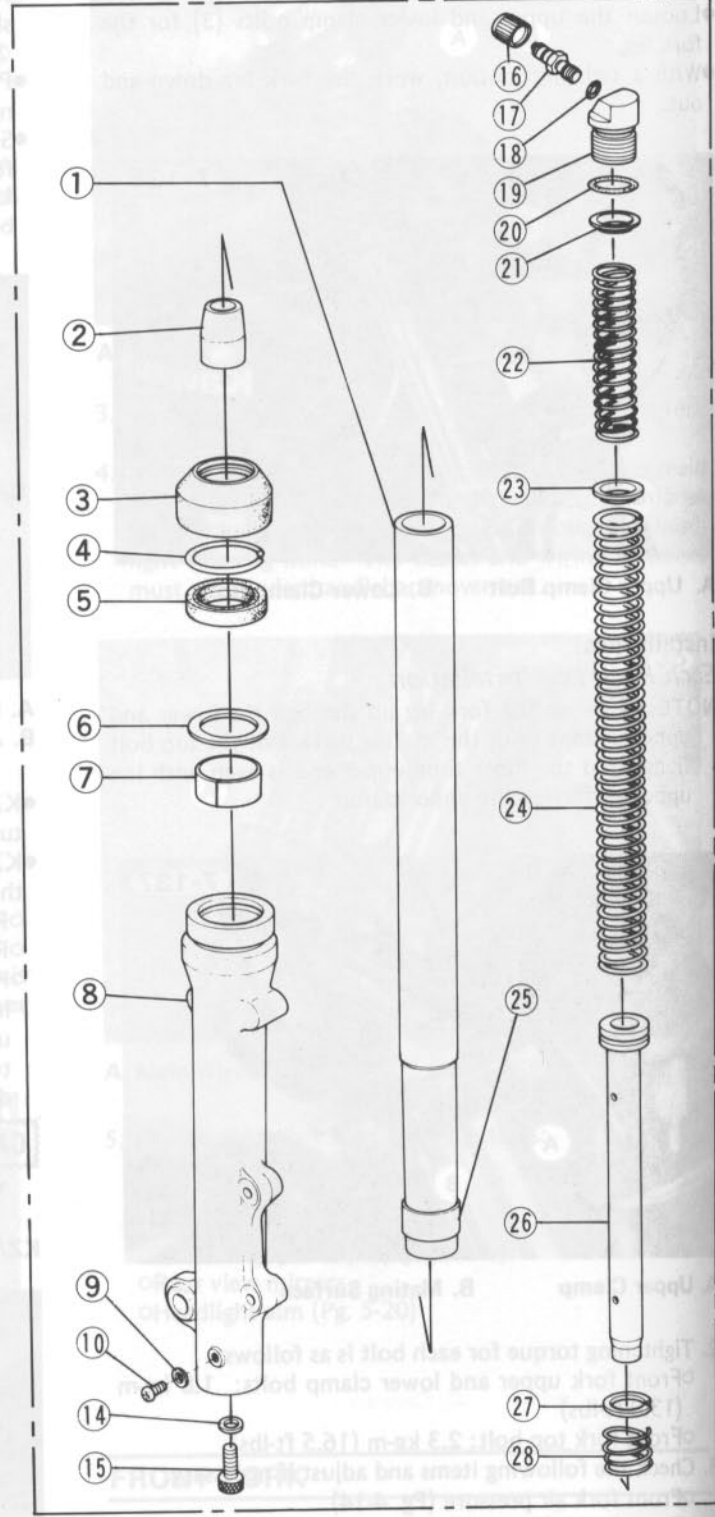
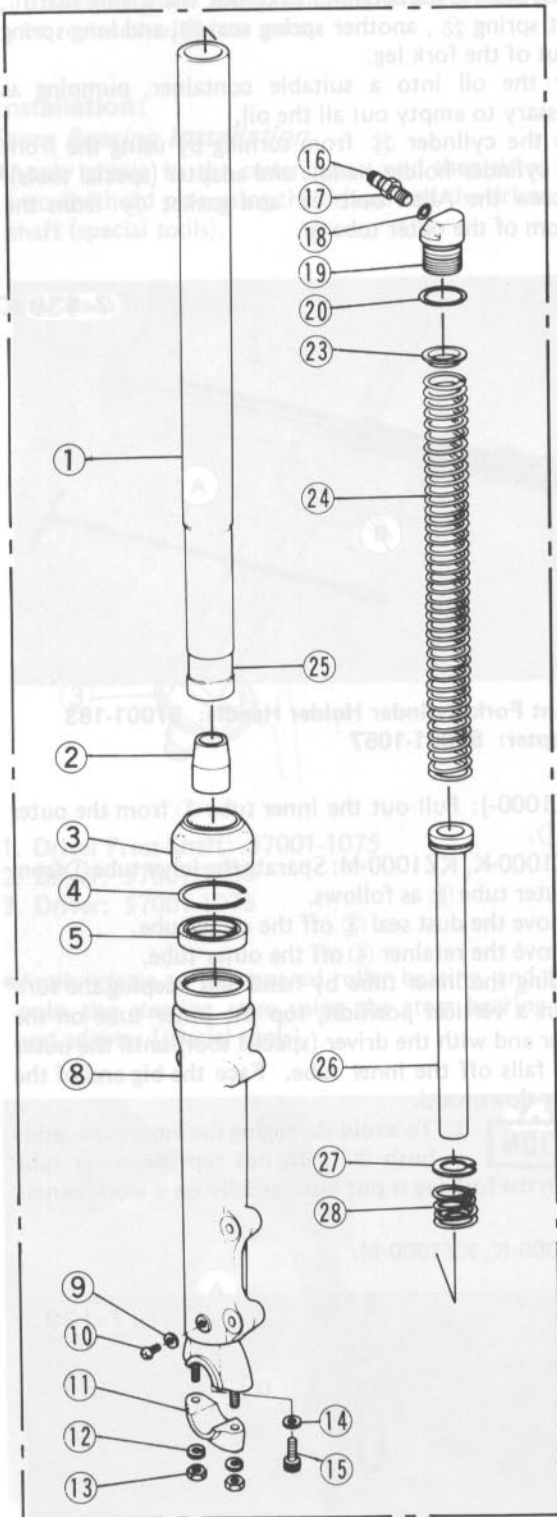

- 1. Inner Tube
- 2. Cylinder Base
- 3. Dust Seal
- 4. Retainer
- 5. Oil Seal
- 6. Washer
- 7. Guide Bush
- 8. Outer Tube
- 9. Gasket
- 10. Drian Screw
- 11. Axle Clamp
- 12. Lockwasher
- 13. Clamp Nut
- 14. Gasket
- 15. Allen Bolt

- 16. Cap
- 17. Air Valve
- 18. O-Ring
- 19. Top Bolt
- 20. O-Ring
- 21. Spring Seat
- 22. Short Spring
- 23. Spring Seat
- 24. Long Spring
- 25. Guide Bush
- 26. Piston and Cylinder Unit
- 27. Piston Ring
- 28. Spring

○Remove the oil seal ⑤, washer ⑥, and outer tube guide bush ⑦ from the inner tube.

**KZ/Z1000-K, KZ1000-M:**

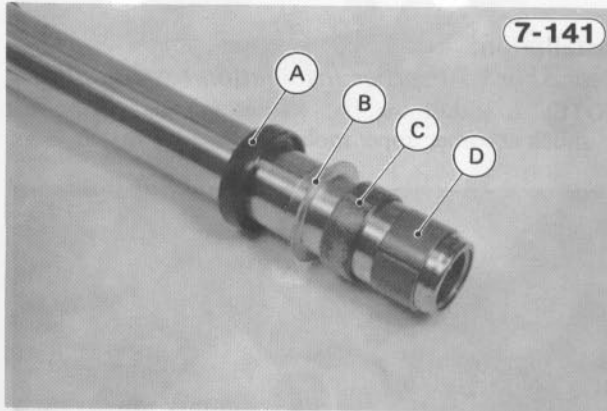

**A. Oil Seal**      **C. Outer Tube Guide Bush**  
**B. Washer**      **D. Inner Tube Guide Bush**

- Slide or push the piston and cylinder unit ⑳ and its spring ㉘ out the top of the inner tube.
- Remove the cylinder base ② out of the bottom of the outer tube.
- KZ/Z1000-J: Remove the dust seal ③ off the outer tube ⑧.
- KZ/Z1000-J: Remove the retainer ④ from the outer tube with a sharp hook, and pull out the oil seal ⑤. It may be necessary to heat the outer tube around the oil seal before pulling it out.

**KZ/Z1000-J:**

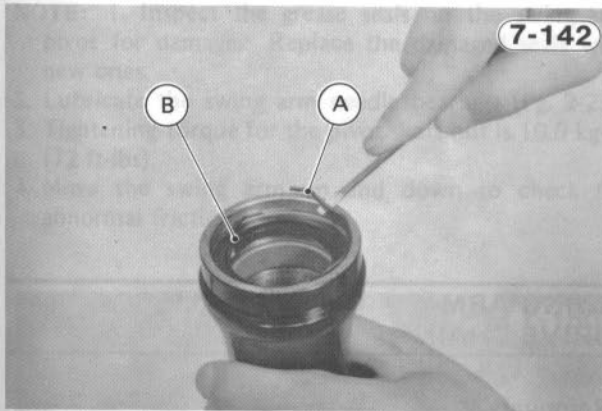

**A. Retainer**      **B. Oil Seal**

**Front Fork Assembly**

- NOTE:**
1. Check the O-rings and for damage. Replace them with new ones if damaged.
  2. Replace the removed oil seal with a new one.
  3. Inspect the guide bushes (Pg. 4-15), and replace them with new ones if necessary.
  4. Apply liquid gasket to both sides of the gasket ⑭, apply a non-permanent locking agent to the Allen bolt, and tighten it using the front fork cylinder

holder handle and holder adapter (special tools) to stop the cylinder from turning. The torque for the Allen bolt is 2.3 kg-m (16.5 ft-lbs).

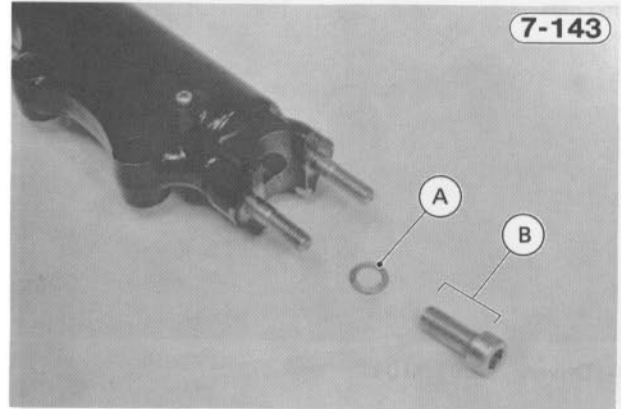

**A. Apply liquid gasket.**  
**B. Apply non-permanent locking agent.**

5. KZ/Z1000-K, KZ1000-M: Install the guide bush with a used guide bush on it by tapping the used guide bush with the driver (special tool) until it stops. The slit of the bush must faced toward the left or right.

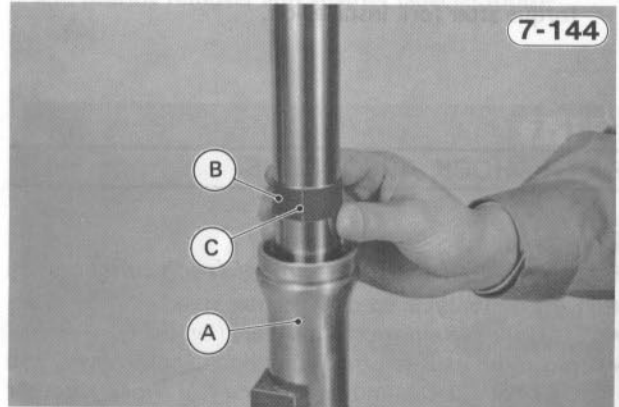

**A. Outer Tube**      **B. Guide Bush**      **C. Slit**

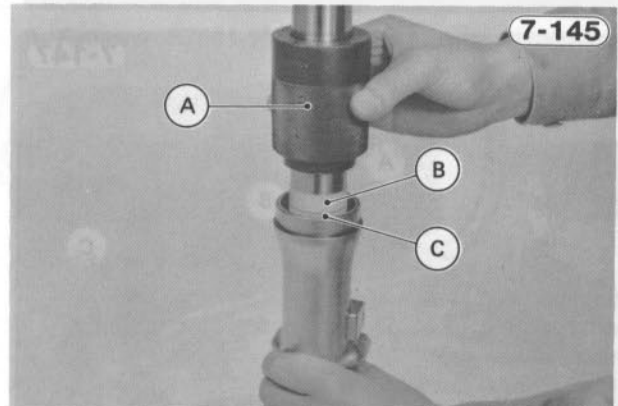

**A. Driver: 57001-1104**      **C. Guide Bush**  
**B. Used Guide Bush**

6. Install the oil seal with the driver (special tool).

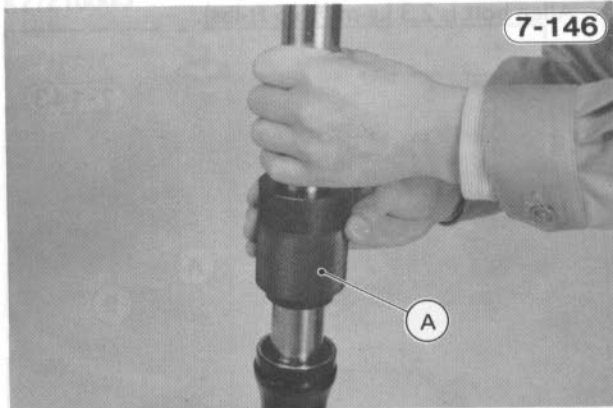

A. Driver: 57001-1104

7. Apply a non-permanent locking agent to the threads of the air valve, and tighten the valve to 0.80 kg-m (69 in-lbs) of torque.
8. If the drain screw is removed, check the gasket ⑨ for damage. Replace the damaged gasket with a new one. Before installing the drain screw, apply a liquid gasket to the threads of the screw, and tighten the screw securely.
9. Pour in the type and amount of fork oil specified in Table 2-13 on Pg. 2-21, and adjust the oil level.
10. Tighten the top bolt ⑩ to 2.3 kg-m (16.5 ft-lbs) of torque after fork installation.

## REAR SHOCK ABSORBERS

### Removal:

#### Rear Shock Absorber Removal (each unit)

- Set the motorcycle up on its center stand.
- KZ/Z1000-J: Remove the mufflers (Pg. 6-14).
- Remove the grab rail mounting bolts, lockwashers, and flat washers (2 ea), and remove the rear shock absorber upper mounting cap nuts, lockwashers, and flat washers (2 ea).
- Pull the grab rail toward the rear.

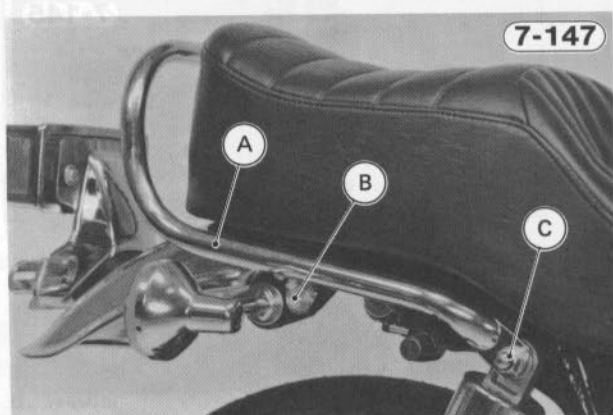

A. Grab Rail      B. Mounting Bolt      C. Cap Nut

- Lift up on the rear wheel as necessary to avoid damaging the screw threads of the shock absorber lower mounting bolt, and remove the mounting bolt and lockwasher.
- Pull off the rear shock absorber.

### Installation:

#### Rear Shock Absorber Installation (each unit)

- NOTE: 1. Install the flat washer outside of the rear shock absorber upper mounting lug.

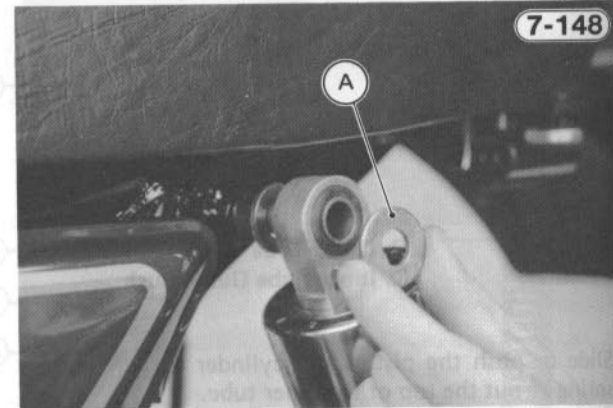

A. Flat Washer

2. Tighten the shock absorber mounting bolt and nut to 3.1 kg-m (22 ft-lbs) of torque.
3. Check to see that the left and right spring adjusting sleeves and damper adjusters are turned to the same relative positions.

### WARNING

1. If the left and right spring adjusting sleeves and damper adjusters are not adjusted equally, handling may be impaired and a hazardous condition may result.

## SWING ARM DRIVE CHAIN

### Removal:

#### Swing Arm Removal

- Set the motorcycle up on its center stand.
- KZ/Z1000-J: Remove the mufflers (Pg. 6-14).
- Remove the rear wheel (Pg. 7-7).
- Pull the rear brake hose out of the guides on the swing arm, remove the torque link rear bolt, and rest the rear caliper on some kind of stand.
- Remove the lower mounting bolt for each shock absorber. A lockwasher comes off with the bolt.
- Remove the pivot shaft nut and pull out the pivot shaft.
- Pull back the swing arm.

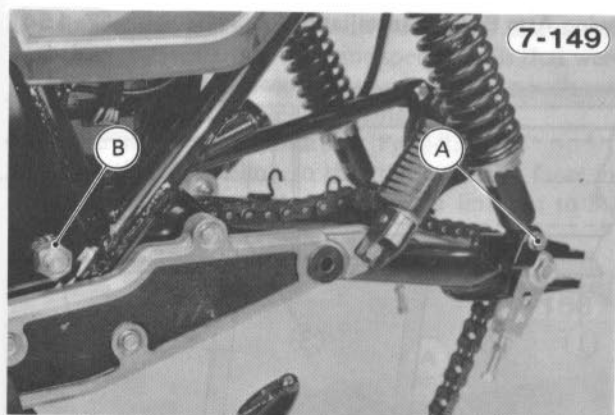

**A. Mounting Bolts (left and right)**  
**B. Pivot Bolt Nut**

### Drive Chain Removal

**WARNING** 1. The chain must not be cut for installation, as this may result in subsequent chain failure and loss of control.

- Remove the engine sprocket cover (Pg. 6-28).
- Holding the engine sprocket steady with the holder (special tool), remove the engine sprocket bolt (Fig. 6-89 on Pg. 6-29), and remove the engine sprocket and the drive chain.

### Installation:

#### Drive Chain Installation

**NOTE:** 1. Tightening torque for the engine sprocket bolt is 8.5 kg-m (61 ft-lbs).

#### Swing Arm Installation

- NOTE:** 1. Inspect the grease seals on the swing arm pivot for damage. Replace the damaged seals with new ones.
2. Lubricate the swing arm needle bearings (Pg. 2-23).
  3. Tightening torque for the pivot shaft nut is 10.0 kg-m (72 ft-lbs).
  4. Move the swing arm up and down to check for abnormal friction.

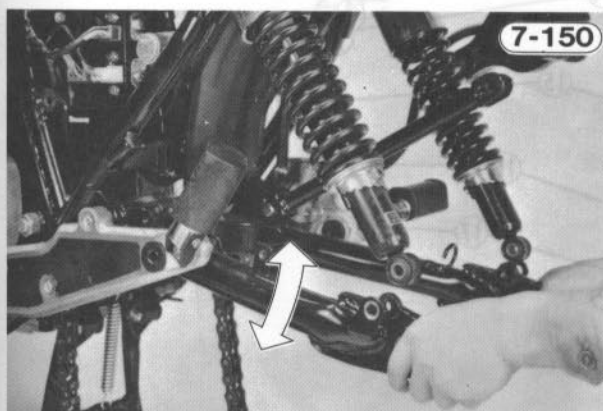

5. Adjust the drive chain (Pg. 2-13) after installation.

### Swing Arm Disassembly and Assembly

#### Swing Arm Disassembly

- Pull the sleeve ④ out of each side of the swing arm.
- Take out the torque link nut ⑩, lockwasher ⑨, and bolt ⑧, and then remove the torque link ⑪ from the swing arm ⑤.
- Pry the grease seals ② off the swing arm.

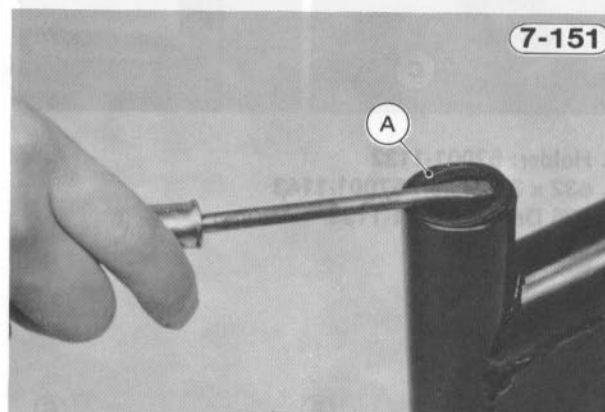

**A. Grease Seal**

- Pull out the needle roller bearings ③ using the oil seal and bearing remover and adapter (special tools).

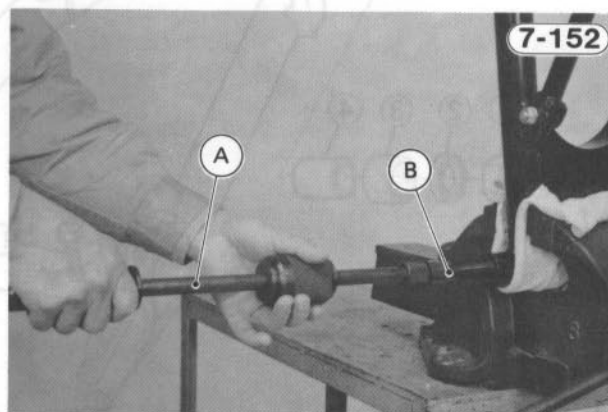

**A. Remover: 57001-1058**

**B. Adapter: 57001-1061**

- Pull the distance collar ⑥ out of the swing arm.

#### Swing Arm Assembly

- NOTE:** 1. Put the distance collar into the swing arm after the needle bearing on one side is installed.
2. Install new needle bearings in the swing arm using the bearing driver holder and adapters (special tools). Apply oil to the outside surface of the bearings, and press in each bearing so that it sinks 5 mm from the end of the bearing housing.

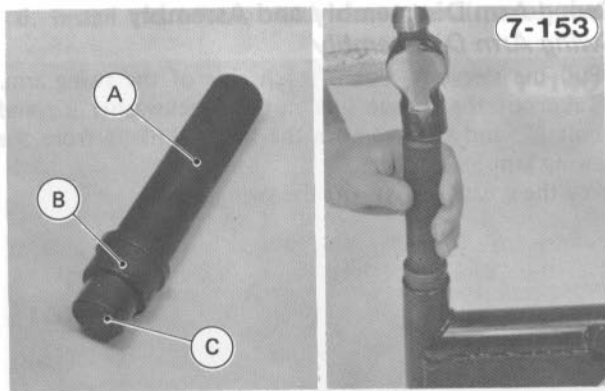

7-153

- A. Holder: 57001-1132
- B.  $\phi 32 \times 35$  Driver: 57001-1143
- C.  $\phi 25$  Driver: 57001-1139

Swing Arm Bearing Installation

7-154

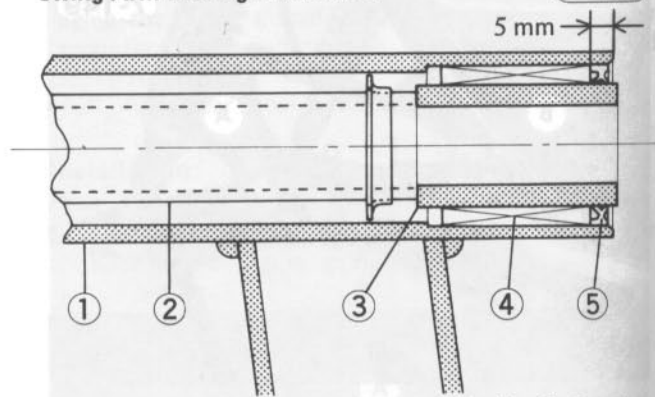

- 1. Swing Arm
- 2. Distance Collar
- 3. Sleeve
- 4. Needle Bearing
- 5. Grease Seal

Swing Arm

7-155

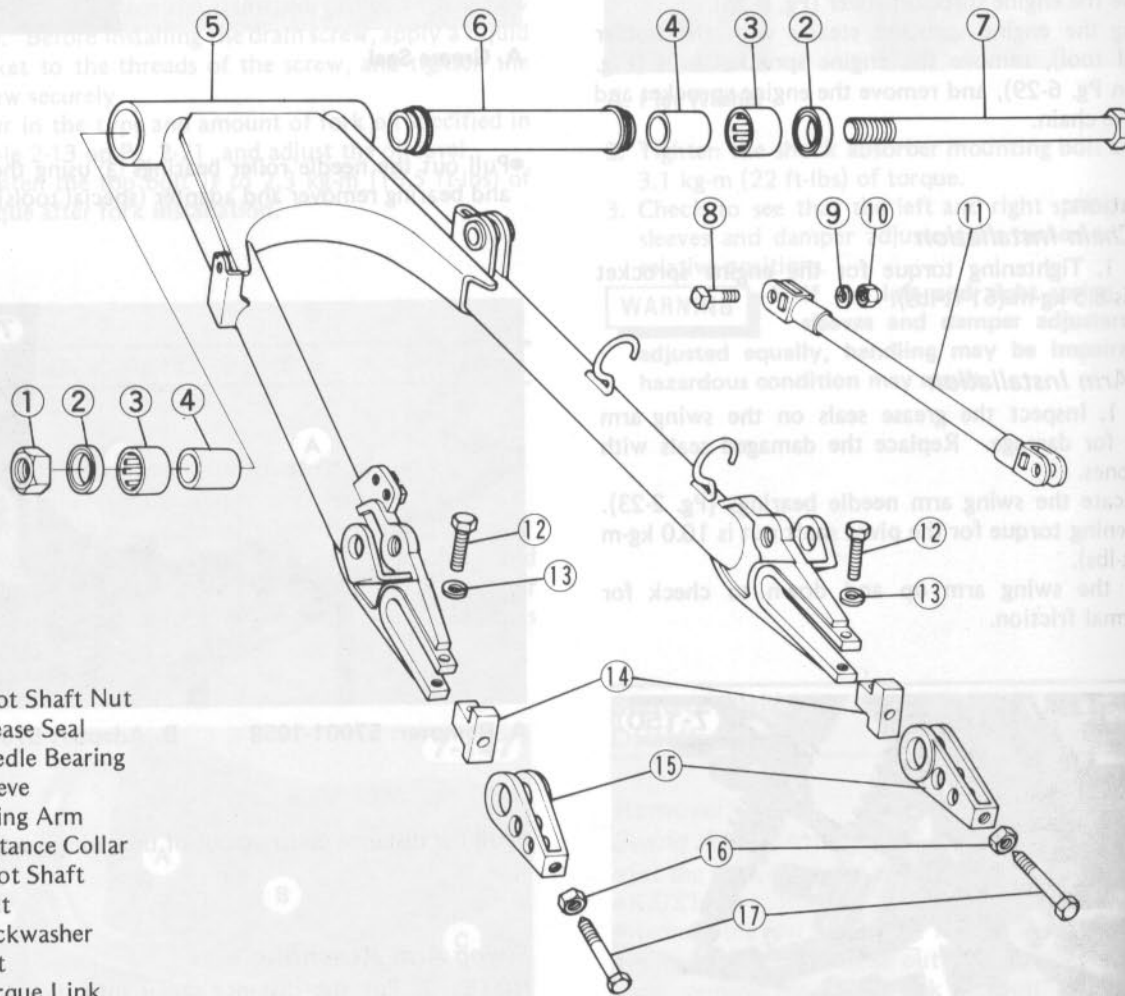

- 1. Pivot Shaft Nut
- 2. Grease Seal
- 3. Needle Bearing
- 4. Sleeve
- 5. Swing Arm
- 6. Distance Collar
- 7. Pivot Shaft
- 8. Bolt
- 9. Lockwasher
- 10. Nut
- 11. Torque Link
- 12. Bolt
- 13. Lockwasher
- 14. Stop
- 15. Chain Adjuster
- 16. Locknut
- 17. Adjusting Bolt

3. Replace the grease seals with new ones, and install each grease seal using the same special tools that were used to install the needle bearings. Press in each seal until it stops at the needle bearing.
4. Grease the swing arm bearings (Pg. 2-23).
5. Install the torque link so that the bolt stop faces in. After installation tighten the torque link nut to 3.1 kg-m (22 ft-lbs) of torque.

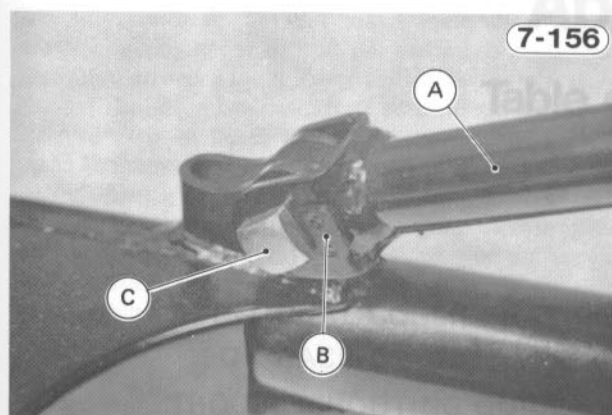

**A. Torque Link**      **C. Torque Link Bolt**  
**B. Bolt Stop**



ADDITIONAL CONSIDERATIONS FOR RACING

For the models other than the 125 model, the amount of adjustment can be made by changing the position of the needle. There are two grooves at the top of the needle. Changing the position of the tip to a new groove will change the fuel mixture which will affect the engine's performance. The choice of the groove to use depends on the engine's condition.

The spark plug ignites the fuel mixture in the combustion chamber. To do this effectively and at the correct time, the correct spark plug must be used, and the plug must be kept clean and adjusted.

Test have shown the plugs listed in the "SPARK PLUGS" section in the "Scheduled Maintenance" chapter to be the best choice for your motorcycle. No other spark plug gives the same performance with the engine and does not give the same results with the engine.

When the motorcycle is used for racing, the engine will be subjected to high temperatures and high speeds. The carbon burned on the plug will be harder to keep from building up. This is why the correct plug is so important.

The correct plug for racing is the B8HS. The B8HS plug is about 400 - 500°C (750 - 900°F) in temperature. The B8HS plug is made of a special material that can withstand the high temperatures and does not give the same results with the engine.

If the spark plug we replace with a type that would be different from the one that was used, we should be sure that the new plug has the same thread pitch and the same diameter as the old plug.

If the spark plug is too short, carbon will build up on the top of the plug and the threads in the head will be damaged. This will cause the engine to run poorly and will shorten the life of the plug.

If the spark plug is too long, it will not fit in the head and will cause the engine to run poorly. It will also cause the head to overheat and will shorten the life of the plug.

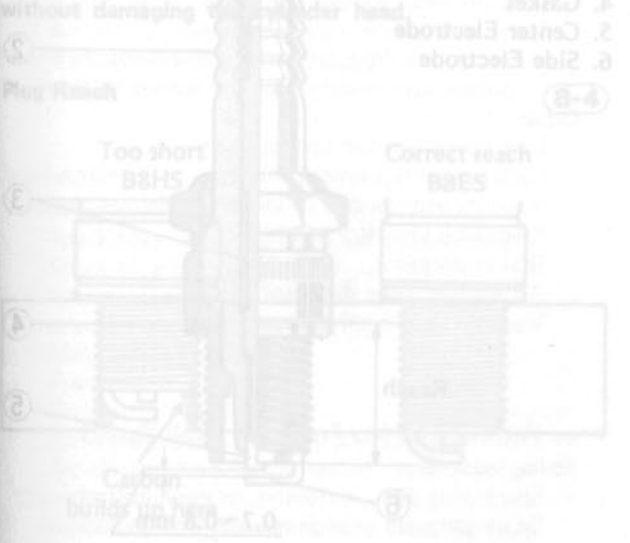

# Appendix

## Table of Contents

ADDITIONAL CONSIDERATIONS FOR RACING ..... 8-2

TROUBLESHOOTING GUIDE ..... 8-4

UNIT CONVERSIONS ..... 8-8

This motorcycle has been manufactured in a responsible manner and is subject to normal wear and tear. However, some of the subject matter in this manual may be subject to change without notice. KAWASAKI MOTORCYCLE COMPANY, LTD. TEL. RIDERS RITE. OBEY ALL LAWS AND REGULATIONS CONCERNING THEIR MOTORCYCLE AND ITS OPERATION. Racing should be done under supervision and recognized sanctioning bodies should be contacted for further details. For those who desire to participate in competitive racing or related use, the following technical information may prove helpful. However, please note the following important points: You are entirely responsible for the use of your motorcycle under abnormal conditions such as racing and Kawasaki shall not be liable for any damage which might arise from such use.

Kawasaki's Limited Motorcycle Warranty and Emission Control System Warranty, specifically as clubs motorcycle which are used in competitive or related use. Motorcycle racing is a very sophisticated sport, subject to many variables. The following information is theoretical only, and Kawasaki shall not be liable for any damage which might arise from alterations using this information. When the motorcycle is operated on public roads, it must be in its original state in order to ensure safety and compliance with applicable emission regulations.

Carburetor: Sometimes an alteration may be desirable for improved performance under special conditions when proper mixture is not obtained after the carburetor has been properly adjusted, and all parts cleaned and found to be functioning properly.

If the engine still exhibits symptoms of overly lean mixture after all maintenance and adjustments are correctly performed, the main jet can be replaced with a smaller or larger one. A smaller numbered jet gives a leaner mixture and a larger numbered jet a richer mixture.

Jet Needle: The jet needle is a tapered needle that fits into the carburetor. It is used to spray the fuel into the cylinder. The jet needle is made of a special material that can withstand the high temperatures and does not give the same results with the engine.

The jet needle is made of a special material that can withstand the high temperatures and does not give the same results with the engine. It is used to spray the fuel into the cylinder.

The jet needle is made of a special material that can withstand the high temperatures and does not give the same results with the engine. It is used to spray the fuel into the cylinder.

The jet needle is made of a special material that can withstand the high temperatures and does not give the same results with the engine. It is used to spray the fuel into the cylinder.

The jet needle is made of a special material that can withstand the high temperatures and does not give the same results with the engine. It is used to spray the fuel into the cylinder.

The jet needle is made of a special material that can withstand the high temperatures and does not give the same results with the engine. It is used to spray the fuel into the cylinder.

The jet needle is made of a special material that can withstand the high temperatures and does not give the same results with the engine. It is used to spray the fuel into the cylinder.

The jet needle is made of a special material that can withstand the high temperatures and does not give the same results with the engine. It is used to spray the fuel into the cylinder.

## ADDITIONAL CONSIDERATIONS FOR RACING

This motorcycle has been manufactured for use in a reasonable and prudent manner and as a vehicle only. However, some may wish to subject this motorcycle to abnormal operation, such as would be experienced under racing conditions. **KAWASAKI STRONGLY RECOMMENDS THAT ALL RIDERS RIDE SAFELY AND OBEY ALL LAWS AND REGULATIONS CONCERNING THEIR MOTORCYCLE AND ITS OPERATION.**

Racing should be done under supervised conditions, and recognized sanctioning bodies should be contacted for further details. For those who desire to participate in competitive racing or related use, the following technical information may prove useful. However, please note the following important points.

- You are entirely responsible for the use of your motorcycle under abnormal conditions such as racing, and Kawasaki shall not be liable for any damages which might arise from such use.
- Kawasaki's Limited Motorcycle Warranty and Limited Emission Control Systems Warranty specifically exclude motorcycles which are used in competitive or related uses. Please read the warranty carefully.
- Motorcycle racing is a very sophisticated sport, subject to many variables. The following information is theoretical only, and Kawasaki shall not be liable for any damages which might arise from alterations utilizing this information.
- When the motorcycle is operated on public roads, it **must** be in its original state in order to ensure safety and compliance with applicable emission regulations.

### Carburetors:

Sometimes an alteration may be desirable for improved performance under special conditions when proper mixture is not obtained after the carburetor has been properly adjusted, and all parts cleaned and found to be functioning properly.

If the engine still exhibits symptoms of overly lean carburetion after all maintenance and adjustments are correctly performed, the main jet can be replaced with a smaller or larger one. A smaller numbered jet gives a leaner mixture and a larger numbered jet a richer mixture.

### Jet Needle

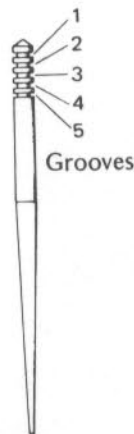

8-1

For the models other than the US model, a certain amount of adjustment can be made by changing the position of the needle. There are five grooves at the top of the needle. Changing the position of the clip to a groove closer to the bottom raises the needle, which makes the mixture richer at a given position of the throttle valve.

### Spark Plugs:

The spark plugs ignite the fuel/air mixture in the combustion chamber. To do this effectively and at the proper time, the correct spark plugs must be used, and the spark plugs must be kept clean and adjusted.

Test have shown the plugs listed in the "SPARK PLUGS" section in the "Scheduled Maintenance" chapter to be the best plug for general use.

Since spark plug requirements change with the ignition and carburetion adjustments and with riding conditions, whether or not spark plugs of a correct heat range are used should be determined by removing and inspecting the plugs.

When a plug of the correct heat range is being used, the electrodes will stay hot enough to keep all the carbon burned off, but cool enough to keep from damaging the engine and the plug itself. This temperature is about 400 ~ 800°C (750 ~ 1,450°F) and can be judged by noting the condition and color of the ceramic insulator around the center electrode. If the ceramic is clean and of a light brown color, the plug is operating at the right temperature.

### Spark Plug

8-2

1. Terminal
2. Insulator
3. Cement
4. Gasket
5. Center Electrode
6. Side Electrode

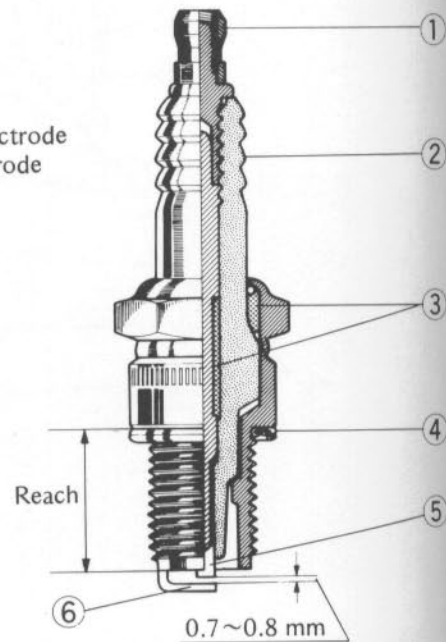

**Spark Plug Condition**

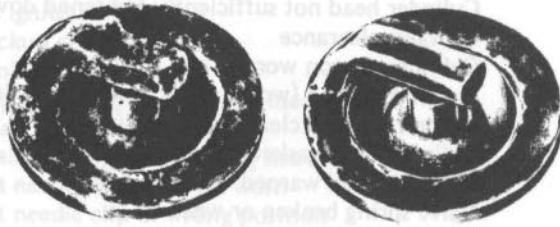

Carbon Fouling

Oil Fouling

The carbon on the electrodes conducts electricity, and can short the center electrode to ground by either coating the ceramic insulator or bridging across the gap. Such a short will prevent an effective spark. Carbon build-up on the plug can also cause other troubles. It can heat up red-hot and cause preignition and knocking, which may eventually burn a hole in the top of the piston.

**Spark Plug Inspection**

- Remove each plug and inspect the ceramic insulator.
- ★ Whether or not the right temperature plug is being used can be ascertained by noting the condition of the ceramic insulator around the electrode. A light brown color indicates the correct plug is being used.

**CAUTION** If the spark plugs are replaced with a type other than those mentioned below, make certain the replacement plugs have the same thread pitch and reach (length of threaded portion) as the standard plugs.

If the plug reach is too short, carbon will build up on the plug hole threads in the cylinder head, causing overheating and making it very difficult to insert the correct spark plug later.

If the reach is too long, carbon will build up on the exposed spark plug threads causing overheating, preignition, and possibly burning a hole in the piston top. In addition, it may be impossible to remove the plug without damaging the cylinder head.

**Plug Reach**

8-4

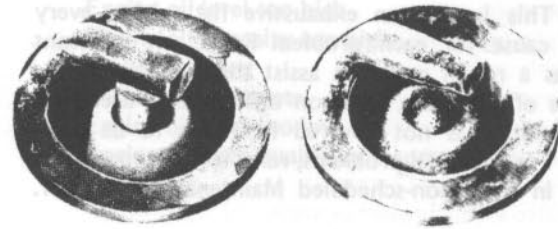
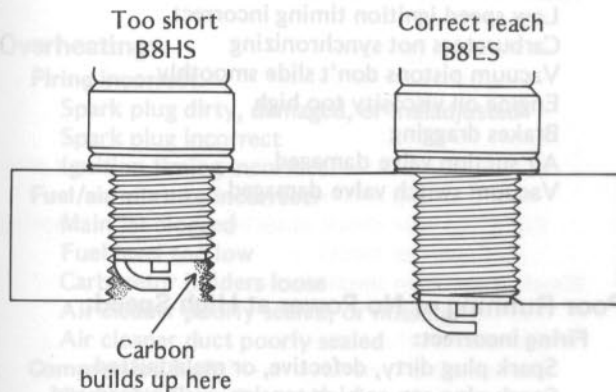

Normal Operation

Overheating

**Table 8-1 Spark Plug Threads**

Diameter	14 mm
Pitch	1.25 mm
Reach	19.0 mm

## TROUBLESHOOTING GUIDE

**NOTE:** This is not an exhaustive list, giving every possible cause for each problem listed. It is meant simply as a rough guide to assist the troubleshooting for some of the more common difficulties. Electrical troubleshooting is not covered here due to its complexity. For electrical problems, refer to the appropriate heading in the "Non-scheduled Maintenance" chapter.

### Engine Doesn't Start; Starting Difficulty:

#### Starter motor not rotating:

- Clutch lever not pulled
- Starter motor damaged
- Battery voltage low
- Relay not contacting or operating
- Starter button not contacting
- Wiring open or shorted
- Ignition switch damaged
- Engine stop switch damaged
- Engine stop switch off
- Fuse blown
- Starter lock out switch damaged

#### Starter motor rotating but engine doesn't turn over:

- Starter motor clutch damaged
- Alternator rotor bolt loosened

#### Engine won't turn over:

- Valve seizure
- Valve lifter seizure
- Cylinder, piston seizure
- Crankshaft seizure
- Connecting rod small end seizure
- Connecting rod big end seizure
- Transmission gear or bearing seizure
- Camshaft seizure
- Primary reduction gear broken

#### No fuel flow:

- No fuel in tank
- Fuel tap turned off
- Tank cap air vent obstructed
- Fuel tap clogged
- Fuel line clogged
- Float valve clogged

#### Engine flooded:

- Fuel level too high
- Float valve worn or stuck open
- Starting technique faulty  
(When flooded, crank the engine with the throttle fully open to allow more air to reach the engine.)

#### No spark; spark weak:

- Ignition switch not on
- Engine stop switch turned off
- Battery voltage low
- Spark plug dirty, damaged, or maladjusted
- Spark plug cap or high tension wiring damaged
- Spark plug cap not in good contact
- IC igniter damaged
- Pickup coil damaged
- Ignition coil damaged
- Ignition or engine stop switch shorted
- Wiring shorted or open

#### Compression low:

- Spark plug loose
- Cylinder head not sufficiently tightened down
- No valve clearance
- Cylinder, piston worn
- Piston rings bad (worn, weak, broken, or sticking)
- Piston ring/land clearance excessive
- Cylinder head gasket damaged
- Cylinder head warped
- Valve spring broken or weak
- Valve not seating properly (valve bent, worn, or carbon accumulation on the seating surface)

### Poor Running at Low Speed:

#### Spark weak:

- Battery voltage low
- Spark plug dirty, defective, or maladjusted
- Spark plug cap or high tension wiring damaged
- Spark plug cap not in good contact
- Spark plug incorrect
- IC igniter damaged
- Pickup coil damaged
- Ignition coil damaged

#### Fuel/air mixture incorrect:

- Pilot screw(s) maladjusted
- Pilot jet, or air passage clogged
- Air bleed pipe bleed holes clogged
- Air cleaner clogged, poorly sealed, or missing
- Air cleaner poorly sealed
- Starter plunger stuck open
- Fuel level too high or too low
- Fuel tank air vent obstructed
- Carburetor holders loose
- Carburetor linkage mechanism loose

#### Compression low:

- Spark plug loose
- Cylinder head not sufficiently tightened down
- No valve clearance
- Cylinder, piston worn
- Piston rings bad (worn, weak, broken or sticking)
- Piston ring/land clearance excessive
- Cylinder head gasket damaged
- Cylinder head warped
- Valve spring broken or weak
- Valve not seating properly (valve bent, worn, or carbon accumulation on the seating surface)

#### Other:

- Low speed ignition timing incorrect
- Carburetors not synchronizing
- Vacuum pistons don't slide smoothly
- Engine oil viscosity too high
- Brakes dragging
- Air suction valve damaged
- Vacuum switch valve damaged

### Poor Running or No Power at High Speed:

#### Firing incorrect:

- Spark plug dirty, defective, or maladjusted
- Spark plug cap or high tension wiring damaged

Spark plug cap not in good contact  
 Spark plug incorrect  
 IC igniter damaged  
 Pickup coil damaged  
 Ignition coil damaged  
 High speed ignition timing incorrect

**Fuel/air mixture incorrect:**

Main jet clogged or wrong size  
 Jet needle or needle jet worn  
 Jet needle clip in wrong position  
 Fuel level too high or too low  
 Air bleed pipe bleed hole clogged  
 Air cleaner clogged, poorly sealed, or missing  
 Air cleaner duct poorly sealed  
 Starter plunger stuck open  
 Water or foreign matter in fuel  
 Carburetor holders loose  
 Fuel tank air vent obstructed  
 Fuel tap clogged  
 Fuel line clogged

**Compression low:**

Spark plug loose  
 Cylinder head not sufficiently tightened down  
 No valve clearance  
 Cylinder, piston worn  
 Piston rings bad (worn, weak, broken, or sticking)  
 Piston ring/land clearance excessive  
 Cylinder head gasket damaged  
 Cylinder head warped  
 Valve spring broken or weak  
 Valve not seating properly (valve bent, worn, or carbon accumulation on the seating surface)

**Knocking:**

Ignition timing incorrect  
 Carbon built up in combustion chamber  
 Fuel poor quality or incorrect  
 Spark plug incorrect

**Miscellaneous:**

Butterfly valves won't fully open  
 Vacuum pistons don't slide smoothly  
 Brakes dragging  
 Clutch slipping  
 Overheating  
 Engine oil level too high  
 Engine oil viscosity too high  
 Air suction valve damaged  
 Vacuum switch valve damaged

**Overheating:**

**Firing incorrect:**

Spark plug dirty, damaged, or maladjusted  
 Spark plug incorrect  
 Ignition timing incorrect

**Fuel/air mixture incorrect:**

Main jet clogged  
 Fuel level too low  
 Carburetor holders loose  
 Air cleaner poorly sealed, or missing  
 Air cleaner duct poorly sealed

**Compression high:**

Carbon built up in combustion chamber

**Engine load faulty:**

Clutch slipping  
 Engine oil level too high  
 Engine oil viscosity too high  
 Brakes dragging

**Lubrication inadequate**

Engine oil level too low  
 Engine oil poor quality or incorrect

**Clutch Operation Faulty:**

**Clutch slipping:**

No clutch lever play  
 Friction plates worn or warped  
 Steel plates worn or warped  
 Clutch springs broken or weak  
 Clutch release maladjusted  
 Clutch inner cable catching  
 Clutch release mechanism damaged  
 Clutch hub or housing unevenly worn

**Clutch not disengaging properly:**

Clutch lever play excessive  
 Clutch plates warped or too rough  
 Clutch spring tension uneven  
 Engine oil deteriorated  
 Engine oil viscosity too high  
 Engine oil level too high  
 Clutch housing frozen on drive shaft  
 Clutch release mechanism damaged  
 Loose clutch hub nut

**Gear Shifting Faulty:**

**Doesn't go into gear; shift pedal doesn't return:**

Clutch not disengaging  
 Shift fork(s) bent or seized  
 Gear(s) stuck on the shaft  
 Shift drum detent arm binding  
 Shift pedal return spring weak or broken  
 Shift lever broken  
 External shift mechanism pawl broken  
 Shift return spring pin loose  
 Pawl spring broken

**Jumps out of gear:**

Shift fork(s) worn  
 Gear groove(s) worn  
 Gear dogs, dog holes, and/or recesses worn  
 Shift drum groove(s) worn  
 Shift drum set lever spring weak or broken  
 Shift fork pin(s) worn  
 Drive shaft, output shaft, and/or gear splines worn

**Overshifts:**

Shift drum set lever spring weak or broken  
 Pawl spring weak

**Abnormal Engine Noise:**

**Knocking:**

Ignition timing incorrect  
 Carbon built up in combustion chamber

Fuel poor quality or incorrect  
Spark plug incorrect

**Piston slap:**

Cylinder/piston clearance excessive  
Cylinder, piston worn  
Connecting rod bent  
Piston pin, piston holes worn

**Valve noise:**

Valve clearance incorrect  
Valve spring broken or weak  
Camshaft bearings worn  
Valve lifter worn

**Other noise:**

Connecting rod small end clearance excessive  
Connecting rod big end clearance excessive  
Piston ring(s) worn, broken, or stuck  
Piston seizure damage  
Cylinder head gasket leaking  
Exhaust pipe leaking at cylinder head connection  
Crankshaft runout excessive  
Engine mounts loose  
Crankshaft bearings worn  
Camshaft chain tensioner damaged  
Camshaft chain, sprocket, guides worn  
Loose alternator rotor  
Air suction valve damaged  
Vacuum switch valve damaged

**Abnormal Drive Train Noise:****Clutch noise:**

Clutch housing/friction plate clearance excessive  
Weak or damaged shock damper springs  
Primary reduction gear damaged

**Transmission noise**

Bearings worn  
Transmission gears worn or chipped  
Metal chips jammed in gear teeth  
Engine oil insufficient

**Drive chain noise:**

Drive chain adjusted improperly  
Chain worn  
Rear and/or engine sprocket(s) worn  
Chain lubrication insufficient  
Rear wheel misaligned

**Abnormal Frame Noise:****Front fork noise:**

Oil insufficient or too thin  
Spring weak or broken

**Rear shock absorber noise:**

Shock absorber damaged

**Disc brake noise:**

Pad installed incorrectly  
Pad surface glazed  
Disc warped

**Other noise:**

Brackets, nut, bolts, etc. not properly mounted  
or tightened

**Oil Pressure Indicator Light Goes On:**

Engine oil pump damaged  
Engine oil screen clogged  
Engine oil level too low  
Engine oil viscosity too low  
Camshaft bearings worn  
Crankshaft bearings worn  
Oil pressure switch damaged  
Wiring damaged

**Exhaust Smokes Excessively:****White smoke:**

Piston oil ring worn  
Cylinder worn  
Valve oil seal damage  
Valve guide worn  
Cylinder head gaskets are damaged  
Engine oil level too high

**Black smoke:**

Air cleaner clogged  
Main jet too large or fallen off  
Starter plunger stuck open  
Fuel level too high

**Brown smoke:**

Main jet too small  
Fuel level too low  
Air cleaner ducts loose  
Air cleaner poorly sealed or missing

**Handling and/or Stability Unsatisfactory:****Handlebar hard to turn:**

Steering stem locknut too tight  
Steering bearing worn or damaged  
Steering bearing lubrication inadequate  
Steering stem bent  
Tire air pressure too low

**Handlebar shakes or excessively vibrates:**

Tire(s) worn  
Swing arm needle bearing worn  
Rim(s) warped, or not balanced  
Spokes loose  
Wheel bearing(s) worn  
Handlebar clamps loose  
Steering stem head bolt and/or clamp bolt loose

**Handlebar pulls to one side:**

Frame bent  
Wheel misalignment  
Swing arm bent or twisted  
Steering stem bent  
Front fork bent  
Right/left front fork unbalanced (oil level, air pressure, spring tension)  
Right/left rear shock absorbers unbalanced (spring and damper force)

**Shock absorption unsatisfactory:**

Too hard:  
Front fork oil excessive  
Front fork oil viscosity too high  
Front fork air pressure too high

- Tire air pressure too high
- Rear shock absorber maladjusted
- Front fork bent
- Too soft:
- Front fork oil insufficient and/or leaking
- Front fork oil viscosity too low
- Front fork air pressure too low
- Front fork, rear shock absorber spring(s) weak
- Rear shock absorber oil leaking

**Brakes Don't Hold:**

- Air in the brake line
- Pad or disc worn
- Brake fluid leak
- Disc warped
- Contaminated pads
- Brake fluid deteriorated
- Primary or secondary cup damaged
- Master cylinder scratched inside

**Battery Discharged:**

- Battery fault (e.g., plates sulphated, shorted through sedimentation, electrolyte level too low)
- Battery leads making poor contact
- Load excessive (e.g., bulb of excessive wattage)
- Regulator/rectifier damaged
- Ignition switch damaged
- Regulator/rectifier damaged
- Wiring faulty
- Alternator rotor damaged

**Battery Overcharged:**

- Regulator/rectifier damaged

Prefixes for Units	Symbol	Value
micro	μ	0.000001
milli	m	0.001
centi	c	0.01
Kilo	k	1000
Mega	M	1,000,000

**Units of Length**

km	x	0.8214	mi
m	x	3.281	ft
mm	x	0.03937	in
mi	x	1.609	km
ft	x	0.3048	m
in	x	25.4	mm

**Units of Mass**

kg	x	2.205	lb
g	x	0.03527	oz
lb	x	0.4536	kg
oz	x	28.35	g

**Units of Torque**

kg-m	x	7.233	ft-lbs
kg-m	x	88.80	in-lbs
ft-lbs	x	0.1383	kg-m
in-lbs	x	0.01182	kg-m

**Units of Temperature**



**UNIT CONVERSION TABLE**

**Prefixes for Units**

Prefix	Symbol	Power
mega	M	x 1,000,000
kilo	k	x 1,000
centi	c	x 0.01
milli	m	x 0.001
micro	μ	x 0.000001

**Units of Length**

km	x	0.6214	=	mile
m	x	3.281	=	ft
mm	x	0.03937	=	in
mile	x	1.609	=	km
ft	x	0.3048	=	m
in	x	25.4	=	mm

**Units of Mass**

kg	x	2.205	=	lbs
g	x	0.03527	=	oz
lb	x	0.4536	=	kg
oz	x	28.35	=	g

**Units of Torque**

kg-m	x	7.233	=	ft-lbs
kg-m	x	86.80	=	in-lbs
ft-lbs	x	0.1383	=	kg-m
in-lbs	x	0.01152	=	kg-m

**Units of Temperature**

$$\frac{9 (^\circ\text{C} + 40)}{5} - 40 = ^\circ\text{F}$$

$$\frac{5 (^\circ\text{F} + 40)}{9} - 40 = ^\circ\text{C}$$

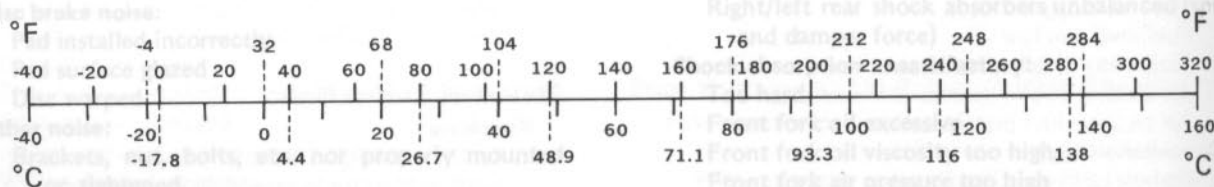

**Units of Volume**

liter	x	0.2642	=	gal (US)
liter	x	0.2200	=	gal (imp)
liter	x	1.057	=	qt (US)
liter	x	0.8799	=	qt (imp)
liter	x	2.113	=	pint (US)
liter	x	1.816	=	pint (imp)
cc	x	0.03381	=	oz (US)
cc	x	0.02816	=	oz (imp)
cc	x	0.06102	=	cu in
gal (US)	x	3.785	=	liter
gal (imp)	x	4.546	=	liter
qt (US)	x	0.9464	=	liter
qt (imp)	x	1.137	=	liter
pint (US)	x	0.4732	=	liter
pint (imp)	x	0.5506	=	liter
oz (US)	x	29.57	=	cc
oz (imp)	x	35.51	=	cc
cu in	x	16.39	=	cc

**Units of Power**

kW	x	1.341	=	hp
hp	x	0.7457	=	kW

**Units of Pressure**

kg/cm <sup>2</sup>	x	98.07	=	kPa
kg/cm <sup>2</sup>	x	14.22	=	psi
kPa	x	0.01020	=	kg/cm <sup>2</sup>
kPa	x	0.1450	=	psi
psi	x	0.07031	=	kg/cm <sup>2</sup>
psi	x	6.895	=	kPa



# Supplement - KZ1100-B1

There are a number of important precautions that must be observed when servicing the Kawasaki electronic fuel injection system wiring (especially high tension leads of the ignition system). This is to prevent the control unit from malfunctioning due to external electrical noises.

This "Supplement - KZ1100-B1" chapter is designed to be used in conjunction with the front part of this manual (up to the end of the "Appendix" chapter). The maintenance and repair procedures described in this chapter are only those that are unique to the KZ/Z1100-B1. Complete and proper servicing of the KZ/Z1100-B1 therefore requires mechanics to read both this chapter and the text in front of this chapter.

**NOTE:** Unless otherwise noted, procedures for the KZ/Z1100-B1 are the same as for the 1981 KZ/Z1000J.

**NOTE:** 1. Whenever electrical connections are to be disconnected, first turn off the ignition switch, disconnect the white/red lead which connects the Kawasaki fuel injection system to the battery positive (+) side under the seat, and then disconnect the required connections.

## Table of Contents

GENERAL INFORMATION .....	9-2
SCHEDULED MAINTENANCE .....	9-13
NON-SCHEDULED MAINTENANCE .....	9-18
DISASSEMBLY .....	9-32

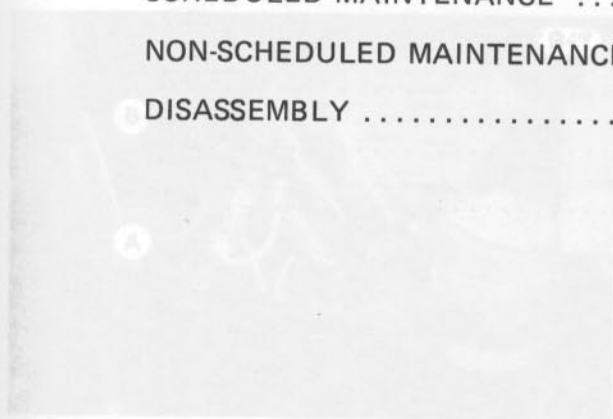

A. White/Red Lead    B. Battery Positive (+) Lead.

2. Conversely, make sure that all electrical connections are firmly reconnected before starting the engine. Be sure to connect the two fuel injection system leads (black/green and black/yellow) to the battery negative terminal.

3. The Kawasaki electronic fuel injection system is designed to be used with a 12-volt battery as its power source. Do not use anything other than a 12-volt battery as a power source.

**NOTE:** 1. Do not directly connect a 12-volt battery to a fuel injector. Insert a resistor, which has a resistance of 5 - 7 Ω, in series between the battery and the injector, or use a 3-volt dry battery.

4. Always disconnect the battery positive and negative leads from the terminals, and remove the battery from the motorcycle for charging. This is to prevent the control unit from being damaged by excessive peak voltage.

5. Avoid spraying water with any great force on the electric components, connectors, leads, and wiring harness of the electronic fuel injection system.

**NOTE:** 1. Locate the antenna as far as possible from the control unit. The antenna can be reduced by grounding the control unit box to the motorcycle.

8. Do not start the engine while the 7-pin connector on the air flow meter is disconnected. This could damage the control unit.

1. Do not touch the fuel pump. The inside of the pump is completely dry. This is to prevent the pump from being damaged by friction surface.

2. Blow the fuel lines with compressed air before the fuel line is connected.

3. Any hose used in the fuel system must be replaced if it is damaged or worn.

**NOTE:** 1. Install the clamp in the position shown in the diagram.

4. To prevent corrosion and deposits in the fuel system, do not add any additives to the fuel.

### Air System:

1. In order to maintain the correct fuel/air mixture, there must be no air leaks in the system.

**NOTE:** 1. Be sure to install the oil filter cap securely after adding engine oil.

Supplement - KZ1100-B1

Prefixes for Units

centi	c	$\times 100$
milli	m	$\times 1000$
micro	$\mu$	$\times 1000000$

# General Information

## Table of Contents

Units of Length

km  
m  
mm  
mile  
ft  
in

SAFETY INSTRUCTIONS ..... 9-3

MODEL IDENTIFICATION ..... 9-4

SPECIFICATIONS ..... 9-5

LOCATION OF PARTS ..... 9-7

SERVICE DATA ..... 9-8

SPECIAL TOOLS ..... 9-9

Units of Mass

kg  
g  
lb  
oz

WIRING DIAGRAMS ..... 9-10

Units of Power

kW  
hp

Units of Pressure

kg/cm<sup>2</sup>  
kg/cm<sup>2</sup>  
kPa  
kPa  
psi  
psi

Units of Torque

kg-m  
kg-m  
ft-lbs  
in-lbs

Units of Temperature

$$\frac{9}{5} (^{\circ}\text{C} + 40) - 40 = ^{\circ}\text{F}$$

$$\frac{5}{9} (^{\circ}\text{F} + 40) - 40 = ^{\circ}\text{C}$$



## SAFETY INSTRUCTIONS

There are a number of important precautions that must be observed when servicing the Kawasaki electronic fuel injection system. Failure to observe these precautions can result in serious system damage. Learn and observe all the rules listed below.

### Electric System:

1. Do not disconnect the battery leads or any other electrical connections when the ignition switch is on, or while the engine is running. This is to prevent control unit damage.

**NOTE:** 1. Whenever electrical connections are to be disconnected, first turn off the **ignition switch**, disconnect the **white/red lead** which connects the Kawasaki fuel injection system harness to the battery positive (+) side under the left side cover, and then disconnect the required connections. There are two other white/red leads (the fuse and regulator/rectifier leads) which are connected to the battery positive terminal, but these leads can be left connected.

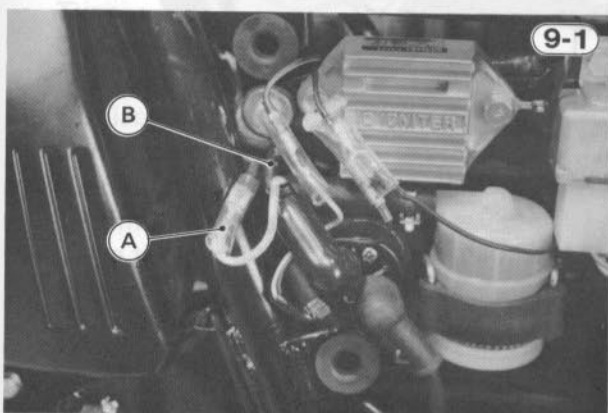

A. White/Red Lead      B. Battery Positive (+) Lead

2. Conversely, make sure that all electrical connections are firmly reconnected before starting the engine. Be sure to connect the two fuel injection system leads (black/green and black/yellow) to the battery negative terminal.
3. The Kawasaki electronic fuel injection system is designed to be used with a 12-volt battery as its power source. Do not use anything other than a 12-volt battery as a power source.

**NOTE:** 1. Do not directly connect a 12-volt battery to a fuel injector. Insert a resistor, which has a resistance of 5 – 7  $\Omega$ , in series between the battery and the injector, or use a 3-volt dry battery.

4. Always disconnect the battery positive and negative leads from the terminals, and remove the battery from the motorcycle for charging. This is to prevent the control unit from being damaged by excessive peak voltage.
5. Avoid spraying water with any great force on the electric components, connectors, leads, and wiring harness of the electronic fuel injection system.

6. Keep the electronic fuel injection system wiring harness at least 100 mm from all other system leads (especially high tension leads of the ignition system). This is to prevent the control unit from malfunctioning due to external electrical noises.

7. If a transceiver is installed on the motorcycle, make sure that the operation of the fuel injection system is not influenced by electric wave radiated from the antenna. Check operation of the system with the engine at idle.

**NOTE:** 1. Locate the antenna as far as possible from the control unit. The interference from radio waves can be reduced by grounding the control-unit box to the motorcycle.

8. Do not start the engine while the 7-pin connector on the air flow meter is disconnected. This could damage the control unit.

### Fuel System:

1. Do not operate the fuel pump if the inside of the pump is completely dry. This is to prevent the pump from running without lubricant at the friction surfaces.
2. Blow the fuel system clean with compressed air before removing the parts.
3. Any hose clamps on the high-pressure fuel line must be replaced with new ones once they are loosened.

**NOTE:** 1. Install the hose clamps in the position shown in Fig. 9-45, and securely tighten the clamp screws. Check the fuel system for leaks.

4. To prevent corrosion and deposits in the fuel system, do not add any antifreeze chemicals.

### Air System:

1. In order to maintain the correct fuel/air mixture, there must be no air leaks in the system.

**NOTE:** 1. Be sure to install the oil filler cap securely after adding engine oil.

(Continued on next page.)

### MODEL IDENTIFICATION

**KZ1100B:**

## General Information



### SAFETY INSTRUCTIONS

There are a number of important precautions that must be observed when servicing the Kawasaki electronic fuel injection system. Failure to observe these precautions will result in serious system damage. Learn and observe all the rules listed below.

**9-2**

#### Electric System:

1. Do not disconnect the battery leads or any other electrical connections when the ignition switch is turned on while the engine is running. This is to prevent control unit damage.

**NOTE:** Disconnect the battery leads when the engine is stopped.

**9-3**

#### Air System:

1. In order to maintain the correct fuel/air mixture, there must be no air leaks in the system.

**NOTE:** 1. Be sure to install the oil filter cap securely after adding engine oil.

2. To prevent corrosion and deposits in the fuel system, do not add any antifreeze chemicals.

3. Check the fuel system for leaks.

4. To prevent corrosion and deposits in the fuel system, do not add any antifreeze chemicals.

## SPECIFICATIONS

### KZ/Z1100B Specifications:

Items	KZ/Z1100B
<b>Dimensions:</b>	
Overall length	2,265 mm, (U) 2,240 mm
Overall width	820 mm
Overall height	1,145 mm
Wheelbase	1,540 mm
Road clearance	145 mm
Seat height	805 mm
Dry weight	237.5 kg
Fuel tank capacity	21.4 liters
<b>Performance:</b>	
Climbing ability	30°
Braking distance	12.5 m from 50 kph
Minimum turning radius	2.6 m
<b>Engine:</b>	
Type	4-stroke, DOHC, 4-cylinder
Cooling system	Air cooled
Bore and stroke	72.5 x 66.0 mm
Displacement	1,089 cc
Compression ratio	8.9
Maximum horsepower	108HP @8,500 rpm, (G) 100HP @8,000 rpm
Maximum torque	9.8 kg-m @7,000 rpm, (G) 9.3 kg-m @7,000 rpm
Valve timing:	
Inlet	Open 35° BTDC
	Close 65° ABDC
	Dulation 280°
Exhaust	Open 68° BBDC
	Close 32° ATDC
	Duration 280°
Carburetion system	Electronic fuel injection
Cylinder numbering method	Left to right, 1-2-3-4
Firing order	1-2-4-3
Lubrication system	Forced lubrication (Wet sump with oil cooler)
Engine oil:	
Grade	SE class
Viscosity	SAE 10W40, 10W50, 20W40, or 20W50
Capacity	
Engine	3.7 liters
Oil cooler and hoses	0.2 liters
Starting system	Electric starter
Ignition system	Battery and coil (Transistorized)
Timing advance	Mechanically advanced
Ignition timing	From 10° BTDC @1,000 rpm to 40° BTDC @3,400 rpm
Spark plugs	NGK BR8ES or ND W24ES-U, (U) NGK B8ES or ND W24ES-U

(U): US model (G): West German, Swiss, and Swedish models

Specifications subject to change without notice, and may not apply to every country.

(Continued on next page.)

## KZ/Z1100B Specifications (Cont.):

Items	KZ/Z1100B
<b>Drive Train:</b>	
Primary reduction system:	
Type	Gear
Reduction ratio	1.732 (97/56)
Clutch type	Wet multi disc
Transmission:	
Type	5-speed, constant mesh, return shift
Gear ratios	1st 2.642 (37/14)
	2nd 1.833 (33/18)
	3rd 1.428 (30/21)
	4th 1.173 (27/23)
	5th 1.040 (26/25)
Final drive system:	
Type	Chain drive
Reduction ratio	2.733 (41/15)
Overall drive ratio	4.923 @Top gear
<b>Frame:</b>	
Type	Tubular, double cradle
Castor (rake angle)	29°
Trail	120 mm
Front tire:	
Type	Tubeless
Size	3.25V-19 4PR
Rear tire:	
Type	Tubeless
Size	4.25V-18 4PR
Front suspension:	
Type	Telescopic fork (Pneumatic)
Wheel travel	145 mm
Rear suspension:	
Type	Swing arm
Wheel travel	104 mm
Brake type:	
Front	Dual disc brake
Rear	Single disc brake
<b>Electrical Equipment:</b>	
Alternator:	
Type	Three-phase AC
Rated output	20 amp. @8,000 rpm, 14V
Voltage regulator	Short-circuit type
Battery	12V 16AH
Headlight:	
Type	Sem-sealed
Bulb	12V 60/55W (Quartz-halogen)
Tail/brake light	12V 5/21W x 2, Ⓢ Ⓞ 12V 8/27W x 2

Ⓢ : US model      Ⓞ : Canadian model

Specifications subject to change without notice, and may not apply to every country.

**LOCATION OF PARTS**

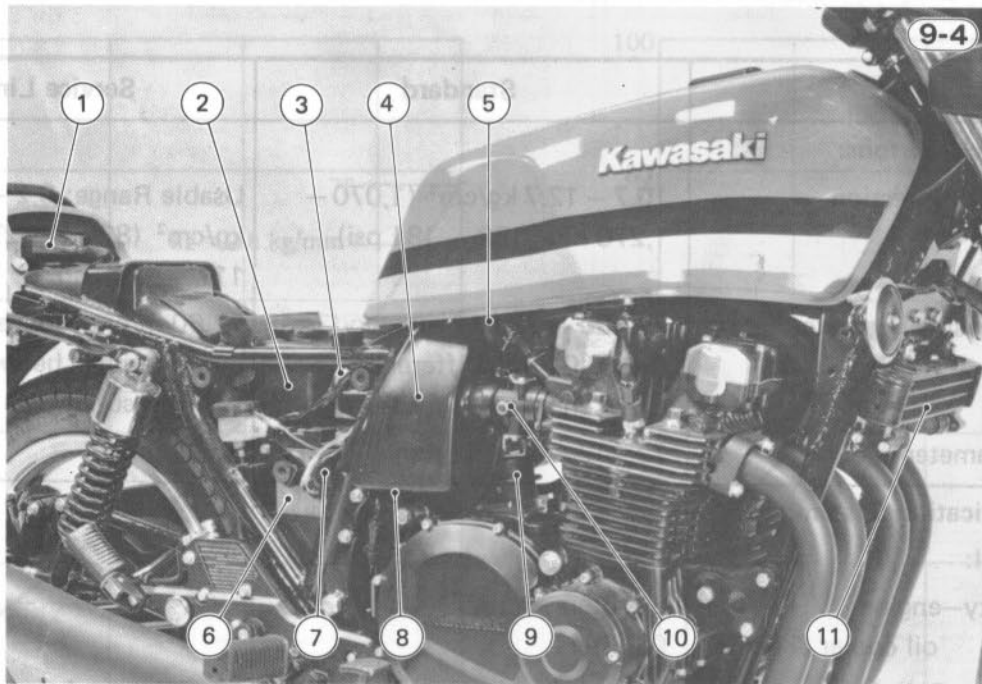

- |                   |                 |  |                             |
|-------------------|-----------------|--|-----------------------------|
| 1. Control Unit   | 5. Check Valve  | 8. Regulator/Rectifier<br>(front side of<br>battery housing) | 9. Pressure Regulator       |
| 2. Air Cleaner    | 6. Battery      |  | 10. Throttle Valve Assembly |
| 3. Air Flow Meter | 7. Hazard Relay |  | 11. Oil Cooler              |
| 4. Surge Tank     |                 |  |                             |

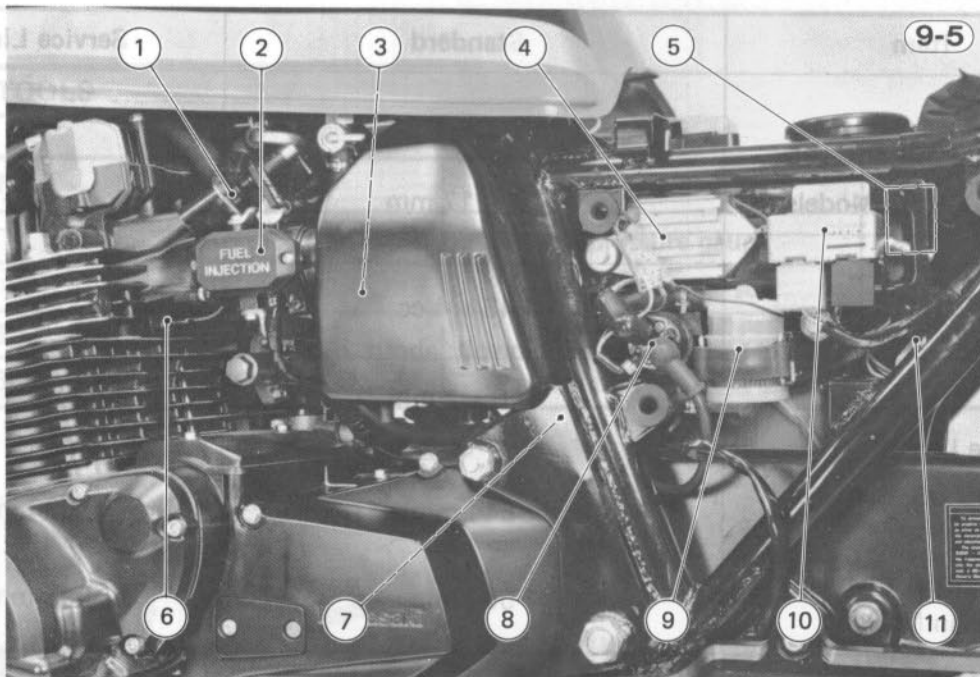

- |   |  |  |   |
|---|--|--|---|
| 1. Fuel Injectors                                     | 5. Reserve Lighting Device<br>(US model) | 7. Fuel Pump (under<br>air flow meter) | 10. Relay   |
| 2. Throttle Valve Switch                              | 6. Engine Temperature<br>Sensor          | 8. Starter Relay                       | 11. Turn Signal Relay<br>(under air cleaner<br>housing) |
| 3. Idle Switch (bottom of<br>throttle valve assembly) |  | 9. Fuel Filter                         |   |
| 4. IC Igniter   |  |  |   |

**SERVICE DATA**
**Engine:**

Item	Standard	Service Limit
<b>Cylinder Block, Pistons:</b>		
Cylinder Compression	10.7 – 12.7 kg/cm <sup>2</sup> (1,070 – 1,270 kPa, 152 – 181 psi)	Usable Range: 8.2 – 12.7 kg/cm <sup>2</sup> (820 – 1,270 kPa, 117 – 181 psi)
Cylinder Inside Diameter	72.500 – 72.512 mm, and less than 0.01 mm difference between any two measurements	72.60 mm, or more than 0.05 mm difference between any two measurements
Piston Diameter	72.442 – 72.457 mm	72.30 mm
<b>Engine Lubrication System:</b>		
Engine Oil:		
Capacity—engine	3.7 liters	---
oil cooler & hoses	0.2 liters	---
Oil Pressure Relief Valve Open	4.4 – 6.0 kg/cm <sup>2</sup> (440 – 600 kPa, 63 – 85 psi)	---

**Chassis:**

Item	Standard	Service Limit
<b>Brakes:</b>		
Brake Pedal Position: KZ/Z1100B All Models	13 – 17 mm	---
<b>Front Fork:</b>		
Oil Capacity	343 ± 4 cc (When changing oil: about 290 cc)	---
Oil Level	120 ± 2 mm	---
Spring Free Length		
KZ1100B US, Canadian Models	544 mm	533 mm
Z1100B other than US, Canadian Models	554 mm	543 mm



Front Fork Spring Force (per one fork leg unit)

9-6

(1) KZ/Z1100-B1 (US and Canadian Models)

(2) Z1100-B1 (European and General Export Models)

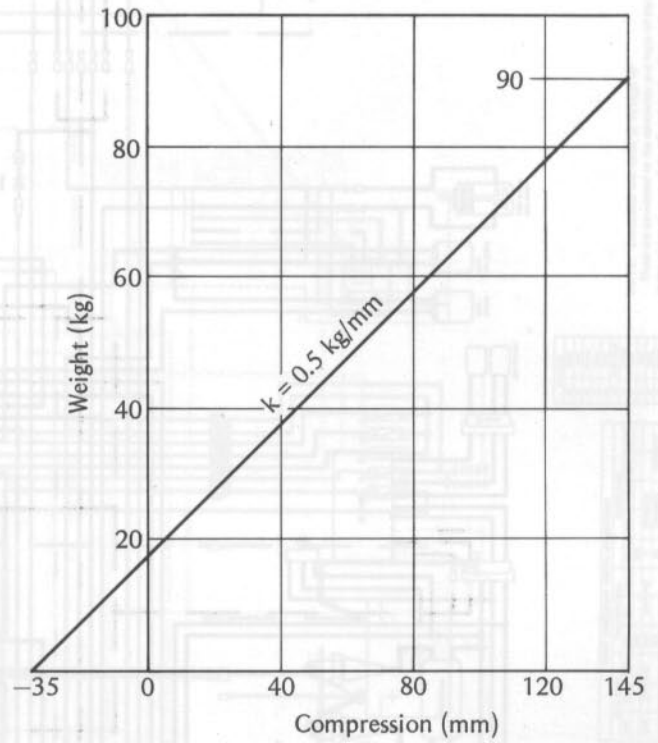
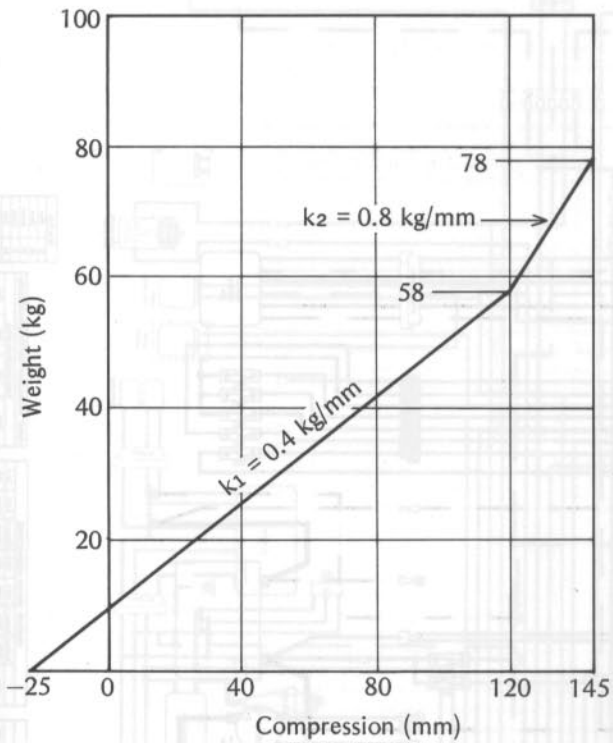

SPECIAL TOOLS

Ref. No.	Part No.	Description	Quantity
5	57001-125	Oil pressure gauge	1
6	57001-127	Vacuum gauge set	1 set
26	57001-983	Hand tester	1
56	57001-1089	Adapter	1

9-7



**KZ1100-B1 Wiring Diagram  
(US, Canadian Models)**

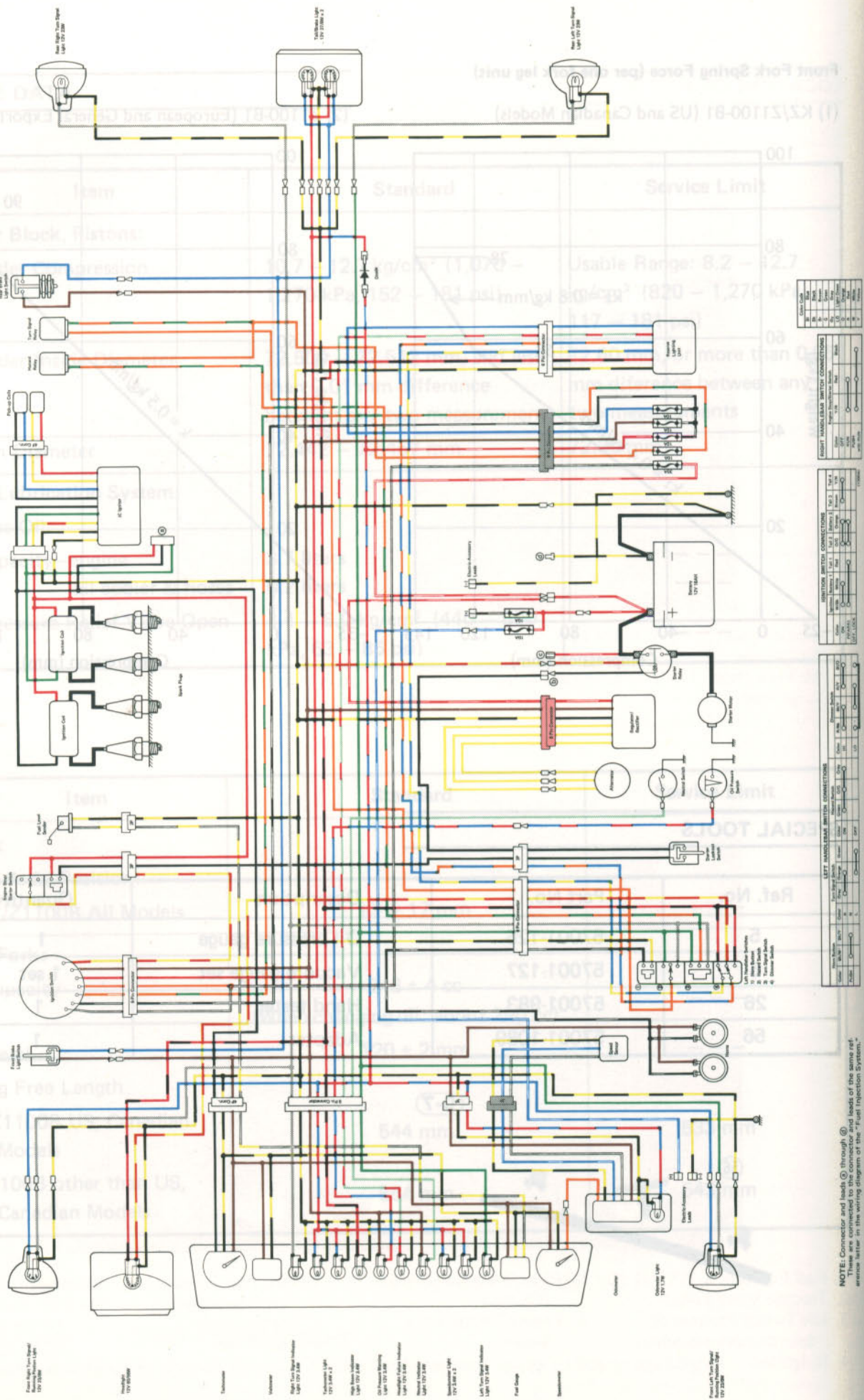

NOTE: Connector and leads ② through ④ lack of the wires refer to the connector and leads in the wiring diagram of the Fuel Injection System.



Electronic Fuel Injection System Wiring Diagram

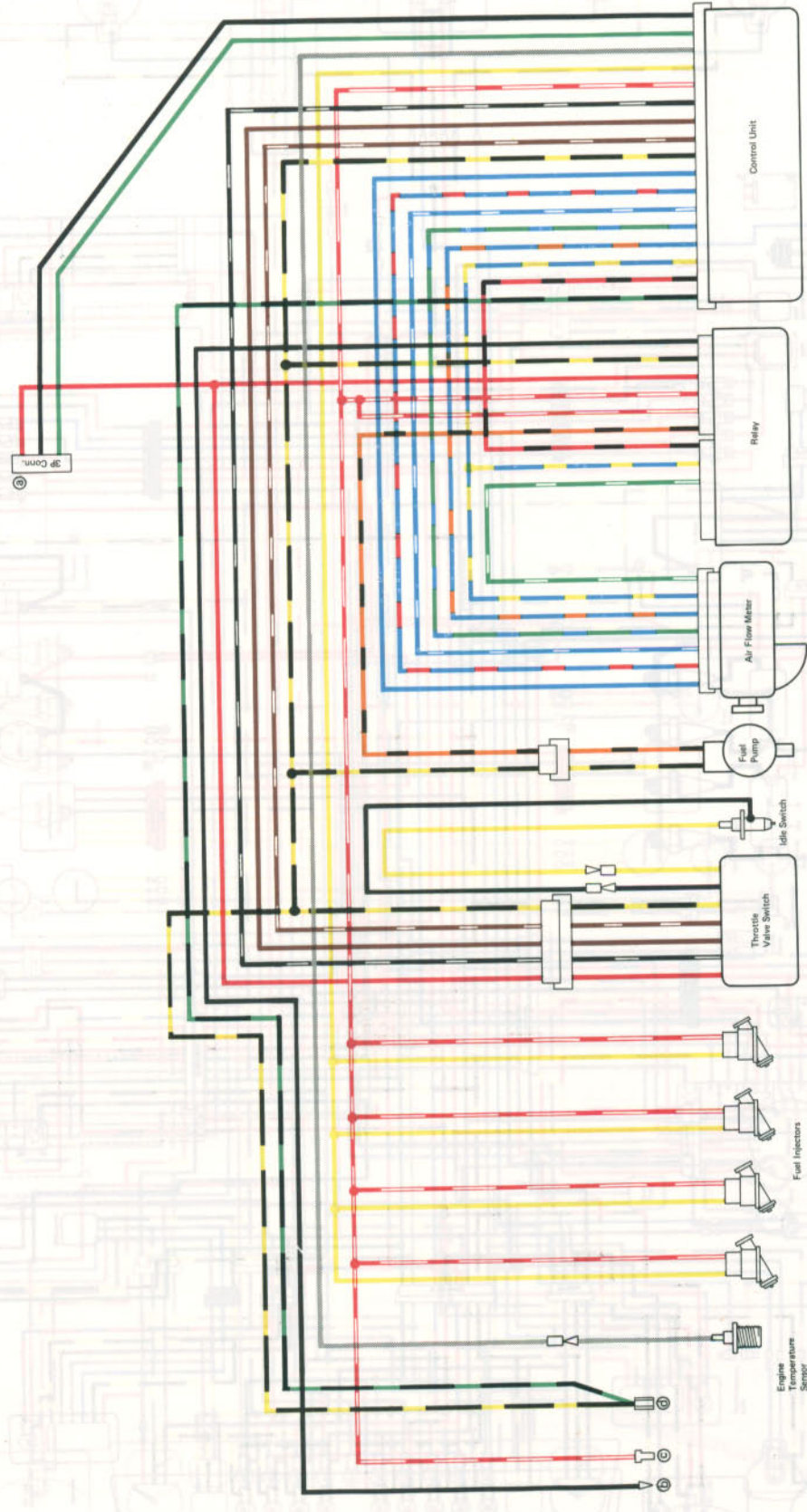

NOTE: Connector and leads ① through ④ These are connected to the connector and leads of the same reference letter in the wiring diagram of the "KZ21100.B1."

KZ21100-B1 Wiring Diagram (US, Canada, Mexico)

(Emobesu Waprep) SJ 100-B1 Airflow Diagram

# Scheduled Maintenance

## Table of Contents

PERIODIC MAINTENANCE CHART .....	9-14
ENGINE OIL, OIL FILTER .....	9-15
AIR CLEANER .....	9-15
IDLE SPEED .....	9-16
FUEL SYSTEM .....	9-17

**CAUTION**

See "SAFETY INSTRUCTIONS" on Pg. 9-3 before servicing the Kawasaki electronic fuel injection system.

Item	Frequency	10,000 km	20,000 km	30,000 km	40,000 km	50,000 km	60,000 km	70,000 km	80,000 km	90,000 km	100,000 km	Year
Oil filter	Change											Year
General lubrication	Check											Year
Engine oil	Change											Year
Air cleaner element	Replace											Year
Air cleaner element	Clean											Year
Air suction valve	Check											Year
Valve clearance	Check											Year
Spark plug	Clean and gap											Year
Nut, bolt, fastener	Check											Year
Front fork	Clean											Year
Drive chain wear	Check											Year

with a new one if it is damaged. Tighten the cap securely. An air cooler is equipped in the engine lubrication system. An oil cooler is equipped in the engine lubrication system. Additional 0.2 liter of oil will be required for the oil cooler and hoses if the oil is completely drained.

The air cleaner should be cleaned frequently. For higher engine performance, clean the air filter through rain or on muddy roads. The element should be cleaned immediately. The element should be replaced if it is damaged.

## PERIODIC MAINTENANCE CHART

The maintenance and adjustments for the KZ/Z1100B must be done in accordance with this chart to keep the motorcycle in good running condition. **The initial maintenance is vitally important and must not be neglected.**

OPERATION	FREQUENCY	ODOMETER READING *							See Page
		800 km	5,000 km	10,000 km	15,000 km	20,000 km	25,000 km	30,000 km	
Battery electrolyte level – check †	Every month	•	•	•	•	•	•	•	2-24
Brake wear – check †			•	•	•	•	•	•	2-15
Brake fluid level – check †	month	•	•	•	•	•	•	•	2-15
Brake fluid – change	year			•		•		•	2-16
Brake light switch – check †		•	•	•	•	•	•	•	2-18
Clutch – adjust		•	•	•	•	•	•	•	2-12
Idle speed – check †		•	•	•	•	•	•	•	2-10
Throttle grip – check †		•	•	•	•	•	•	•	2-10
Steering play – check †		•	•	•	•	•	•	•	2-18
Fuel filter – replace			•		•		•		9-17
Drive chain wear – check †			•	•	•	•	•	•	2-14
Front fork – clean			•	•	•	•	•	•	2-20
Nuts, bolts, fasteners – check †		•		•		•		•	2-28
Spark plug – clean and gap †		•	•	•	•	•	•	•	2-5
Valve clearance – check †		•	•	•	•	•	•	•	2-5
Air suction valve – check † (US Model)			•	•	•	•	•	•	2-9
Air cleaner element – clean			•		•		•		9-15
Air cleaner element – replace	5 cleanings			•		•		•	9-15
Tire tread wear – check †			•	•	•	•	•	•	2-21
Engine oil – change	year	•	•	•	•	•	•	•	9-15
Oil filter – replace		•		•		•		•	9-15
General lubrication – perform			•	•	•	•	•	•	2-25

\* For higher odometer readings, repeat at the frequency interval established here.

† Replace, add, adjust, or torque if necessary.

## PERIODIC MAINTENANCE CHART (Cont.)

OPERATION	FREQUENCY	ODOMETER READING *							See Page
		800 km	5,000 km	10,000 km	15,000 km	20,000 km	25,000 km	30,000 km	
Front fork oil – change	Every			•		•		•	9-8
Timing advancer – lubricate				•		•		•	2-5
Swing arm – lubricate				•		•		•	2-23
Wheel bearing – lubricate	2 years					•			2-22
Steering stem bearings – lubricate	2 years					•			2-20
Master cylinder cup and dust seal – replace	2 years								2-17
Caliper piston seal and dust seal – replace	2 years								2-17
Brake hose – replace	4 years								2-17
High-pressure fuel hose – replace	2 years								9-17
Low-pressure fuel hose – replace	4 years								9-17
Drive chain – lubricate	Every 300 km								2-15
Drive chain slack – check †	Every 800 km								2-13

\* For higher odometer readings, repeat at the frequency interval established here.

† Replace, add, adjust, or torque if necessary.

## ENGINE OIL, OIL FILTER

Refer to Pg. 2-4, noting the following:

- When replacing the engine oil, check the O-ring of the filler cap for damage and deterioration, and replace it with a new one if it is damaged. Tighten the cap securely. An air leak can cause the fuel injection system to malfunction.
- An oil cooler is equipped in the engine lubrication system. Additional oil of 0.2 liter will be required for the oil cooler and hoses if the oil is completely drained.

## AIR CLEANER

A clogged air cleaner restricts the engine's air intake, increasing fuel consumption, reducing engine power, and causing spark plug fouling.

The air cleaner element must be cleaned and replaced in accordance with the Periodic Maintenance Chart. In dusty areas, the element should be cleaned more frequently than the recommended interval. After riding through rain or on muddy roads, the element should be cleaned immediately. The element should be replaced if it is damaged.

**Cleaning**

- Remove the seat.
- Remove the air cleaner cap, and pull out the air cleaner element.



A. Element

- Separate the element into the sponge filter and the wire frame.
- Check the filter and sponge gaskets of the element for damage.
- ★ If the gasket comes loose, stick it back on with an adhesive sealant.
- ★ If the gasket or the filter is damaged, replace the element with a new one.
- Clean the element in a bath of a high flash-point solvent, and then squeeze it dry.

**WARNING** 1. Clean the element in a well-ventilated area, and take ample care that there are no sparks or flame anywhere near the working area.

2. Because of the danger of highly flammable liquids, do not use gasoline or a low flash-point solvent to clean the element.

- After cleaning, saturate the sponge filter with SE class SAE 30 oil, squeeze out the excess, then wrap it in a clean rag and squeeze it dry as possible. Be careful not to tear the element.

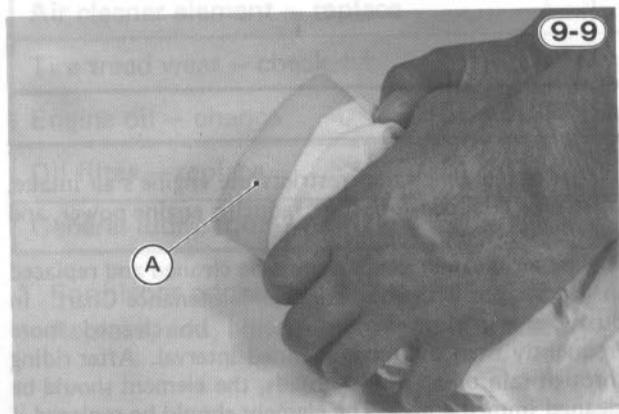

A. Sponge Filter

- Put the filter back on the wire frame, and install the element into the air cleaner housing.
- Install the air cleaner cap on the housing. Push the cap until you feel a click.
- Install the seat.

**Replacement**

Since repeated cleaning opens the pores of the filter, replace it according to the Periodic Maintenance Chart.

**IDLE SPEED**

Refer to Pg. 2-11, noting the following:

**NOTE:** In case of unstable or rough engine idling, check the following regarding the electronic fuel injection system as well as the engine itself.

1. Electric System: Make sure that (a) all connectors in the circuit are clean and tight, (b) the electronic fuel injection system harness is at least 100 mm away from the wiring of the ignition system, (c) radio waves from a transceiver are not affecting the electronic system.
2. Fuel System: Make sure that all fuel and vacuum hoses are correctly routed and connected.
3. Air System: Make sure that (a) there is no air leak at the engine oil filler cap and the breather hose connections, (b) there is no air leak where air flow meter is connected to the engine, (c) the throttle valves are synchronized.

**CAUTION**

The idle switch and the idle adjusting screw is one piece, so observe the following rule.

1. Check to see if the switch lead is not badly twisted. If it is; disconnect the lead connection to release the twist, and reconnect the lead.

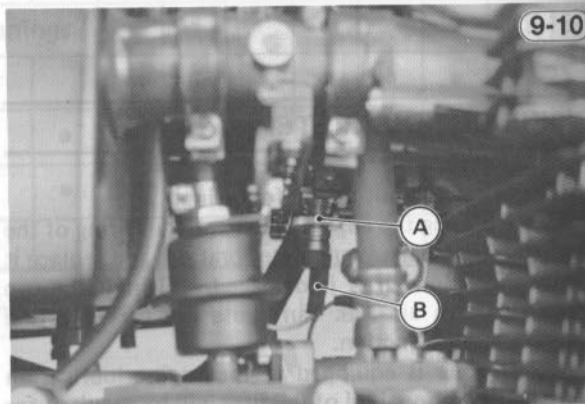
A. Idle Adjusting Screw and Idle Switch  
B. Switch Lead



**FUEL SYSTEM**

**Fuel Filter Replacement**

Replace the fuel filter in accordance with the Periodic Maintenance Chart. Refer to Pg. 9-35 for the procedure.

**Fuel Hose Replacement**

Replace the fuel hoses in accordance with the Periodic Maintenance Chart. Refer to Pg. 9-34 for instructions.

High-pressure hoses (See Fig. 9-29):

- Hose between fuel pump and fuel pipe.
- Hose between fuel distributing pipe and pressure regulator.

Low-pressure hoses:

- Hose between fuel tap and fuel filter
- Hose between fuel filter and fuel pump
- Hose between pressure regulator and check valve

Test procedure for the fuel gauge of the KZ/Z1000 ...  
 at the same time of the KZ/Z1000 with the following exception. See Pg. 5-31 through 5-33.

1. Fuel gauge ...
2. Measure the gauge internal resistance with one of



- |   |                            |                       |
|---|----------------------------|-----------------------|
| 1. Right Turn Indicator (Gray, Black/Yellow Leads)                                  | 5. Fuel Gauge (Lead 1)     | 11. Black Lead        |
| 2. US Model only: Headlight Failure Indicator (Light Green/Red, Black/Yellow Leads) | 6. Fuel Gauge (Lead 2)     | 12. Black/Yellow Lead |
| 3. High Beam Indicator (Red/Black, Black/Yellow Leads)                              | 7. Fuel Gauge (Lead 3)     | 13. Brown Lead        |
| 4. White/Yellow Lead  | 8. Fuel Gauge (Lead 4)     | 14. Brown Lead        |
|   | 9. Fuel Gauge (Lead 5)     | 15. Brown Lead        |
|   | 10. Fuel Gauge (Lead 6)    | 16. Brown Lead        |
|   | 11. Fuel Gauge (Lead 7)    | 17. Black/Yellow Lead |
|   | 12. Fuel Gauge (Lead 8)    | 18. Orange Lead       |
|   | 13. Fuel Gauge (Lead 9)    |                       |
|   | 14. Fuel Gauge (Lead 10)   |                       |
|   | 15. Fuel Gauge (Lead 11)   |                       |
|   | 16. Fuel Gauge (Lead 12)   |                       |
|   | 17. Fuel Gauge (Lead 13)   |                       |
|   | 18. Fuel Gauge (Lead 14)   |                       |
|   | 19. Fuel Gauge (Lead 15)   |                       |
|   | 20. Fuel Gauge (Lead 16)   |                       |
|   | 21. Fuel Gauge (Lead 17)   |                       |
|   | 22. Fuel Gauge (Lead 18)   |                       |
|   | 23. Fuel Gauge (Lead 19)   |                       |
|   | 24. Fuel Gauge (Lead 20)   |                       |
|   | 25. Fuel Gauge (Lead 21)   |                       |
|   | 26. Fuel Gauge (Lead 22)   |                       |
|   | 27. Fuel Gauge (Lead 23)   |                       |
|   | 28. Fuel Gauge (Lead 24)   |                       |
|   | 29. Fuel Gauge (Lead 25)   |                       |
|   | 30. Fuel Gauge (Lead 26)   |                       |
|   | 31. Fuel Gauge (Lead 27)   |                       |
|   | 32. Fuel Gauge (Lead 28)   |                       |
|   | 33. Fuel Gauge (Lead 29)   |                       |
|   | 34. Fuel Gauge (Lead 30)   |                       |
|   | 35. Fuel Gauge (Lead 31)   |                       |
|   | 36. Fuel Gauge (Lead 32)   |                       |
|   | 37. Fuel Gauge (Lead 33)   |                       |
|   | 38. Fuel Gauge (Lead 34)   |                       |
|   | 39. Fuel Gauge (Lead 35)   |                       |
|   | 40. Fuel Gauge (Lead 36)   |                       |
|   | 41. Fuel Gauge (Lead 37)   |                       |
|   | 42. Fuel Gauge (Lead 38)   |                       |
|   | 43. Fuel Gauge (Lead 39)   |                       |
|   | 44. Fuel Gauge (Lead 40)   |                       |
|   | 45. Fuel Gauge (Lead 41)   |                       |
|   | 46. Fuel Gauge (Lead 42)   |                       |
|   | 47. Fuel Gauge (Lead 43)   |                       |
|   | 48. Fuel Gauge (Lead 44)   |                       |
|   | 49. Fuel Gauge (Lead 45)   |                       |
|   | 50. Fuel Gauge (Lead 46)   |                       |
|   | 51. Fuel Gauge (Lead 47)   |                       |
|   | 52. Fuel Gauge (Lead 48)   |                       |
|   | 53. Fuel Gauge (Lead 49)   |                       |
|   | 54. Fuel Gauge (Lead 50)   |                       |
|   | 55. Fuel Gauge (Lead 51)   |                       |
|   | 56. Fuel Gauge (Lead 52)   |                       |
|   | 57. Fuel Gauge (Lead 53)   |                       |
|   | 58. Fuel Gauge (Lead 54)   |                       |
|   | 59. Fuel Gauge (Lead 55)   |                       |
|   | 60. Fuel Gauge (Lead 56)   |                       |
|   | 61. Fuel Gauge (Lead 57)   |                       |
|   | 62. Fuel Gauge (Lead 58)   |                       |
|   | 63. Fuel Gauge (Lead 59)   |                       |
|   | 64. Fuel Gauge (Lead 60)   |                       |
|   | 65. Fuel Gauge (Lead 61)   |                       |
|   | 66. Fuel Gauge (Lead 62)   |                       |
|   | 67. Fuel Gauge (Lead 63)   |                       |
|   | 68. Fuel Gauge (Lead 64)   |                       |
|   | 69. Fuel Gauge (Lead 65)   |                       |
|   | 70. Fuel Gauge (Lead 66)   |                       |
|   | 71. Fuel Gauge (Lead 67)   |                       |
|   | 72. Fuel Gauge (Lead 68)   |                       |
|   | 73. Fuel Gauge (Lead 69)   |                       |
|   | 74. Fuel Gauge (Lead 70)   |                       |
|   | 75. Fuel Gauge (Lead 71)   |                       |
|   | 76. Fuel Gauge (Lead 72)   |                       |
|   | 77. Fuel Gauge (Lead 73)   |                       |
|   | 78. Fuel Gauge (Lead 74)   |                       |
|   | 79. Fuel Gauge (Lead 75)   |                       |
|   | 80. Fuel Gauge (Lead 76)   |                       |
|   | 81. Fuel Gauge (Lead 77)   |                       |
|   | 82. Fuel Gauge (Lead 78)   |                       |
|   | 83. Fuel Gauge (Lead 79)   |                       |
|   | 84. Fuel Gauge (Lead 80)   |                       |
|   | 85. Fuel Gauge (Lead 81)   |                       |
|   | 86. Fuel Gauge (Lead 82)   |                       |
|   | 87. Fuel Gauge (Lead 83)   |                       |
|   | 88. Fuel Gauge (Lead 84)   |                       |
|   | 89. Fuel Gauge (Lead 85)   |                       |
|   | 90. Fuel Gauge (Lead 86)   |                       |
|   | 91. Fuel Gauge (Lead 87)   |                       |
|   | 92. Fuel Gauge (Lead 88)   |                       |
|   | 93. Fuel Gauge (Lead 89)   |                       |
|   | 94. Fuel Gauge (Lead 90)   |                       |
|   | 95. Fuel Gauge (Lead 91)   |                       |
|   | 96. Fuel Gauge (Lead 92)   |                       |
|   | 97. Fuel Gauge (Lead 93)   |                       |
|   | 98. Fuel Gauge (Lead 94)   |                       |
|   | 99. Fuel Gauge (Lead 95)   |                       |
|   | 100. Fuel Gauge (Lead 96)  |                       |
|   | 101. Fuel Gauge (Lead 97)  |                       |
|   | 102. Fuel Gauge (Lead 98)  |                       |
|   | 103. Fuel Gauge (Lead 99)  |                       |
|   | 104. Fuel Gauge (Lead 100) |                       |

the gauge leads (brown and black/yellow leads) disconnected from the terminal. Remove the meter assembly bracket and the meter assembly bottom



BEFORE TROUBLESHOOTING: ...  
 TROUBLESHOOTING GUIDE: ...  
 FUEL PUMP INSPECTION: ...  
 START SIGNAL INSPECTION: ...  
 RELAY INSPECTION: ...  
 FUEL PUMP CONTACT INSPECTION: ...  
 FUEL INJECTOR INSPECTION: ...  
 IGNITION SIGNAL INSPECTION: ...  
 FUEL PRESSURE INSPECTION: ...  
 PRESSURE REGULATOR INSPECTION: ...  
 FUEL FILTER INSPECTION: ...  
 AIR FLOW METER INSPECTION: ...  
 AIR TEMPERATURE SENSOR INSPECTION: ...  
 ENGINE TEMPERATURE SENSOR INSPECTION: ...  
 IDEE SWITCH INSPECTION: ...  
 THROTTLE VALVE SWITCH INSPECTION: ...  
 HARNESS INSPECTION: ...  
 THROTTLE VALVE INSPECTION: ...  
 AIR LEAK INSPECTION: ...  
 SURGE TANK DRAIN PLO: ...  
 CAUTION: ...

# Non-scheduled Maintenance

## Table of Contents

### OTHER THAN FUEL INJECTION SYSTEM

SPEEDOMETER, TACHOMETER, ODOMETER, FUEL GAUGE, AND VOLTMETER .....	9-19
---	------

### FUEL INJECTION SYSTEM

BEFORE TROUBLESHOOTING .....	9-20
TROUBLESHOOTING GUIDE .....	9-20
FUEL PUMP INSPECTION .....	9-20
START SIGNAL INSPECTION .....	9-22
RELAY INSPECTION .....	9-22
FUEL PUMP CONTACT INSPECTION .....	9-23
FUEL INJECTOR INSPECTION .....	9-24
IGNITION SIGNAL INSPECTION .....	9-25
FUEL PRESSURE INSPECTION .....	9-25
PRESSURE REGULATOR INSPECTION .....	9-26
FUEL LEAK INSPECTION .....	9-26
FUEL SYSTEM CLEANING .....	9-26
FUEL FILTER INSPECTION .....	9-26
AIR FLOW METER INSPECTION .....	9-26
AIR TEMPERATURE SENSOR INSPECTION .....	9-27
ENGINE TEMPERATURE SENSOR INSPECTION .....	9-28
IDLE SWITCH INSPECTION .....	9-28
THROTTLE VALVE SWITCH INSPECTION .....	9-29
HARNES INSPECTION .....	9-29
THROTTLE VALVE INSPECTION .....	9-29
AIR LEAK INSPECTION .....	9-30
SURGE TANK DRAIN PLUG .....	9-30

**CAUTION**

See "SAFETY INSTRUCTIONS" on Pg. 9-3 before servicing the Kawasaki electronic fuel injection system.

A. Sponge Filter

A. Idle Adjusting Screw and Idle Switch  
B. Switch Lead

## SPEEDOMETER, TACHOMETER, ODOMETER, FUEL GAUGE, AND VOLTMETER

### Speedometer, Tachometer, and Odometer:

Test procedures for the electric meters of the KZ/Z1100B are the same as those for the KZ/Z1000J with the following exception. See Pg. 5-33 through 5-43.

#### 1. Power-supply lead voltage measurements:

Measure lead voltages at the lead end terminals (on the bottom of the meter assembly case). Remove the meter assembly bracket and the meter assembly bottom cover before measurement.

#### 2. Ignition coil signal test:

In addition to disconnecting the tachometer and IC igniter connectors, disconnect the 3-pin connector (referred to "a" in the wiring diagrams, Pgs. 9-10 through 9-11) which leads to the control unit.

### Fuel Gauge:

Test procedure for the fuel gauge of the KZ/Z1100B is the same as that of the KZ/Z1000J with the following exception. See Pg. 5-31 through 5-33.

#### 1. Fuel gauge check:

Measure the gauge internal resistance with one of

the gauge leads (brown and black/yellow leads) disconnected from the terminal. Remove the meter assembly bracket and the meter assembly bottom cover before measurement.

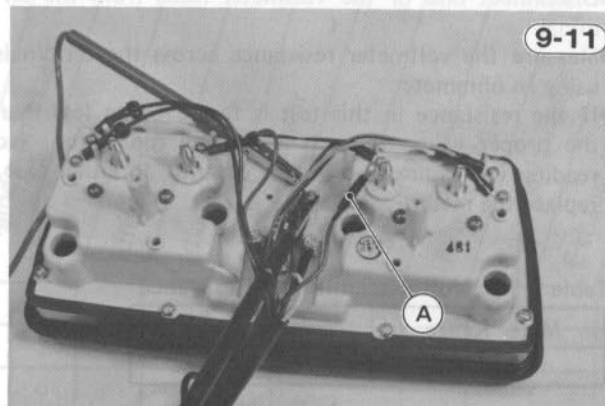

9-11

A. Remove one of gauge leads.

### Voltmeter:

The voltmeter shows the voltage across the battery terminals when the ignition switch is in the "ON" position. If the voltmeter does not appear to be functioning

9-12

### Location of Meters, Gauge, and Lights

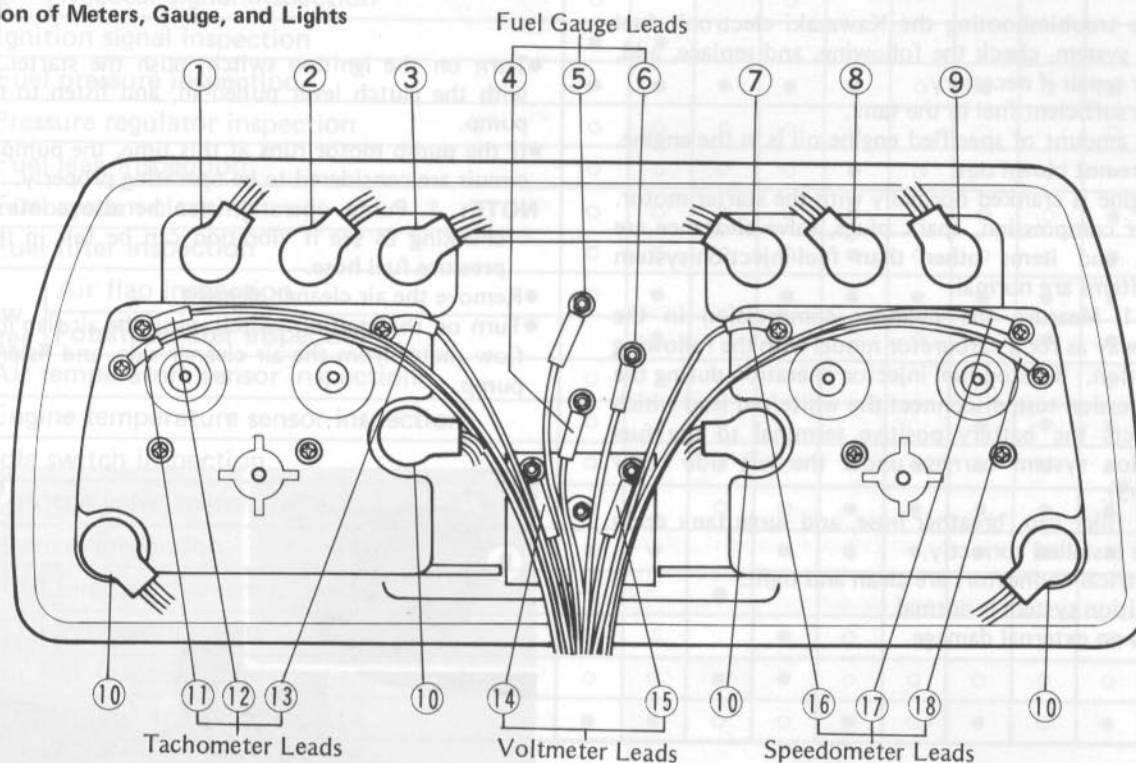

- |   |   |   |
|---|---|---|
| 1. Right Turn Signal Indicator (Gray, Black/Yellow Leads)                           | 5. Brown Lead   | 10. Meter Illuminators (Red/Blue, Black/Yellow Leads) |
| 2. US Model only: Headlight Failure Indicator (Light Green/Red, Black/Yellow Leads) | 6. Black/Yellow Lead                                      | 11. Black Lead  |
| 3. High Beam Indicator (Red/Black, Black/Yellow Leads)                              | 7. Neutral Indicator (Light Green, Brown Leads)           | 12. Black/Yellow Lead                                 |
| 4. White/Yellow Lead  | 8. Oil Pressure Warning (Blue/Red, Brown Leads)           | 13. Brown Lead  |
|   | 9. Left Turn Signal Indicator (Green, Black/Yellow Leads) | 14. Black/Yellow Lead                                 |
|   |   | 15. Brown Lead  |
|   |   | 16. Brown Lead  |
|   |   | 17. Black/Yellow Lead                                 |
|   |   | 18. Orange Lead                                       |

properly, check it by the following procedure.

- Remove the meter assembly.
- Remove the meter assembly bracket and the meter bottom cover.
- Disconnect one of the voltmeter leads from the terminal.
- Measure the voltmeter resistance across the terminals using an ohmmeter.
- ★ If the resistance in this test is found to be less than the proper value, there is a short in the meter. No reading ( $\infty$ ) indicates an open circuit. In either case, replace the meter.

Table 9-1 Voltmeter Internal Resistance

Meter Range	Reading
x 10 $\Omega$	160 – 190 $\Omega$

## BEFORE TROUBLESHOOTING

Before troubleshooting the Kawasaki electronic fuel injection system, check the following, and replace, add, adjust, or repair if necessary.

- There is sufficient fuel in the tank.
  - Correct amount of specified engine oil is in the engine.
  - Fuses are not blown out.
  - The engine is cranked normally with the starter motor.
  - Cylinder compression, spark plugs, valve clearance are normal, and items other than fuel-injection-system related items are normal.
- NOTE:** 1. Measure the cylinder compression in the same way as for a carburetor model with the following exception. To stop fuel injector operation during the compression test, disconnect the white/red lead which connects the battery positive terminal to the fuel injection system harness under the left side cover (Pg. 9-3).
- The oil filler cap, breather hose, and surge tank drain plug are installed correctly.
  - All electrical connectors are clean and tight.
  - The ignition system is normal.
  - There is no external damage.

## TROUBLESHOOTING GUIDE

Table 9-2 shows the relationship between symptoms and inspection items which could be causing the trouble.

## FUEL PUMP INSPECTION

### In-Circuit Inspection:

- Disconnect the yellow/red lead of the starter motor relay under the left side cover. This is to prevent the starter motor from working during this inspection.

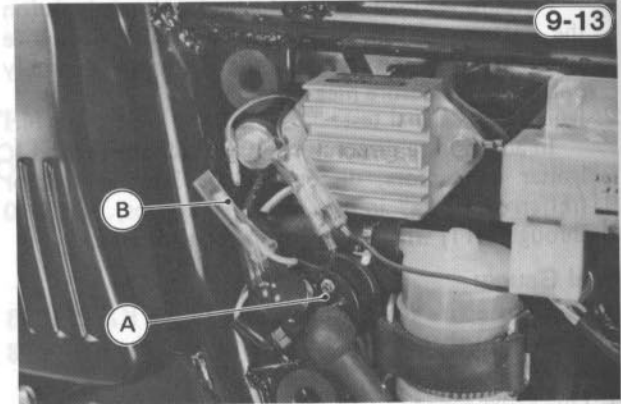

A. Starter Motor Relay B. Yellow/Red Lead

- Turn on the ignition switch, push the starter button with the clutch lever pulled in, and listen to the fuel pump.
  - ★ If the pump motor runs at this time, the pump and its circuit are considered to be operating properly.
- NOTE:** 1. Pump operation can be also confirmed by checking to see if vibration can be felt in the high-pressure fuel hose.
- Remove the air cleaner element.
  - Turn on the ignition switch, push the air flap in the air flow meter from the air cleaner side, and listen to the pump.

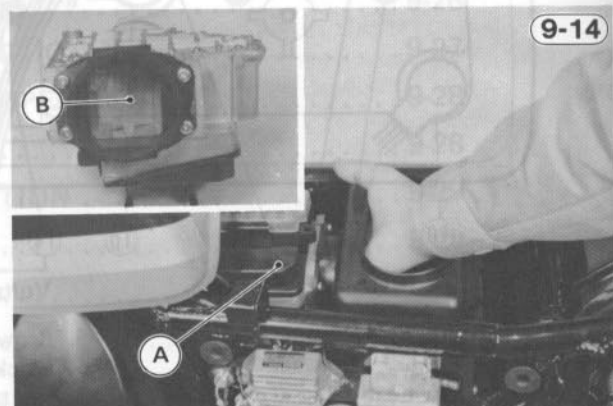

A. Air Flow Meter B. Push air flap.

- ★ If the pump motor runs at this time, the pump and its circuit are considered to operate correctly.
- ★ If the above inspection shows failure in the pump or circuit, proceed to the "Out-of-Circuit Inspection".

Table 9-2 Troubleshooting Guide

Symptoms		Operation										See Page	
		Engine won't start	Engine stalls	Idle too high	Idle rough	Lack of power	Hesitation	Backfiring	After firing	Poor gas mileage	Exhaust smokes excessively		
Fuel	In-circuit inspection	•				•	○						9-20
	Out-of-circuit inspection	○											9-22
Pump	Circuit inspection	○	○		○								9-22
Start signal inspection		•											9-22
Relay inspection		•	○										9-22
Fuel pump contact inspection		•	•										9-23
Fuel injectors	Aural inspection	•	○		•	○	○		○	○			9-24
	Injector signal inspection	○			○								9-24
Ignition signal inspection		•	•										9-25
Fuel pressure inspection		•	•	•	•	•	○	•	○	•	•		9-25
Pressure regulator inspection		○	○	○	○	○		○		○	○		9-26
Fuel leak inspection		○	○	○	○	•	○		○	•			9-26
Fuel system cleaning		○	○	○	○	•	○	○	○	•	○		9-26
Fuel filter inspection		○	○	○	○	•	○	○	○	•	○		9-26
Air Flow Meter	Air flap inspection	○	•	•	•	•	•	•	•	•	•		9-26
	Potentiometer inspection		•	○	○	○	○	•	•	•	•		9-26
Air temperature sensor inspection		○		○				•	•	•	•		9-27
Engine temperature sensor inspection		○		○				•	•	•	•		9-28
Idle switch inspection		○		○	○	•	•	•	•	•	•		9-28
Throttle valve switch inspection		○		○	○	•	•	•	•	•	○		9-29
Harness inspection		•	•	•	•	•	•	•	•	•	•		9-29
Throttle Valves	Link mechanism inspection			•									9-29
	Synchronization		○		•	○				○	•		9-29
Air leak inspection		○	○	•	•	○	○	○	○	○	○		9-30
Replace control unit		•	•	○	○	•	○	•	○	•	•		—

Table 9-3 Circuit Inspection

Meter Range	Connections	Switches				Meter Reading	Remarks
		Ignition	Starter	Starter Lockout	Fuel Pump*		
25V DC	Meter + → Orange/black lead	ON	ON	ON	OFF	Battery voltage	#1 circuit inspection
	Meter - → Black/yellow lead	ON	OFF	OFF	ON	Battery voltage	#2 circuit inspection

\*To electrically connect the fuel contacts, push the air flap in the air flow meter from the air cleaner side; and to turn off the contacts, let it return to its rest position.

**Out-of-Circuit Inspection:**

- Remove the air cleaner housing and air flow meter.
- Disconnect the 2-pin connector of the fuel pump.

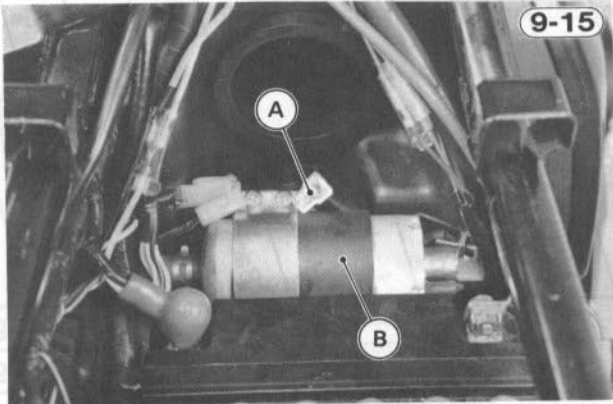

A. 2-Pin Connector      B. Fuel Pump

- Connect a 12-volt battery to the 2-pin connector (pump side), and check whether the pump operates.

**Table 9-4 Connecting Battery**

Battery + → Orange/black lead
Battery - → Black/yellow lead

- ★ If the pump does not operate, the trouble is with the pump or pump leads. Check the pump and leads, and replace them if necessary.
- ★ If the pump operates, it is normal. Proceed to "Circuit Inspection".

**Circuit Inspection:**

- Connect the 7-pin connector to the air flow meter.
- Connect a voltmeter to the 2-pin connector (harness side) to inspect the pump circuit (Table 9-3).
- ★ If the meter shows the voltage specified in Table 9-3, the pump circuit is normal.
- ★ If the #1 circuit inspection shows a circuit failure, proceed to the "Start Signal Inspection" on Pg. 9-22 and to the "Relay Inspection" on Pg. 9-22.
- ★ If the #2 circuit inspection shows a circuit failure, proceed to the "Fuel Pump Contact Inspection" on Pg. 9-23 and to the "Relay Inspection" on Pg. 9-22.

**Table 9-5 Start Signal Inspection**

Meter Range	Connections	Switches			Meter Reading
		Ignition	Starter	Starter Lockout	
25V DC	Meter + → Black lead Meter - → Black/yellow lead	ON	ON	ON	7 - 10 volts

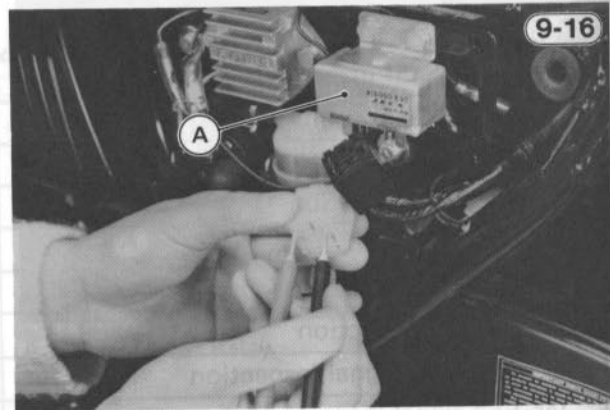

A. Relay

- ★ If the meter shows the voltage specified in the table, the start signal is being conducted to the relay connector. This shows that the wiring is in good condition.
- ★ If the meter does not show the correct voltage, inspect the leads and connectors.

**RELAY INSPECTION**

The relay is divided into two parts: the main and fuel pump relays. The two parts can be tested separately. Before starting the relay inspection, prepare a 12-volt battery, a test light (12V 3 - 3.4W), and two auxiliary leads, and remove the relay.

**Main Relay Inspection:**

- Remove the relay.
- Connect the battery to the relay terminals, two at a time, and check the conductivity between the other two terminals as specified in Table 9-6.
- ★ If the terminals specified in the table conduct, the main relay is good.

**START SIGNAL INSPECTION**

- Turn off the ignition switch.
- Disconnect the black and white 9-pin connectors from the relay under the left side cover, and connect a voltmeter to the connector to check the start signal.

**Table 9-6 Main Relay Inspection**

No.	Connections		Conductivity between #88z and #88a
	+ Lead	- Lead	
1	#86c	#85	0 Ω
2	#85	#86c	∞ Ω

**Relay Terminals**

9-17

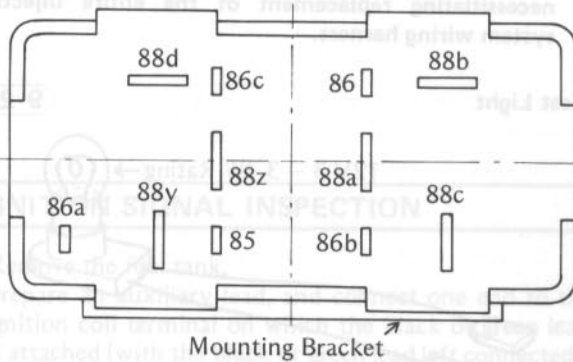

**Internal Circuit of Relay**

9-18

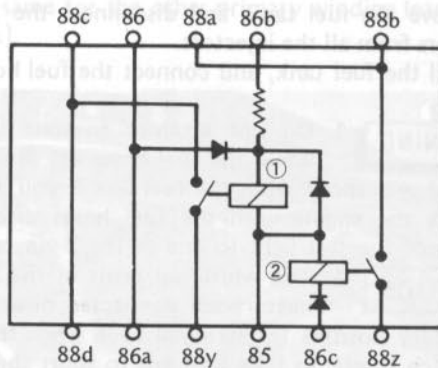

1. Fuel Pump Relay      2. Main Relay

**Fuel Pump Relay Inspection:**

**Pump relay test 1:**

Using the 12-volt battery and ohmmeter, check the pump relay as follows:

- Connect the battery to the relay terminals, two at a time, and check the conductivity between the other two terminals as specified in Table 9-7.
- ★ If the terminals conduct as shown in the table, the fuel pump relay is good.

**Table 9-7 Fuel Pump Relay Inspection**

No.	Connections		Conductivity between #88y and #88d terminals
	+ Lead	- Lead	
1	#86	#85	0 Ω
2	#85	#86	∞ Ω
3	#86a	#85	0 Ω
4	#85	#86a	∞ Ω
5	#86b	#85	0 Ω

**Pump relay test 2:**

Using the test light, 12-volt battery, and ohmmeter, check the pump relay as follows:

- Connect the battery + terminal to the relay #85 terminal.
- Connect the test light between the battery - terminal and the relay #86b terminal.

**CAUTION**

1. The test light works as an indicator and also as a current limiter to protect the resistor in the relay from excessive current. Do not connect the battery directly to the relay terminals in the "pump relay test 2," or the resistor will be burnt out.

- ★ If the light goes on and the relay does not work (the terminals #88y and #88d do not show conductivity), the fuel pump relay is good.

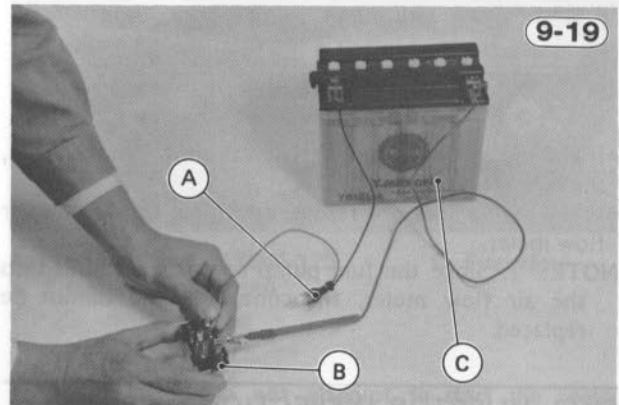

9-19

A. Test Light (12V 3 - 3.4W)      C. 12V Battery  
B. Relay

**FUEL PUMP CONTACT INSPECTION**

- Remove the air cleaner housing and air flow meter.
- Perform the "Air Flap Inspection" (Pg. 9-26).
- Pull off the right side cover.
- Turn off the ignition switch, and disconnect the 7-pin connector from the air flow meter.



9-20

A. 7-pin Connector

- Connect an ohmmeter to the air flow meter to inspect the fuel pump contacts.

**Table 9-8 Fuel Pump Contact Inspection**

Meter Range	Connections	Air Flap	Pump Contacts (Meter Reading)
x 10 Ω	One meter lead → #36 terminal	Pushed	ON (0 Ω)
	Other meter lead → #39 terminal	Released	OFF (∞ Ω)

**Air Flow Meter Terminals**

9-21

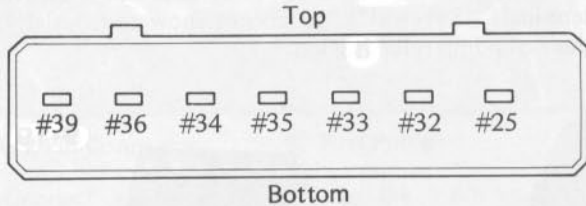

- ★ If the meter shows conductivity as shown in the table, the contacts are good.
  - ★ If the meter does not read as specified, replace the air flow meter.
- NOTE:** 1. Since the fuel pump contacts are built into the air flow meter, the contacts alone cannot be replaced.

**FUEL INJECTOR INSPECTION**

**Aural Inspection:**

- Start the engine.
- Place the tip of a screwdriver against one of the injectors. Put your ear on the grip end and listen to check whether the injector is clicking or not.
- Do the same for the other injectors.

**Aural Inspection**

9-22

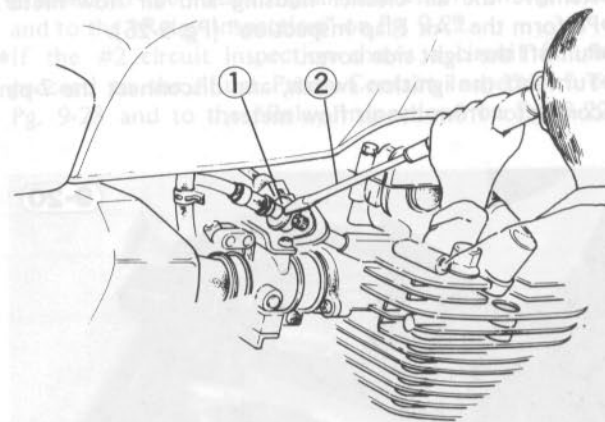

1. Fuel Injector      2. Screwdriver

- ★ If all of the injectors make clicking sounds at a regular intervals, the injectors are good.
- NOTE:** 1. The interval between clicking sounds becomes shorter as the engine speed rises.

2. If the engine does not start, perform this inspection while cranking the engine with the starter motor.
- ★ If any one of the injectors does not click, perform the "Injector Signal Inspection".

**Injector Signal Inspection:**

- Prepare a test light as shown below.

**CAUTION** 1. Do not use terminals of a size other than specified in the figure. A larger terminal could damage the injector 2-pin connector necessitating replacement of the entire injection system wiring harness.

**Test Light**

9-23

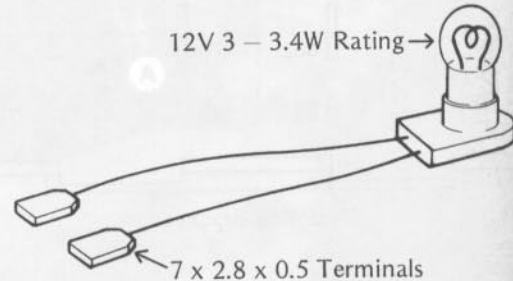

- Remove the fuel tank, and disconnect the 2-pin connectors from all the injectors.
- Install the fuel tank, and connect the fuel hoses to the tank.

**WARNING** 1. Do not attempt to start the engine while the fuel hoses are disconnected.

Fuel will spout from the fuel line if you attempt to start the engine with the fuel hoses disconnected.

- Connect the test light to one of the 2-pin connectors.

**CAUTION** 1. The white/red leads in the 2-pin connectors are connected directly to the battery positive (+) terminal even when the ignition switch is off, so take care not to short the test light leads to the chassis ground.

- While cranking the engine with the starter motor, watch the test light.
- Do the same for the other 2-pin connectors.

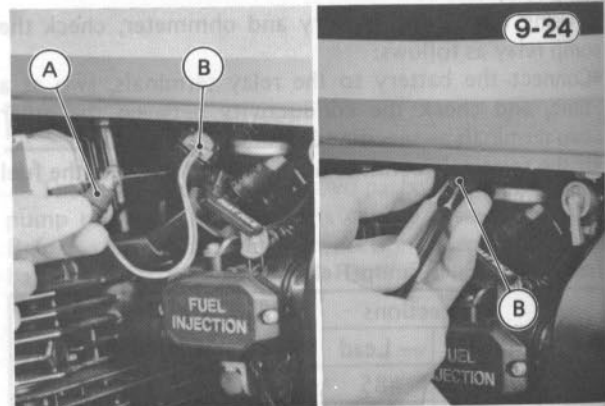

A. Test Light      B. 2-pin Connector

- ★ If the test light flickers at regular intervals, the wiring is good.



**NOTE:** 1. Injector signals can be also confirmed by connecting a voltmeter (set to the 10V AC range) to the 2-pin connector and checking to see if the voltmeter oscillates at regular intervals.

- ★If the test light flickers, but the injector did not click in the "Aural Inspection", replace the injector with a new one.
- ★If the test light does not flicker, check the wiring and connectors. If the wiring is good, perform the "Ignition Signal Inspection".

## IGNITION SIGNAL INSPECTION

- Remove the fuel tank.
- Prepare an auxiliary lead, and connect one end to the ignition coil terminal on which the black or green lead is attached (with the black or green lead left connected).
- Turn on the ignition switch, and listen to the injectors while grounding the other end of the auxiliary lead repeatedly to the engine.
- Do the same for the other primary winding lead (green or black).

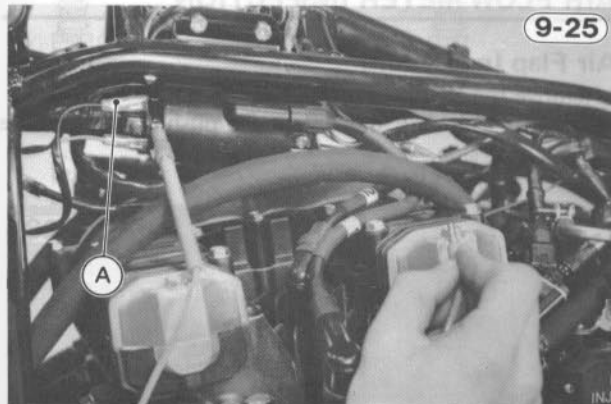

A. Black or Green Lead

B. Ignition Coil

- ★The two motions, grounding the auxiliary lead and then removing it, are considered one cycle; the injectors should click every second cycle.
- ★If the injectors do not click, check the wiring and connections. If the wiring is good, replace the control unit.

## FUEL PRESSURE INSPECTION

**If the engine will start:**

- Remove the fuel tank, and pull the fuel hose off the right end of the fuel distributing pipe.

### WARNING

1. When the fuel hose is pulled off, small amount of fuel may spout out because of residual pressure in the fuel line. Cover the hose connection with a clean cloth to prevent the fuel from flying about.

- Install the pressure gauge (special tool) between the distributing pipe and the hose disconnected using the adapter (special tool) and high-pressure fuel hose.
- Tighten the hose clamps in the correct position (Pg. 9-34).

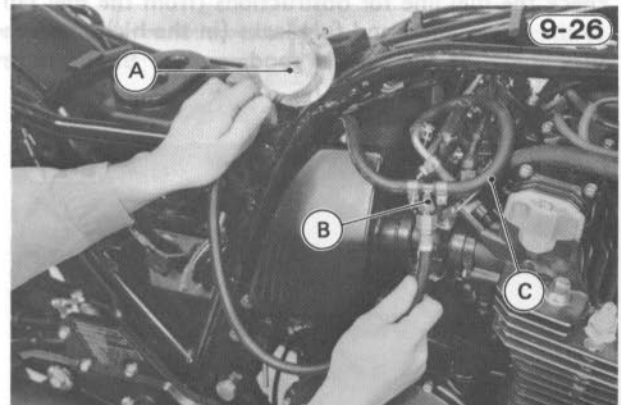

A. Pressure Gauge: 57001-125

B. Adapter: 57001-1089

C. Fuel Hose

- Install the fuel tank.

### WARNING

1. Do not attempt to start the engine while the fuel hoses are disconnected.

- Start the engine, and read the gauge.

Table 9-9 Fuel Pressure

Conditions	Reading*
Engine idling	about 2.3 kg/cm <sup>2</sup> (230 kPa, 33 psi)
The moment throttle is fully opened	about 2.5 kg/cm <sup>2</sup> (250 kPa, 36 psi)

\*The gauge needle will oscillate. Read the pressure at the average of the maximum and the minimum indications.

- ★If the gauge shows the pressure specified in the table, the fuel pressure is good.
- ★If the fuel pressure is abnormal, refer to the "Pressure Regulator Inspection".

**If the engine will not start:**

- Install the pressure gauge (special tool) in the fuel pressure line as explained in the "If the engine will start" section.
- Remove the air cleaner element.
- Turn on the ignition switch, and push the air flap in the air flow meter from the air cleaner side to start the fuel pump.
- ★If the gauge reads about 2.5 kg/cm<sup>2</sup> (250 kPa, 36 psi), the fuel pressure is good.
- ★If the fuel pressure is abnormal, refer to the "Pressure Regulator Inspection".

## PRESSURE REGULATOR INSPECTION

- Check the fuel pressure.
- ★ If the fuel pressure is higher than the specified values (refer to the "Fuel Pressure Inspection"), check the fuel return line (from the pressure regulator to the check valve in the tank) for obstructions, and the vacuum hose of the pressure regulator for air leaks. If they prove good, replace the pressure regulator.
- ★ If the fuel pressure is lower than the specified values, check the fuel line for obstructions (from the fuel tap to the pump inlet) and fuel leaks (in the high-pressure fuel line). If the line is good, replace the pressure regulator or fuel pump.

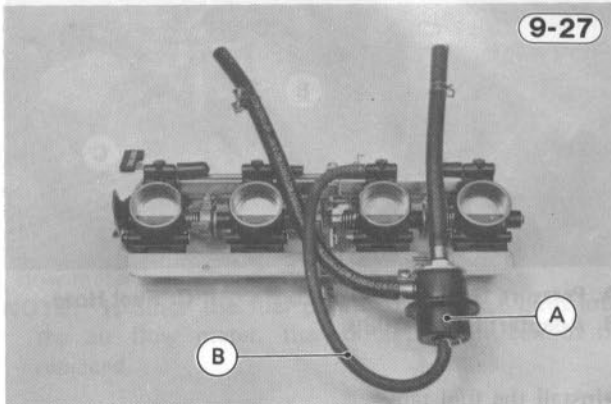

A. Pressure Regulator      B. Vacuum Hose

## FUEL LEAK INSPECTION

Inspect the connections between the parts shown in Fig. 9-29 for leaks.

## FUEL SYSTEM CLEANING

- WARNING** 1. Clean the fuel system in a well-ventilated area, and take ample care there are no sparks or flame anywhere near the working area.
2. Never clean out the fuel system when the engine is still warm.
  3. Wipe any fuel off the engine before starting it.
    - Remove the fuel tank, and drain it.
    - Remove the fuel tap from the tank, and clean the fuel tap filter with a high flash-point solvent.
    - Flush out the fuel tank with a high flash-point solvent.
    - Clear the air vent in the tank cap with compressed air.

- Remove the fuel pump, fuel injectors, fuel distributing pipe, and pressure regulator; and clean them using a high flash-point solvent.
- Replace the fuel filter and hoses with new ones.
- Install the parts on the motorcycle. Use new hose clamps.

## FUEL FILTER INSPECTION

Regular replacement of the fuel filter is required (Pg. 9-14), but replacement is not otherwise necessary unless the filter has been damaged.

If water accumulates in the filter, clean the fuel system. See above.

## AIR FLOW METER INSPECTION

### Air Flap Inspection:

- Remove the air flow meter.
- Check the air flap movement by pushing it from the air cleaner side.

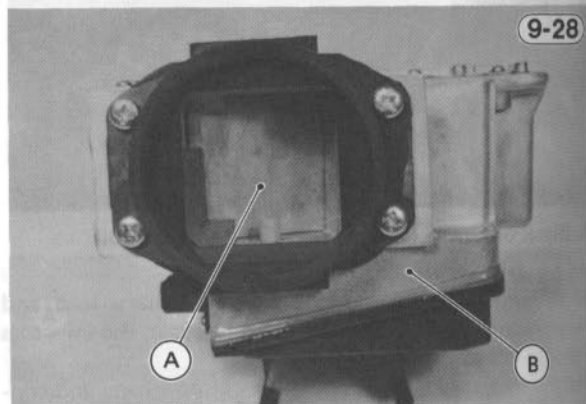

A. Flap      B. Air Flow Meter

- ★ The flap should swing smoothly without binding, and the return spring should swing the flap back to the rest position.
- ★ If the flap does not move smoothly, or does not return to the closed position, replace the air flow meter.

### Potentiometer Inspection:

- Turn off the ignition switch, and disconnect the 7-pin connector from the air flow meter.
- Connect an ohmmeter to the air flow meter according to Table 9-10, and measure the internal resistance.

Fuel Leak Inspection

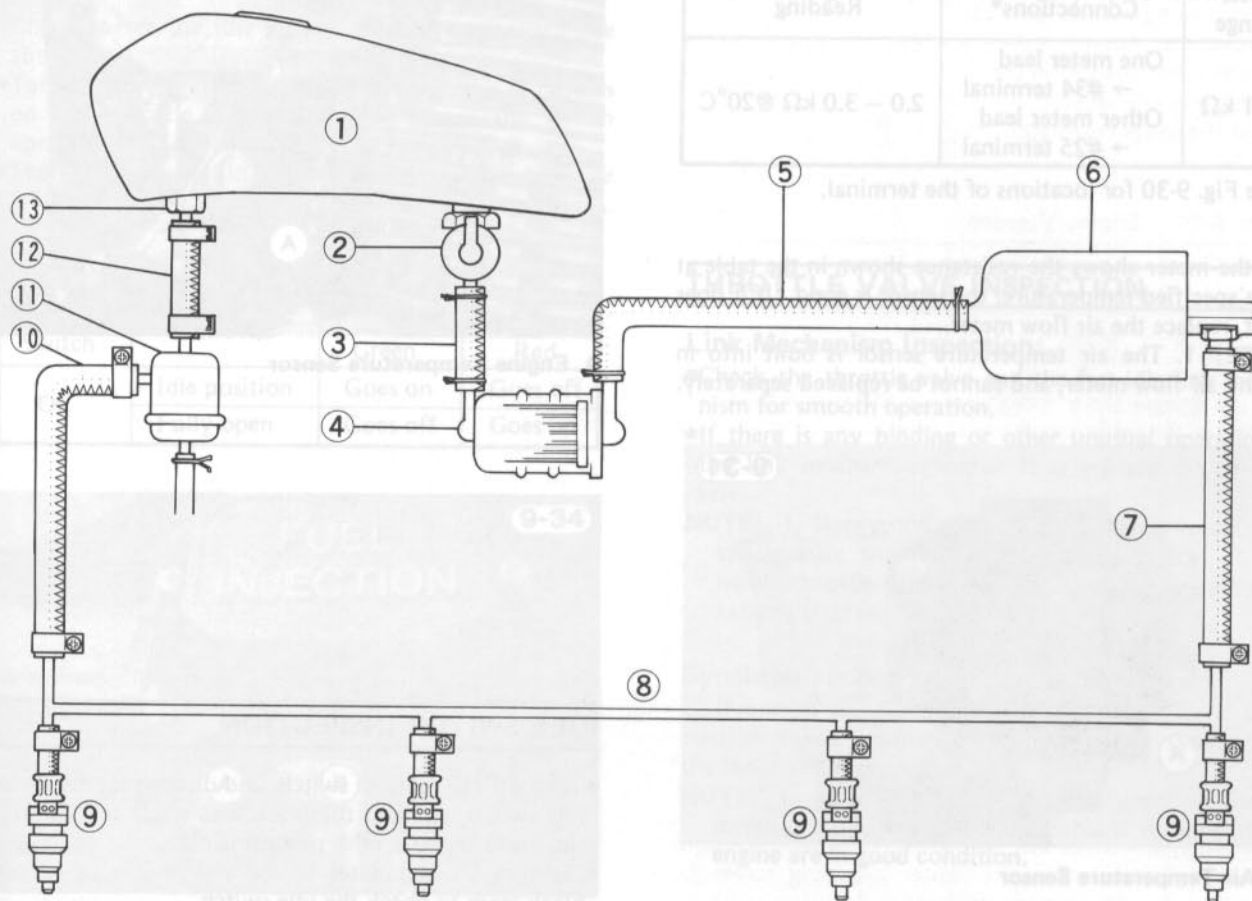

- 1. Fuel Tank
- 2. Fuel Tap
- 3. Fuel Hose (low pressure)
- 4. Fuel Filter
- 5. Fuel Hose (low pressure)
- 6. Fuel Pump
- 7. Fuel Hose (high pressure)
- 8. Fuel Distributing Pipe
- 9. Fuel Injectors
- 10. Fuel Hose (high pressure)
- 11. Pressure Regulator
- 12. Fuel Hose (low pressure)
- 13. Check Valve

Table 9-10 Potentiometer Inspection

Meter Range	Connections	Reading
x 100 Ω	One meter lead → #34 terminal Other meter lead → #35 terminal	250 – 400 Ω
	One meter lead → #32 terminal Other meter lead → #33 terminal	Any values other than 0 or ∞ Ω with flap in any position.

- ★ If the meter shows the resistances specified in the table, the potentiometer is good. If it does not, replace the air flow meter.
- Clean off any dirt on the air passage wall and air flap with a piece of clean, dry cloth.

Air Flow Meter Terminals

9-30

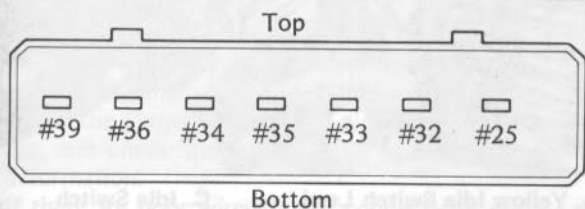

AIR TEMPERATURE SENSOR INSPECTION

- Turn off the ignition switch, and disconnect the 7-pin connector from the air flow meter.
- Connect an ohmmeter to the air flow meter to measure the resistance of the air temperature sensor.

**Table 9-11 Air Temperature Sensor Inspection**

Meter Range	Connections*	Reading
x 1 kΩ	One meter lead → #34 terminal Other meter lead → #25 terminal	2.0 – 3.0 kΩ @20°C

\*See Fig. 9-30 for locations of the terminal.

★If the meter shows the resistance shown in the table at the specified temperature, the sensor is good. If it does not, replace the air flow meter.

**NOTE:** 1. The air temperature sensor is built into in the air flow meter, and cannot be replaced separately.

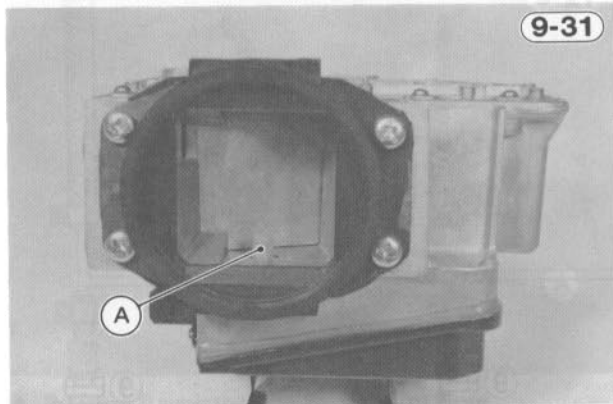

9-31

**A. Air Temperature Sensor**

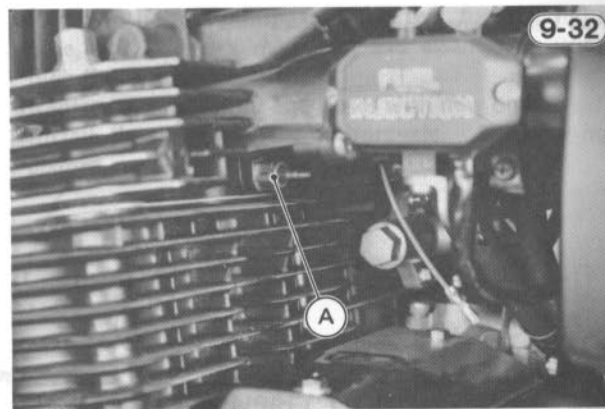

9-32

**A. Engine Temperature Sensor**

**IDLE SWITCH INSPECTION**

- Turn off the ignition switch, and disconnect the yellow idle switch lead and the black lead which is secured on the lower throttle valve mounting plate.
- Connect an ohmmeter to the yellow idle switch and black leads to check the idle switch.
- ★If the switch conducts as shown in Table 9-13, the switch is good.

**Table 9-13 Idle switch inspection**

Meter Range	Connections	Throttle	Reading
x 10 Ω	One meter lead → Yellow lead	Idle position	0 Ω
	Other meter lead → Black lead	Other than idle position	∞ Ω

**ENGINE TEMPERATURE SENSOR INSPECTION**

- Turn off the ignition switch, and disconnect the lead from the engine temperature sensor.
- Measure the resistance of the sensor with an ohmmeter.
- ★If the meter shows the resistance shown in the table at the specified temperature, the sensor is good.

**Table 9-12 Engine Temperature Sensor Inspection**

Meter Range	Connections	Reading
x 1 kΩ	One meter lead → Sensor terminal Other meter lead → Chassis ground	2.0 – 3.0 kΩ @20°C

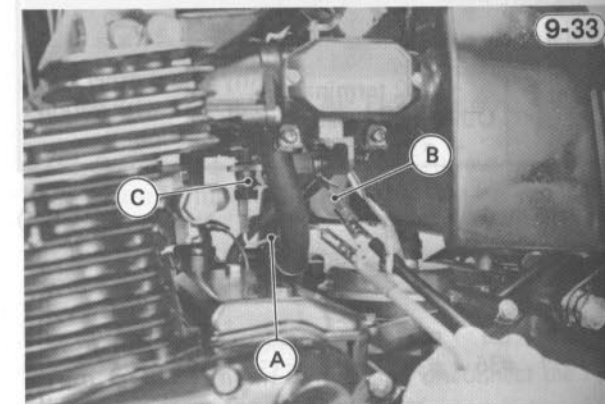

9-33

**A. Yellow Idle Switch Lead      C. Idle Switch  
B. Black Lead**

## THROTTLE VALVE SWITCH INSPECTION

- Check to see the idle switch operates correctly. See above.
- Turn on the ignition switch, and watch the indicators on the throttle valve switch to know the switch operation.
- ★ The indicators should go on and off as shown in Table 9-14. If they do not, inspect the electrical connections.

Table 9-14 Throttle Valve Switch Operation

Ignition Switch	Throttle	Indicators	
		Green	Red
On	Idle position	Goes on	Goes off
	Fully open	Goes off	Goes on

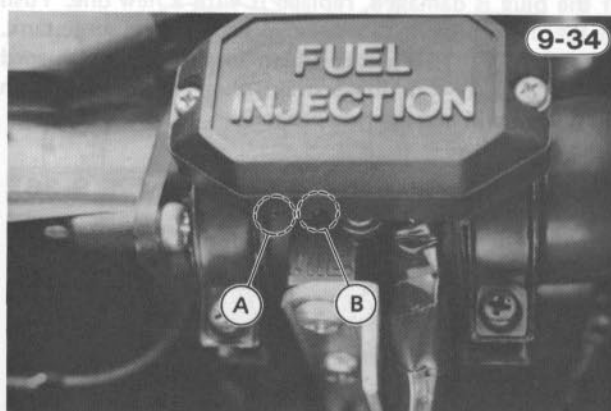

A. Green Indicator

B. Red Indicator

## HARNESS INSPECTION

If each component checks out good upon individual inspection, but the system does not work well when they are connected together, inspect the harness for the electronic fuel injection system as follows:

- Remove the harness.
- Make sure all connectors are clean and tight, and none of the male pins in the connector have been displaced during the connection of the connector. Tug on the wires to see if any pins are loose. Push any loose pins all the way into the connector until you feel the small locking tang catch in place.
- Examine wires for signs of burning, fraying, etc.
- Check conductivity of the wires in the harness. Both ends of the same color wire should conduct.
- Check the O-ring in the multi-pin connectors for damage, and check the retaining clip of the connector for deformation.
- ★ If there are poor wires or bad connections, replace the harness.

- ★ If there are open wires, replace the harness.
- ★ If the O-rings or clips are damaged, replace them.

## THROTTLE VALVE INSPECTION

### Link Mechanism Inspection:

- Check the throttle valve and the fast idle link mechanism for smooth operation.
- ★ If there is any binding or other unusual operation in the link mechanism, repair it or replace the throttle valve.

**NOTE:** 1. If any one of the throttle valves is replaced, synchronize the valves as explained below. If the whole throttle valve assembly is replaced, synchronization is not required.

### Synchronization:

If one of the throttle valves is replaced, or if combustion varies from cylinder to cylinder, synchronize the throttle valves.

**NOTE:** 1. These procedures are explained on the assumption that the intake and exhaust systems of the engine are in good condition.

### Checking engine vacuum:

- Warm up the engine thoroughly.
- Remove the fuel tank, and put it on the work bench near the motorcycle on the same level as the original position.
- US model: Pull off the three vacuum hoses and rubber cap from the fittings on the throttle valves, one hose for the pressure regulator and two for the vacuum switch valve.
- Other than US model: Pull off the two vacuum hoses for the pressure regulator and the two rubber caps from the fittings on the throttle valves.
- Attach the vacuum gauge (special tool) to the fittings.

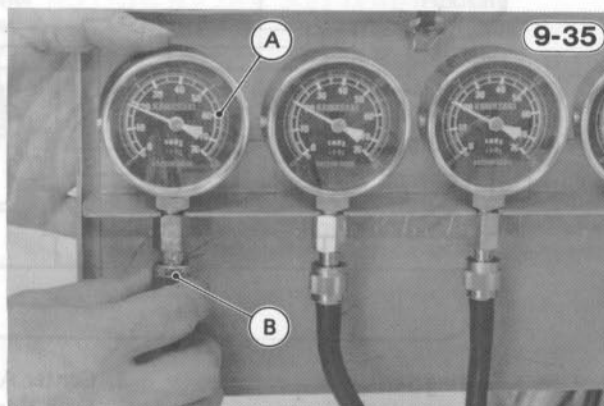

A. Vacuum Gauge Set: 57001-127

B. Damper Valve

- Using suitable hoses, connect the fuel tap to the fuel filter, and the check valve to the pressure regulator.
- Start the engine, and let it idle.
- Adjust the damper valves so that the gauge needle flutter is less than 3 cm Hg.
- Adjust the idle speed.
- Note the gauge readings.

\*See Fig. 9-30 for locations of the terminal

**Table 9-15 Engine Vacuum**

Difference between any two cylinders	Less than 2 cm Hg
--------------------------------------	-------------------

★If the gauges show more vacuum difference than specified in the table, synchronize the valves.

**NOTE:** 1. After checking or synchronizing the valves, and installing the fuel tank, adjust the idle speed.

**Synchronizing the throttle valves:**

- Stop the engine.
- To change the vacuum, loosen the locknut, and turn the balance adjusting screw.

**NOTE:** 1. Loosen the locknut with the throttle valves opened.

2. First synchronize the left two or right two cylinders by means of the adjusting screw ① or ② between #1 and #2 cylinders, or #3 and #4 cylinders (Fig. 9-37). Then synchronize the left two cylinders and the right two cylinders using the center adjusting screw ③. Adjust the idle speed as necessary.

- Tighten the locknuts.
- Open and close the throttle a few times to make sure that the throttle valves are synchronized. Readjust if necessary.
- Install all parts previously removed, and adjust the idle speed.

**Adjusting Screw for Synchronization**

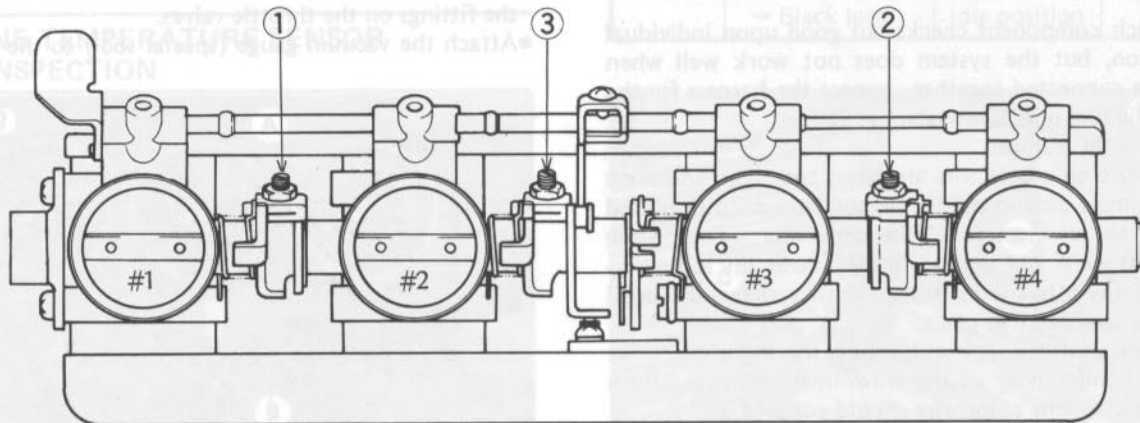

1. Left Adjusting Screw:  
Turn this screw clockwise to lower #1 cylinder vacuum.

3. Center Adjusting Screw:  
Turn this screw clockwise to lower #1 and #2 cylinder vacuum simultaneously.

2. Right Adjusting Screw:  
Turn this screw clockwise to lower #4 cylinder vacuum.

**AIR LEAK INSPECTION**

- Inspect the connections between the parts shown in Fig. 9-38 for air leaks.

**SURGE TANK DRAIN PLUG**

A drain plug is provided at the bottom of the surge tank. Usually water, oil, etc. do not collect at the bottom of the tank. In the event that rain water is drawn in through the air cleaner, or if engine oil is blown back; pull off the drain plug, and drain the surge tank.

Before installing the drain plug, check it for damage. If the plug is damaged, replace it with a new one. Push in the drain plug until its flange seats on the surge tank.

**CAUTION** 1. If air is drawn in through a damaged or loose drain plug, the fuel injection system will not operate properly.

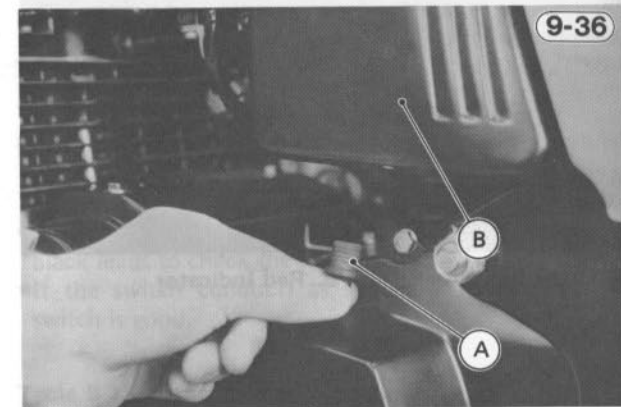

A. Drain Plug B. Surge Tank

9-36

9-37

**Air Leak Inspection**

9-38

**OIL HOSES**

**Removal:**

**Oil Cooler Removal**

- Remove the oil hose fitting bolts (1) and the oil hoses from the oil cooler. There is an O-ring seal at the end of the hose.
- Remove the mounting bolts (9) and remove the cooler together with brackets from the engine.

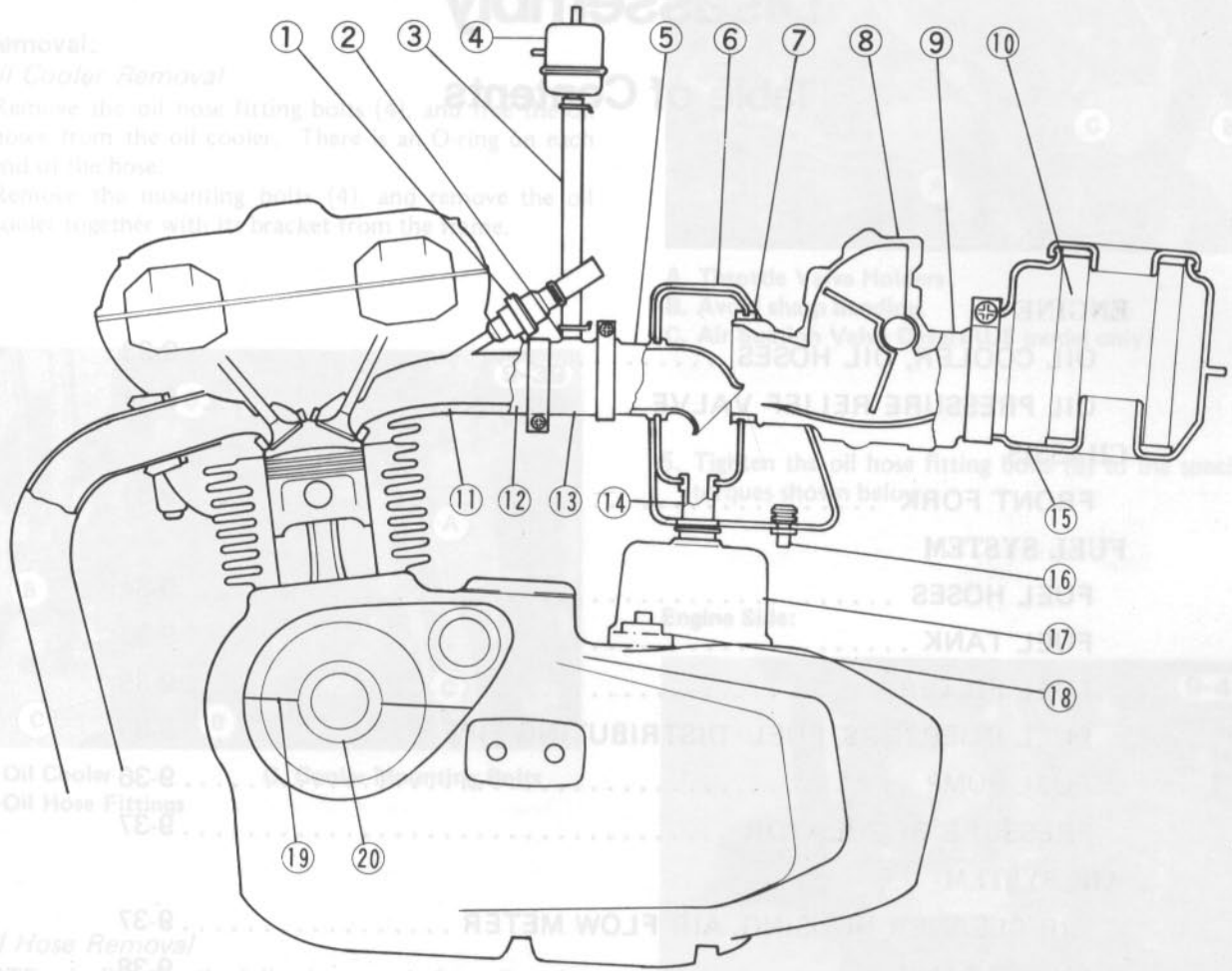

A. Oil Cooler  
B. Oil Hose Fittings

**Oil Hose Removal**

NOTE: 1. Remove the following parts before oil cooler removal.

- |                                     |                               |                            |
|-------------------------------------|-------------------------------|----------------------------|
| 1. Fuel Injectors                   | 8. Air Flow Meter             | 14. Breather Hose          |
| 2. Rubber Caps<br>(on hose fitting) | 9. Rubber Fitting             | 15. Air Cleaner<br>Housing |
| 3. Vacuum Hose                      | 10. Air Cleaner<br>Element    | 16. Drain Plug             |
| 4. Pressure Regulator               | 11. Cylinder Head             | 17. Breather Cover         |
| 5. Air Ducts                        | 12. Throttle Valve<br>Holders | 18. Oil Filler Cap         |
| 6. Surge Tank                       | 13. Throttle Valves           | 19. Mating Surfaces        |
| 7. Rubber Seal                      |                               | 20. Oil Seals              |

- NOTE: 1. The left side hose is longer than the right side one.
2. Run the left side hose between the air filter and the oil cooler. There is an O-ring seal at the end of the hose with operation of the throttle linkage.
3. Run the right side hose between the right and left throttle valve holders, and left side of the fuel sender, and then to the right side of the oil cooler.
4. US model: Run both oil hoses outside the air suction valve covers.

A. 0.80 kg-m (60 in-lb) of Torque

**AIR LEAK INSPECTION**

Inspect the connections between the parts shown in Fig. 9-32 for air leaks.

# Disassembly

## Table of Contents

Table 9-15 Engine Vacuum

Difference between any two cylinders	Less than 2 cm Hg
--------------------------------------	-------------------

**ENGINE**

OIL COOLER, OIL HOSES ..... 9-33

OIL PRESSURE RELIEF VALVE ..... 9-34

**CHASSIS**

FRONT FORK ..... 9-34

**FUEL SYSTEM**

FUEL HOSES ..... 9-34

FUEL TANK ..... 9-35

FUEL FILTER ..... 9-35

FUEL INJECTORS, FUEL DISTRIBUTING PIPE ..... 9-35

FUEL PUMP ..... 9-36

PRESSURE REGULATOR ..... 9-37

**AIR SYSTEM**

AIR CLEANER HOUSING, AIR FLOW METER ..... 9-37

SURGE TANK ..... 9-38

THROTTLE VALVES ..... 9-38

**ELECTRONIC CONTROL SYSTEM**

CONTROL UNIT ..... 9-40

RELAY ..... 9-40

THROTTLE VALVE SWITCH ..... 9-41

ENGINE TEMPERATURE SENSOR ..... 9-41

BATTERY ..... 9-41

FUEL INJECTION SYSTEM HARNESS ..... 9-41

**CAUTION**

See "SAFETY INSTRUCTIONS" on Pg. 9-3 before servicing the Kawasaki electronic fuel injection system.

1. Left Adjusting Screw:  
Turn this screw clockwise to lower #1 cylinder vacuum.

3. Center Adjusting Screw:  
Turn this screw clockwise to lower #1 and #2 cylinder vacuum simultaneously.

2. Right Adjusting Screw:  
Turn this screw clockwise to lower #4 cylinder vacuum.



**OIL COOLER  
OIL HOSES**

**Removal:**

**Oil Cooler Removal**

- Remove the oil hose fitting bolts (4), and free the oil hoses from the oil cooler. There is an O-ring on each end of the hose.
- Remove the mounting bolts (4), and remove the oil cooler together with its bracket from the frame.

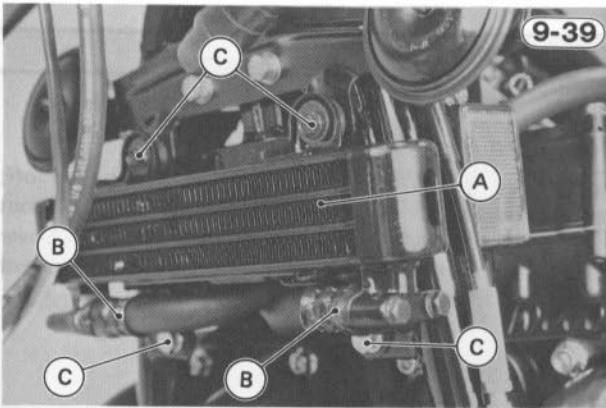

A. Oil Cooler  
B. Oil Hose Fittings  
C. Cooler Mounting Bolts

**Oil Hose Removal**

**NOTE:** 1. Remove the following parts before oil cooler removal.

- Fuel tank
- Air cleaner housing
- Air flow meter
- Throttle valve switch
- Surge tank
- Pressure regulator
- Throttle valves

**Installation:**

**Oil Hose Installation**

- NOTE:** 1. The left side hose is longer than the right side one.
2. Run the left side hose between the #1 and the #2 throttle valve holders and then to the left side of the oil cooler. Be sure the oil hose does not interfere with operation of the throttle linkage.
  3. Run the right side hose between the #3 and #4 throttle valve holders, and left side of the fuel level sender, and then to the right side of the oil cooler.
  4. US model: Run both oil hoses outside the air suction valve covers.

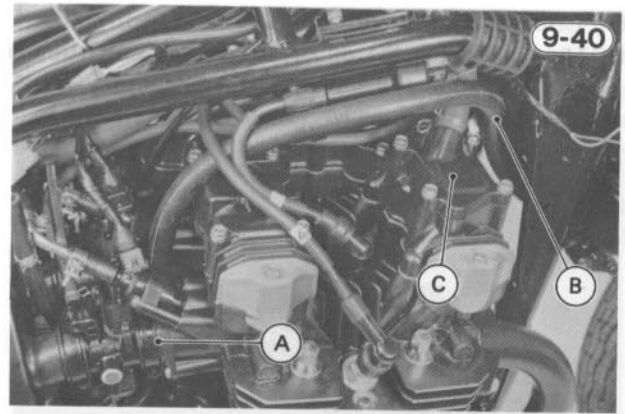

A. Throttle Valve Holders  
B. Avoid sharp bending.  
C. Air Suction Valve Covers (US model only)

5. Tighten the oil hose fitting bolts (8) to the specified torques shown below.

**Engine Side:**

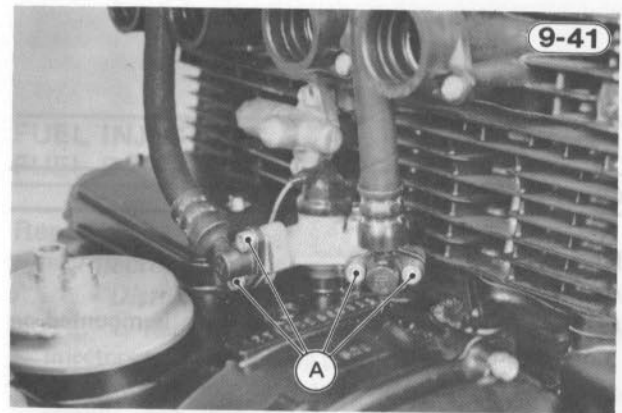

A. 1.0 kg-m (87 in-lbs) of Torque

**Oil Cooler Side:**

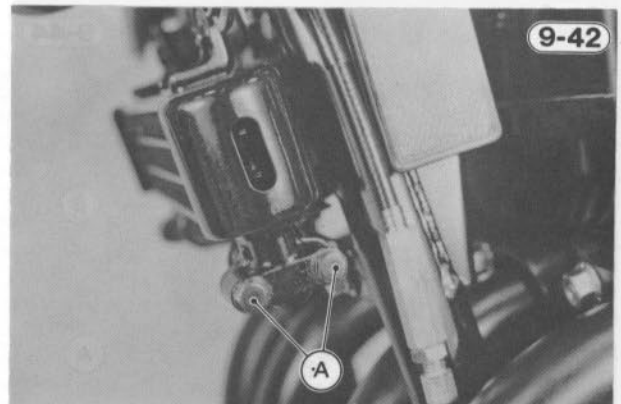

A. 0.80 kg-m (69 in-lbs) of Torque

**Oil Cooler Installation**

**NOTE:** 1. Tighten the oil cooler bracket bolts to the specified torque shown below.

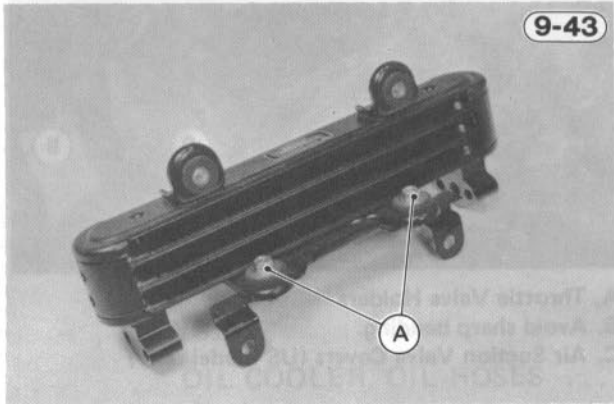

**A. 1.0 kg-m (87 in-lbs) of Torque**

2. Check the engine oil level after installation.

**FRONT FORK**

**Disassembly and Assembly:**

**Front Fork Disassembly and Assembly**

**NOTE:** 1. Disassembly and assembly procedure of the KZ/Z1100B is the same as that of the KZ/Z1000K.

**OIL PRESSURE RELIEF VALVE**

**Removal:**

**Relief Valve Removal**

**NOTE:** 1. The oil pressure relief valve is mounted on the engine oil pump.

**Installation:**

**Relief Valve Installation**

**NOTE:** 1. Apply a non-permanent locking agent to the relief valve and torque it to 1.5 kg-m (11.0 ft-lbs).

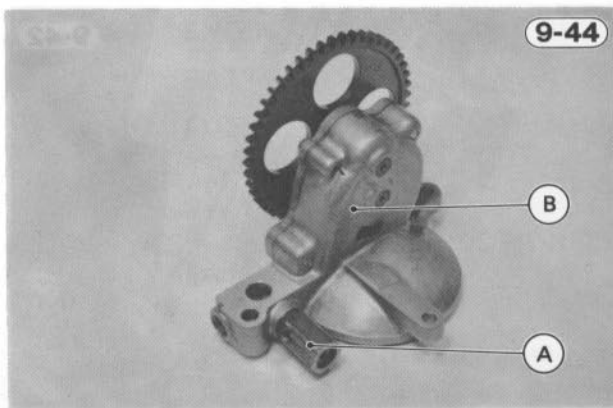

**A. Relief Valve**

**B. Oil Pump**

**FUEL HOSES**

**Removal:**

**Fuel Hose Removal**

**WARNING**

1. When the fuel hoses are pulled off, a small amount of fuel may spout out because of residual pressure in the fuel line. Cover the hose connection with a clean cloth to prevent the fuel from flying about.

**Installation:**

**Fuel Hose Installation**

**NOTE:** 1. The inner surface of the high-pressure fuel hoses are coated with a special material. If this special layer is damaged, replace the hose with a new one. Also replace the hose if it is sharply bent or kinked.

2. Discard the old hose clamps, and use new clamps when assembling the system.
3. Route the fuel hoses with a minimum of bending so that the fuel flow will not be obstructed.
4. Install the clamps for the high-pressure fuel hoses in the position indicated in the figure below.

**Hose Clamp Installation**

**9-45**

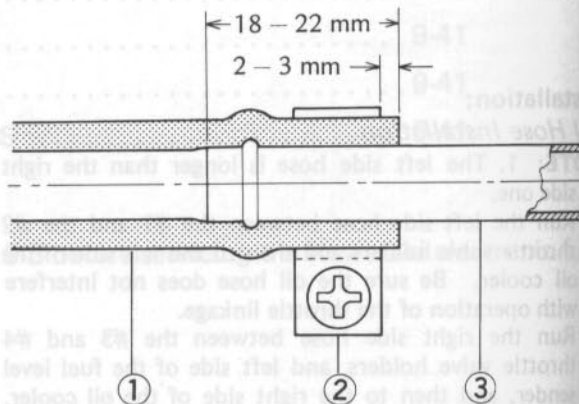

1. Fuel Hose
2. Clamp
3. Pipe or Fitting

## FUEL TANK

### Removal:

#### Fuel Tank Removal

**WARNING** 1. Do not attempt to start the engine while the fuel hoses are disconnected.

If you attempt to start the engine with the fuel hoses disconnected, fuel will be pumped out of the return fuel hose.

### Installation:

#### Fuel Tank Installation

**NOTE:** 1. Connect the fuel hose, which comes from the pressure regulator to the check valve; and connect the fuel hose, which comes from the fuel filter, to the fuel tap.

**NOTE:** 2. The pressure regulator is installed under the

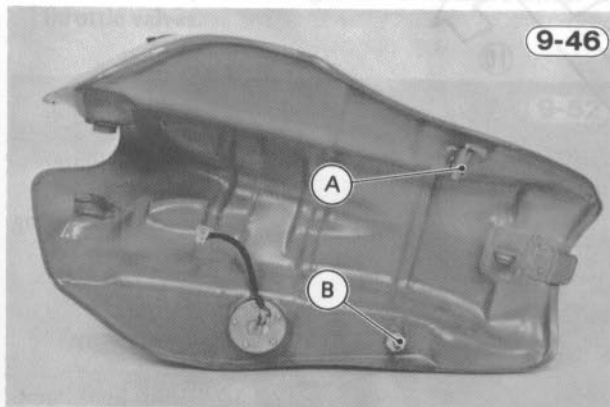

A. Fuel Tap

B. Check Valve

## FUEL FILTER

### Removal:

#### Fuel Filter Removal

**WARNING** 1. Perform these procedures in a well-ventilated area, and take care that there is no spark or flame anywhere near the working area.

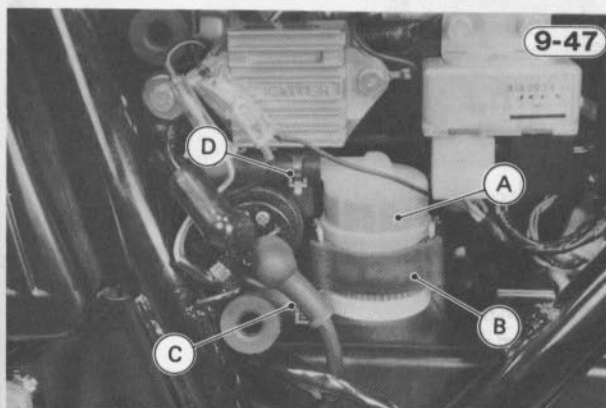

A. Fuel Filter

C. To pump

B. Band

D. From tank

### Installation:

#### Fuel Filter Installation

**NOTE:** For the fuel filter enables the fuel pump to bleed the air immediately when re-starting the engine after running out of fuel, observe the following:

1. Install the filter so that the "IN" side is on top.
2. Install the fuel hose to the fuel pump on the lower fitting (marked "OUT"), and the hose from the fuel tank on the upper fitting (marked "IN").

#### Fuel Filter Installation

9-48

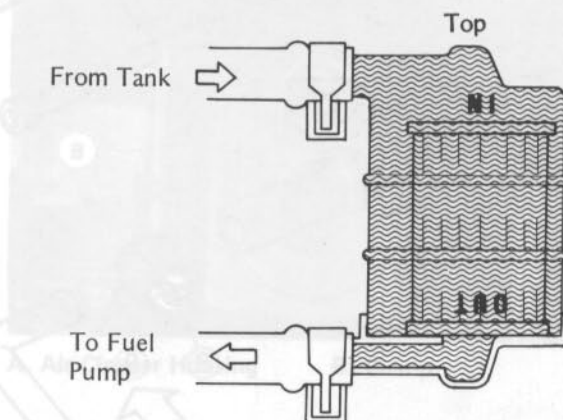

### Air Flow Meter Removal

**WARNING** Do not start the engine while the fuel injector is disconnected. This could damage the engine with

**NOTE:** 1. Lubricate the mating surfaces before the

## FUEL INJECTORS

### FUEL DISTRIBUTING PIPE

### Removal:

#### Fuel Injector and Fuel Distributing Pipe Removal

**NOTE:** 1. Remove the fuel tank before removal of the injectors and distributing pipe.  
2. Remove the injectors and distributing pipe as assembly, and then separate the injectors from the distributing pipe.

**CAUTION** 1. Do not damage injector nozzles. A damaged nozzle will adversely affect the injector performance.

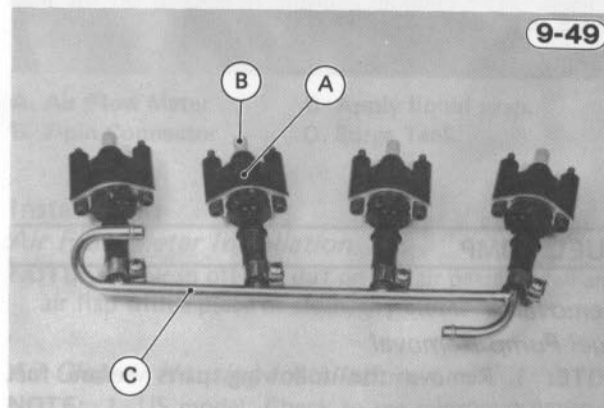

A. Injector

B. Nozzle

C. Fuel Distributing Pipe

**Fuel Injector, Fuel Distributing Pipe**

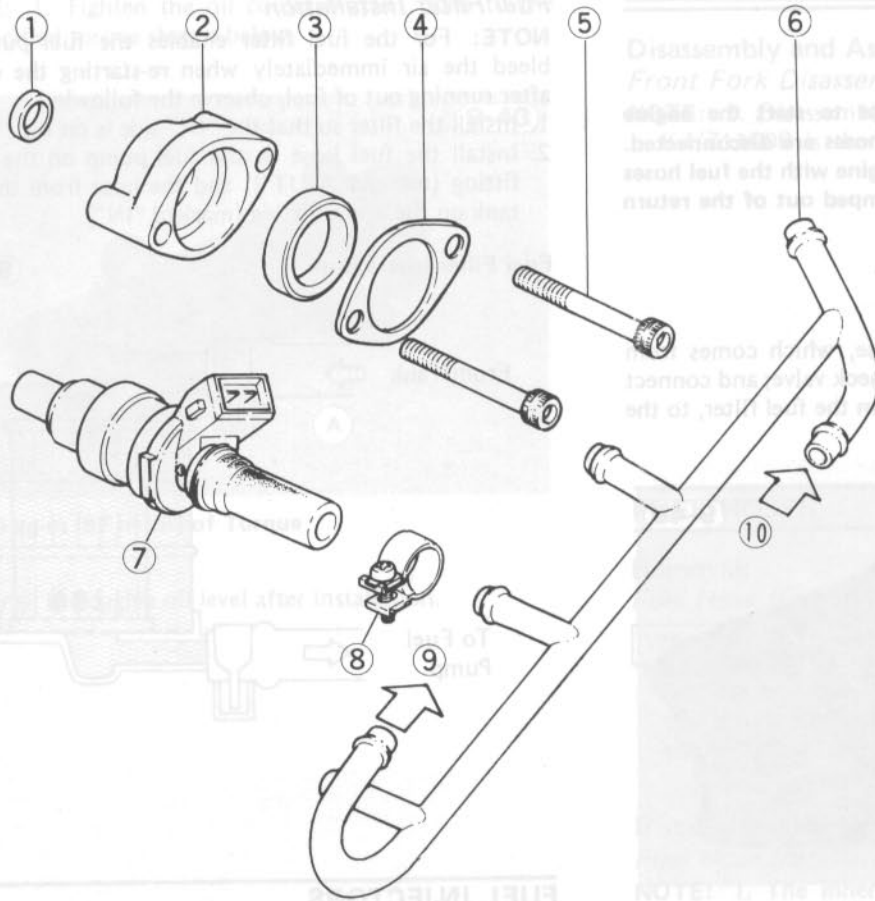

1. Seal
2. Holder
3. Damper
4. Holding Plate
5. Allen Bolt
6. Fuel Distributing Pipe
7. Fuel Injector
8. Clamp
9. To Pressure Regulator
10. From Fuel Pump

**Installation:**

**Fuel Injector and Fuel Distributing Pipe Installation**

- NOTE:** 1. Check the seal (1) and damper (3) for deterioration or other damage, and replace them if necessary.  
 2. Observe the "Fuel Hose Installation Notes" (Pg. 9-34).  
 3. Tighten the injector mounting bolts (5) (8) to 0.50 kg-m (43 in-lbs) of torque.  
 4. Tighten the hose clamps after all injectors and fuel distributing pipe are correctly positioned in place.  
 5. The four 2-pin connectors differ in the length of their leads. The cylinder number is marked on the lead sheath.

2. The fuel pump is secured by the screws (2) and holding plate.

**FUEL PUMP**

**Removal:**

**Fuel Pump Removal**

- NOTE:** 1. Remove the following parts before fuel pump removal.
- Air cleaner
  - Air flow meter

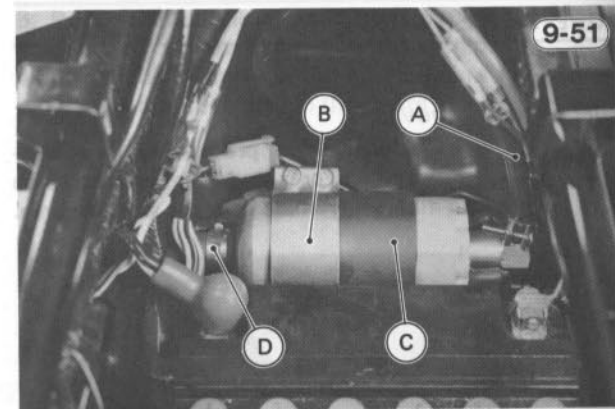

- A. Hose (to fuel distributing pipe)
- B. Holding Plate
- C. Fuel Pump
- D. Hose (from filter)

**Installation:**

**Fuel Pump Installation**

- NOTE:** 1. Observe the "Fuel Hose Installation Notes" (Pg. 9-34).  
 2. If a new fuel pump is installed, bleed the air in the fuel line before starting the engine as follows:

- Remove the air cleaner element.
- Turn on the ignition switch
- Push the air flap open in the air flow meter from the air cleaner side to operate the fuel pump. Continue for about 30 seconds.
- Turn off the switch.
- Install the air cleaner element.

## PRESSURE REGULATOR

### Removal:

#### Pressure Regulator Removal

**NOTE:** 1. The pressure regulator is installed under the throttle valves.

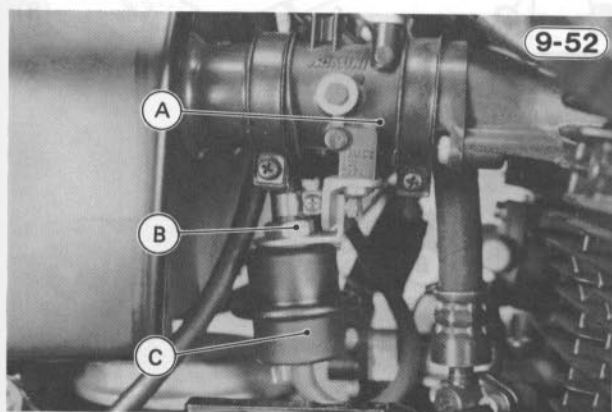

A. Throttle Valves      C. Pressure Regulator  
B. Mounting Nut

### Installation:

#### Pressure Regulator Installation

- NOTE:** 1. Observe the "Fuel Hose Installation Notes" (Pg. 9-39).
2. Refer to Fig. 9-53 for the hose connection and regulator installation directions.

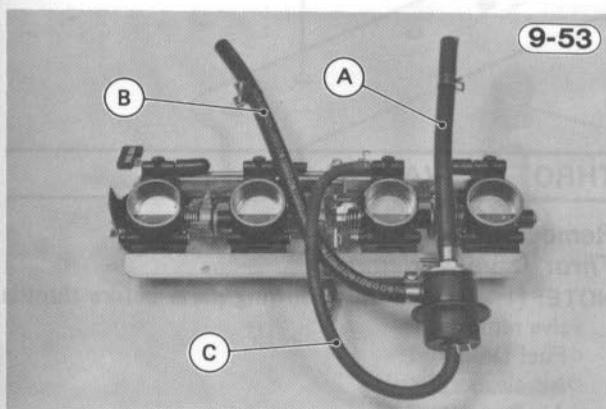

A. Return Fuel Hose (to tank)  
B. Fuel Hose (from distributing pipe)  
C. Vacuum Hose (from throttle valve)

## AIR CLEANER HOUSING AIR FLOW METER

### Removal:

#### Air Cleaner Housing Removal

**NOTE:** 1. Loosen the clamp before pulling off the air cleaner housing rearward.

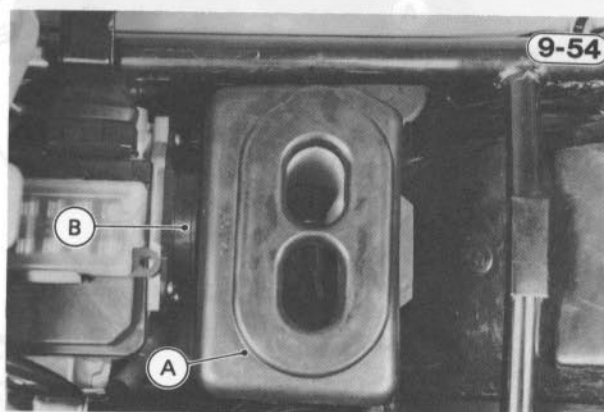

A. Air Cleaner Housing      B. Clamp

#### Air Flow Meter Removal

**WARNING** 1. Do not start the engine while the 7-pin connector on the air flow meter is disconnected. This could damage the control unit.

**NOTE:** 1. Lubricate the mating surfaces between the air flow meter and the surge tank with liquid soap to help air flow meter removal, and pull the air flow meter off rearward.

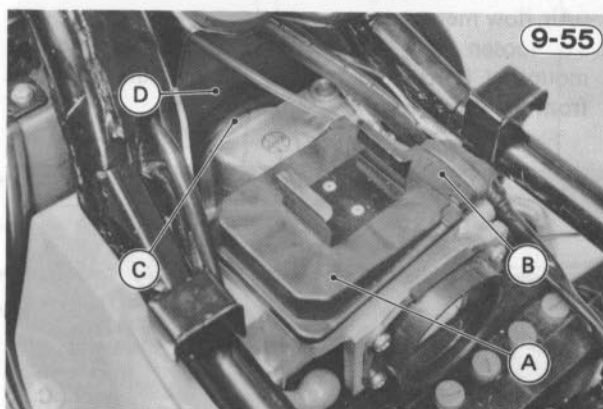

A. Air Flow Meter      C. Apply liquid soap.  
B. 7-pin Connector      D. Surge Tank

### Installation:

#### Air Flow Meter Installation

**NOTE:** 1. Clean off any dirt on the air passage wall and air flap with a piece of clean, dry cloth.

#### Air Cleaner Housing Installation

**NOTE:** 1. US model: Check to see the nozzle is fitted in the air hose fitting on the air cleaner housing, and connect the air hose to the fitting.

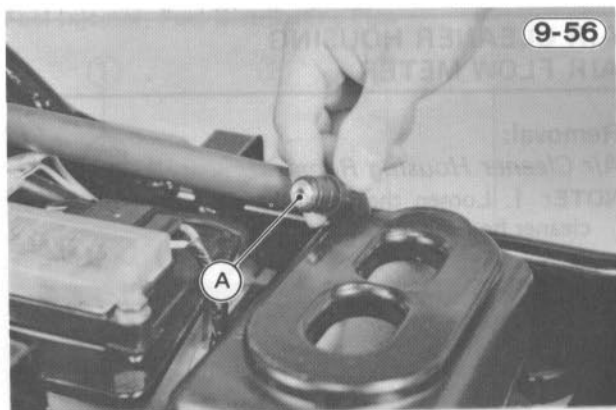

9-56

A. Nozzle (US model only)

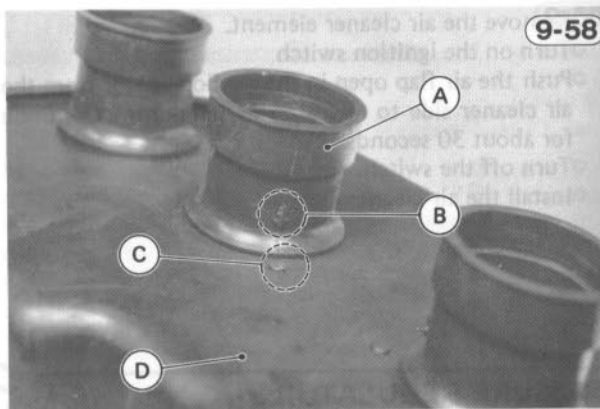

9-58

A. Duct  
B. Arrow  
C. Dot  
D. Surge Tank

2. Be sure to connect the breather hose to the breather cover, and install the clip.

## SURGE TANK

### Removal:

#### Surge Tank Removal

**NOTE:** 1. Remove the following parts before surge tank removal.

- Air cleaner housing
- Air flow meter

2. To loosen the #3 duct clamp, loosen the two mounting bolts, and remove the pressure regulator from the throttle valve assembly.

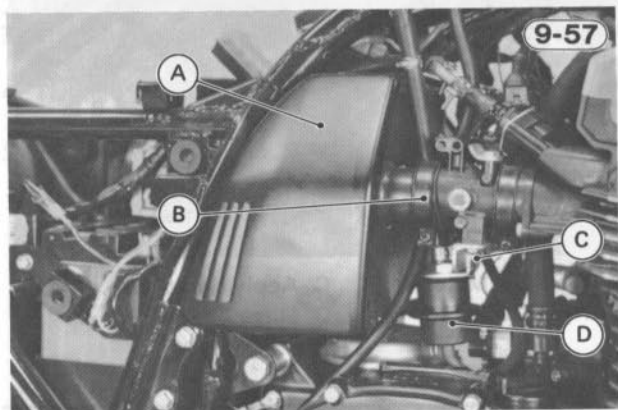

9-57

A. Surge Tank  
B. Duct Clamp  
C. Mounting Bolts  
D. Pressure Regulator

### Installation:

#### Surge Tank Installation

**NOTE:** 1. Check to see the arrow on the duct points at the dot on the surge tank.

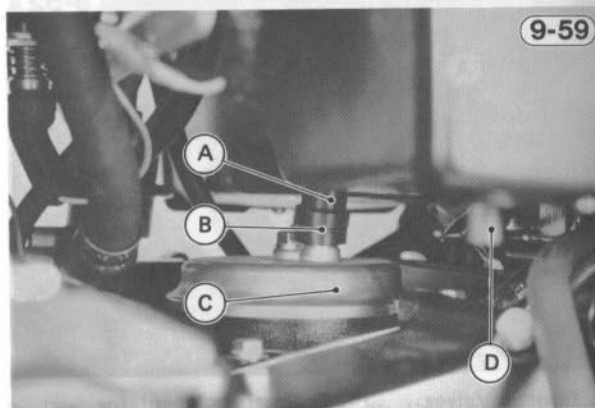

9-59

A. Breather Hose  
B. Clip  
C. Breather Cover  
D. Drain Plug

3. Check to see the drain plug is installed at the bottom of the surge tank.

## THROTTLE VALVES

### Removal:

#### Throttle Valve Removal

**NOTE:** 1. Remove the following parts before throttle valve removal.

- Fuel tank
- Air cleaner housing
- Air flow meter
- Throttle valve switch
- Surge tank
- Pressure regulator

Throttle Valves

9-60

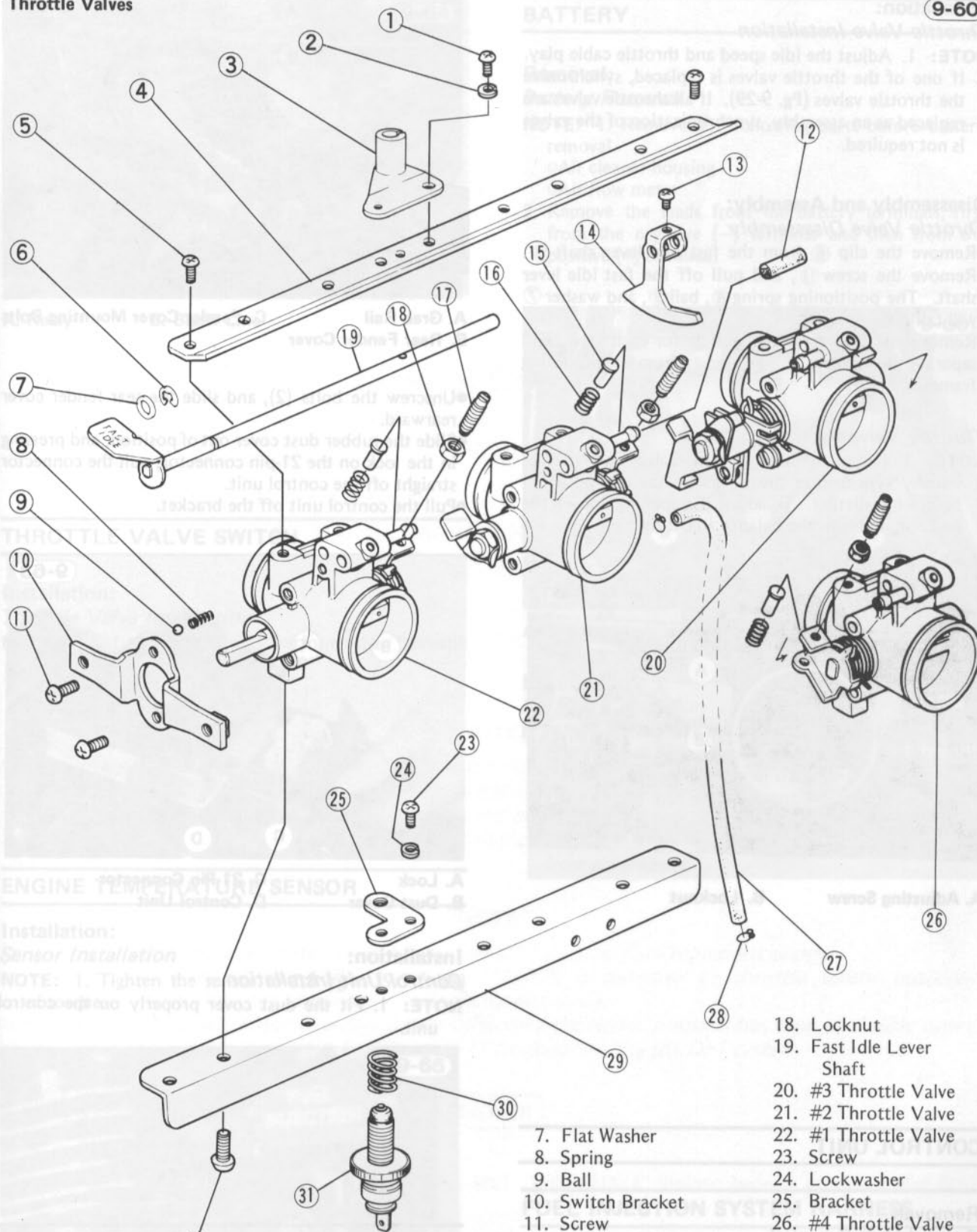

Installation:

Sensor Installation:

NOTE: 1. Tighten the locknut with the right-hand motion. 2. Adjust the idle speed and throttle cable play.

BATTERY

NOTE: 1. Adjust the idle speed and throttle cable play. 2. If one of the throttle valves (1, 2, 3) is not required, it is not required.

- 1. Screw
- 2. Lockwasher
- 3. Cable Bracket
- 4. Mounting Frame
- 5. Screw
- 6. Circlip

- 7. Flat Washer
- 8. Spring
- 9. Ball
- 10. Switch Bracket
- 11. Screw
- 12. Rubber Cap
- 13. Screw
- 14. Fast Idle Cam
- 15. Pin
- 16. Spring
- 17. Balance Adjusting Screw
- 18. Locknut
- 19. Fast Idle Lever Shaft
- 20. #3 Throttle Valve
- 21. #2 Throttle Valve
- 22. #1 Throttle Valve
- 23. Screw
- 24. Lockwasher
- 25. Bracket
- 26. #4 Throttle Valve
- 27. Vacuum Hose
- 28. Clamp
- 29. Mounting Frame
- 30. Spring
- 31. Idle Adjusting Screw & Idle Switch
- 32. Screw

A. Engine Temperature Sensor

**Installation:****Throttle Valve Installation**

- NOTE:** 1. Adjust the idle speed and throttle cable play.  
2. If one of the throttle valves is replaced, synchronize the throttle valves (Pg. 9-29). If all throttle valves are replaced as an assembly, synchronization of the valves is not required.

**Disassembly and Assembly:****Throttle Valve Disassembly**

- Remove the clip (6) from the fast idle lever shaft (19).
- Remove the screw (13), and pull off the fast idle lever shaft. The positioning spring (8), ball (9), and washer (7) will fall off.
- Remove the four screws (5) and (32) for each valve, and separate the valves (20, 21, 22), and (26) from the mounting frames (4) and (29).

**Throttle Valve Assembly**

- NOTE:** 1. If one of the throttle valves is replaced, visually synchronize the valves (in the idle position) before installation. To adjust the opening, loosen the locknut, and turn the balance adjusting screw.

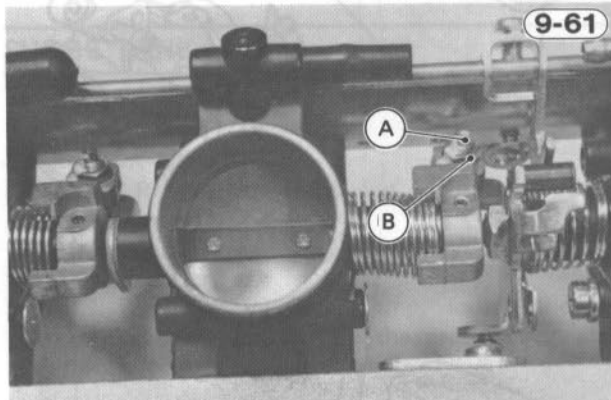

A. Adjusting Screw      B. Locknut

**CONTROL UNIT****Removal:****Control Unit Removal**

- Turn off the ignition switch, and disconnect the white/red fuel injection system lead from the battery positive side (Pg. 9-3).
- Remove the seat.
- Remove the bolts (2), loosen the upper rear shock absorber nuts (2), and remove the grab rail.

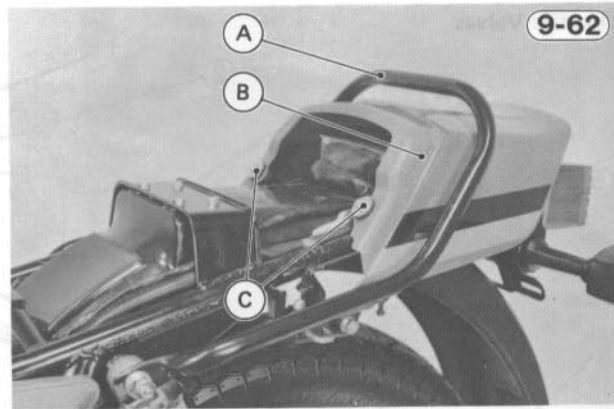

A. Grab Rail      C. Fender Cover Mounting Bolts  
B. Rear Fender Cover

- Unscrew the bolts (2), and slide the rear fender cover rearward.
- Slide the rubber dust cover out of position, and pressing in the lock on the 21-pin connector, pull the connector straight off the control unit.
- Pull the control unit off the bracket.

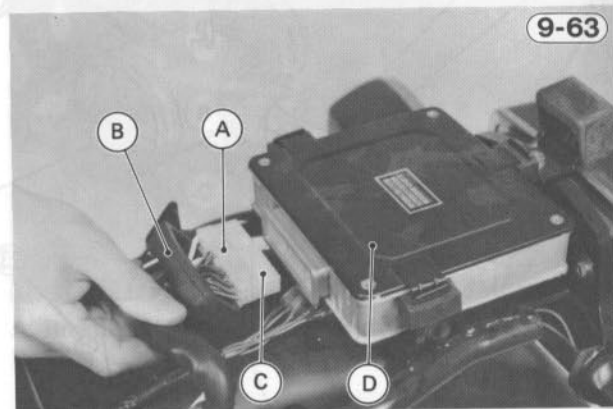

A. Lock      C. 21-Pin Connector  
B. Dust Cover      D. Control Unit

**Installation:****Control Unit Installation**

- NOTE:** 1. Fit the dust cover properly on the control unit.

**RELAY****Installation:****Relay Installation**

- NOTE:** 1. Install the black connector on the marking side (black line).



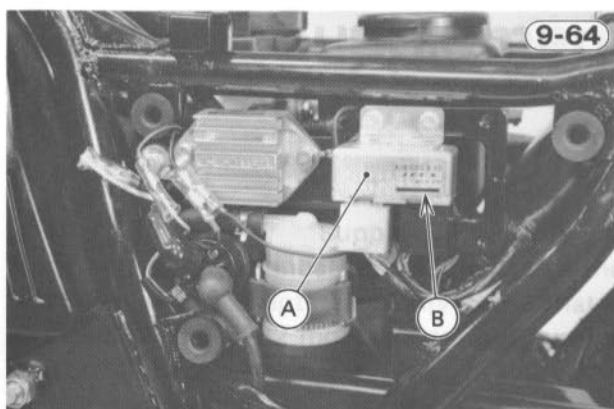

A. Relay      B. Black Line

## BATTERY

### Removal:

#### Battery Removal

**NOTE:** 1. Remove the following parts before battery removal.

- Air cleaner housing
- Air flow meter

2. Remove the leads from the battery terminals, first from the negative (–) terminal and then from the positive (+) terminal.

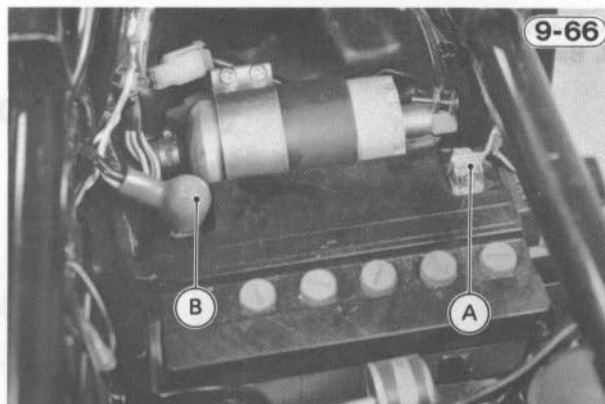

A. Negative (–) Terminal      B. Positive (+) Terminal

### Installation:

#### Battery Installation

**NOTE:** 1. Make sure the battery vent hose is kept away from the chain and exhaust system. Battery electrolyte can corrode and dangerously weaken the chain. Do not let the vent hose become folded, pinched, or melted by the exhaust system. An unvented battery will not keep a charge and it may crack from gas pressure.

## THROTTLE VALVE SWITCH

### Installation:

#### Throttle Valve Installation

**NOTE:** 1. After installation, perform the "throttle valve switch inspection" (Pg. 9-29).

## ENGINE TEMPERATURE SENSOR

### Installation:

#### Sensor Installation

**NOTE:** 1. Tighten the sensor to 1.3 kg-m (9.5 ft-lbs) of torque.

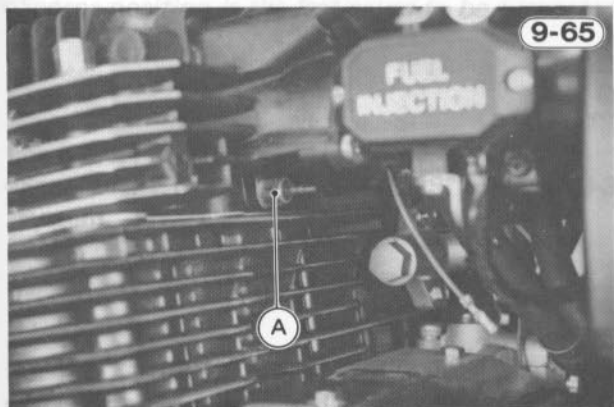

A. Engine Temperature Sensor

## FUEL INJECTION SYSTEM HARNESS

### Installation:

#### Harness Installation

**NOTE:** 1. Be sure to connect the two fuel injection system leads (black/green and black/yellow) to the battery negative side, and black lead to the starter relay.

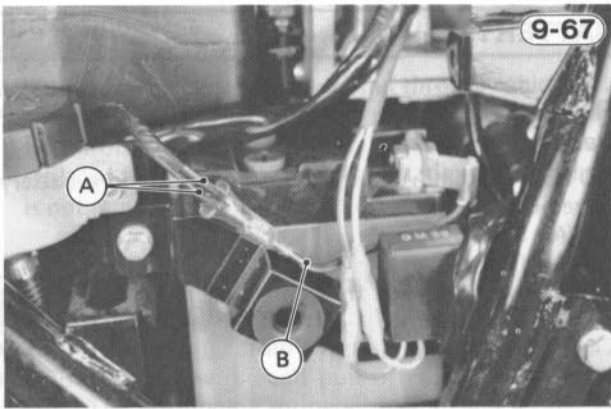

**A. Black/Green and Black/Yellow Leads**  
**B. Battery Negative (-) Lead**

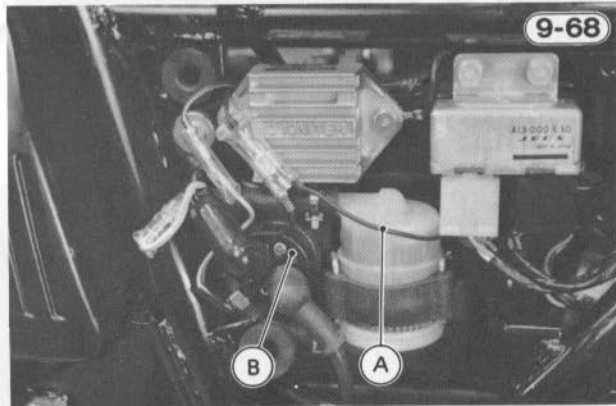

**A. Black Lead**      **B. Starter Relay**

**A. Adjusting Screw**      **B. Locknut**

**CONTROL UNIT**

**FUEL INJECTION SYSTEM HARNESS**

**Control Unit Removal**

Turn off the ignition switch and disconnect the red fuel injection lead from the control unit. Be sure to connect the two fuel injection system leads (black/green and black/yellow) to the correct terminals on the control unit. Disconnect the black lead from the control unit. Remove the two nuts (2) and the grab rail.



**A. Grab Rail**      **B. Rear Fender Cover**

Unscrew the bolts (2), and slide the rear fender cover rearward.  
 Slide the rubber dust cover out of position, and pressing in the lock on the 21-pin connector, pull the connector straight off the control unit.  
 Pull the control unit off the bracket.



**A. Lock**      **B. Dust Cover**

**Installation:**

Fit the dust cover properly on the control unit.



**A. Engine Temperature Sensor**

# Supplement – 1982 Model

KZ1000-J2.

This 10th chapter "Supplement – 1982 Model" is designed to be used in conjunction with the front part of this manual (up to the end of the 9th chapter). The maintenance and repair procedures described in this chapter are only those that are unique to the 1982 models. Complete and proper servicing of the 1982 models therefore requires mechanics to read both this chapter and the text in front of this chapter.

## Table of Contents

GENERAL INFORMATION .....	10-2
SCHEDULED MAINTENANCE .....	10-16
NON-SCHEDULED MAINTENANCE—ENGINE .....	10-19
NON-SCHEDULED MAINTENANCE—ELECTRICAL .....	10-39
DISASSEMBLY .....	10-51
KZ/Z1000-R1 SERVICE INFORMATION .....	10-57

### "NOTE"

*High Altitude Performance Adjustment Information (US Models):*

- To improve the EMISSION CONTROL PERFORMANCE of vehicles operated above 4,000 feet, an Environmental Protection Agency (EPA) approved modification may be required for some models. However, any kind of modification is not necessary for the 1982 model KZ1000J, K, and M, and KZ1100B.

### "NOTE"

*Important throttle sensor information for Kawasaki DFI (Digital Fuel Injection) system:*

- Engine performance of the 1982 model KZ/Z1100B is sensitive to throttle sensor position.
- The throttle sensor does not require any periodic maintenance.
- Do not alter or adjust sensor position unless otherwise the sensor position has been obviously upset.
- Sensor position is the last cause to be suspected in troubleshooting the DFI system.

### CAUTION

For KZ/Z1100B:

- See "SAFETY INSTRUCTIONS" on Pg. 9-3 and "WARNING" below before servicing the DFI system.

### WARNING

For KZ/Z1100B:

- When any fuel hose is disconnected, do not turn on the ignition switch. The fuel pump will operate and fuel will spout from the fuel hose if you turn on the switch while the hose is disconnected.

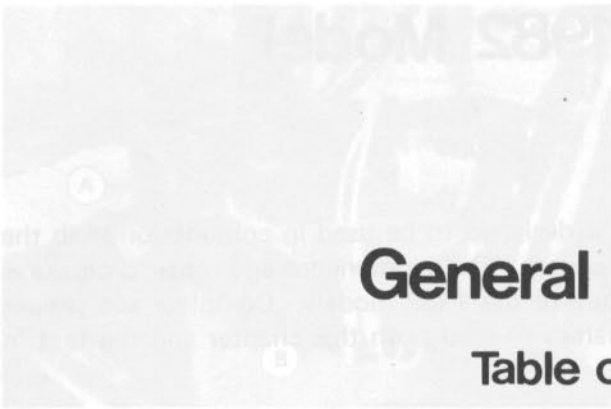

A. Black/Green and Black/Yellow Leads  
B. Battery Negative (-) Lead

# General Information

## Table of Contents

MODEL IDENTIFICATION .....	10-3
SPECIFICATIONS .....	10-5
SERVICE DATA .....	10-7
TORQUE AND LOCKING AGENT .....	10-9
SPECIAL TOOLS .....	10-10
LOCATION OF DFI SYSTEM PARTS (KZ/Z1100B) .....	10-11
WIRING DIAGRAMS .....	10-12

High Altitude Performance Adjustment Information (US Models):  
To improve the EMISSION CONTROL PERFORMANCE of vehicles operated above 4,000 feet, an Environmental Protection Agency (EPA) approved modification may be required for some models. However, any kind of modification is not necessary for the 1982 model KZ1000, K, and M, and KZ1100B.

**"NOTE"**

Important throttle sensor information for Kawasaki DFI (Digital Fuel Injection) system:  
Engine performance of the 1982 model KZ/Z1100B is sensitive to throttle sensor position. The throttle sensor does not require any periodic maintenance. Do not alter or adjust sensor position unless otherwise the sensor position has been obviously upset. Sensor position is the last cause to be suspected in troubleshooting the DFI system.

**CAUTION**

For KZ/Z1100B:  
See "SAFETY INSTRUCTIONS" on Pg. B-3 and "WARNING" below before servicing the DFI system.

**WARNING**

For KZ/Z1100B:  
When any fuel hose is disconnected, do not turn on the ignition switch. The fuel pump will operate and fuel will squirt from the fuel hose if you turn on the switch while the hose is disconnected.

MODEL IDENTIFICATION

KZ1000-J2: **8-01**

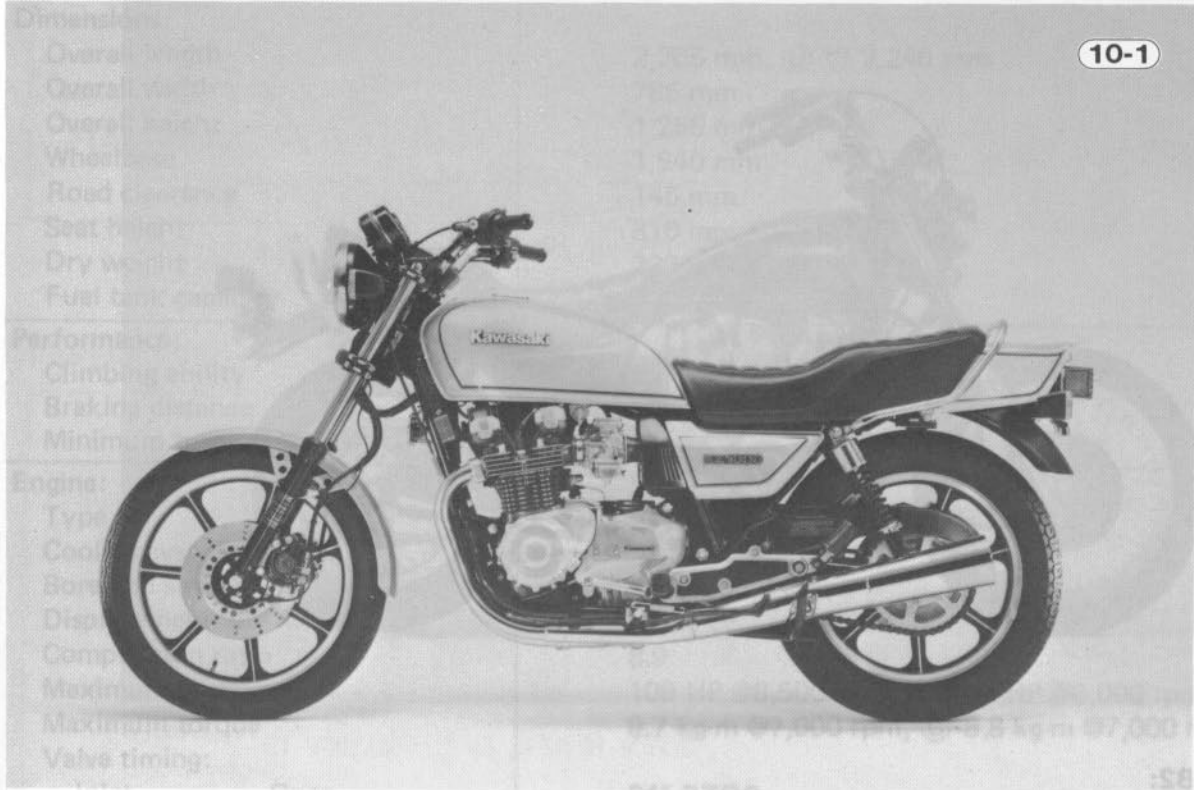

10-1

Z1000-K2: **4-01**



10-2

Ⓘ : US model    Ⓢ : Canadian model  
 Ⓙ : West German, Swiss, and Swedish models

(Continued on next page.)

10-4

KZ1000-M2:



KZ1100-B2:

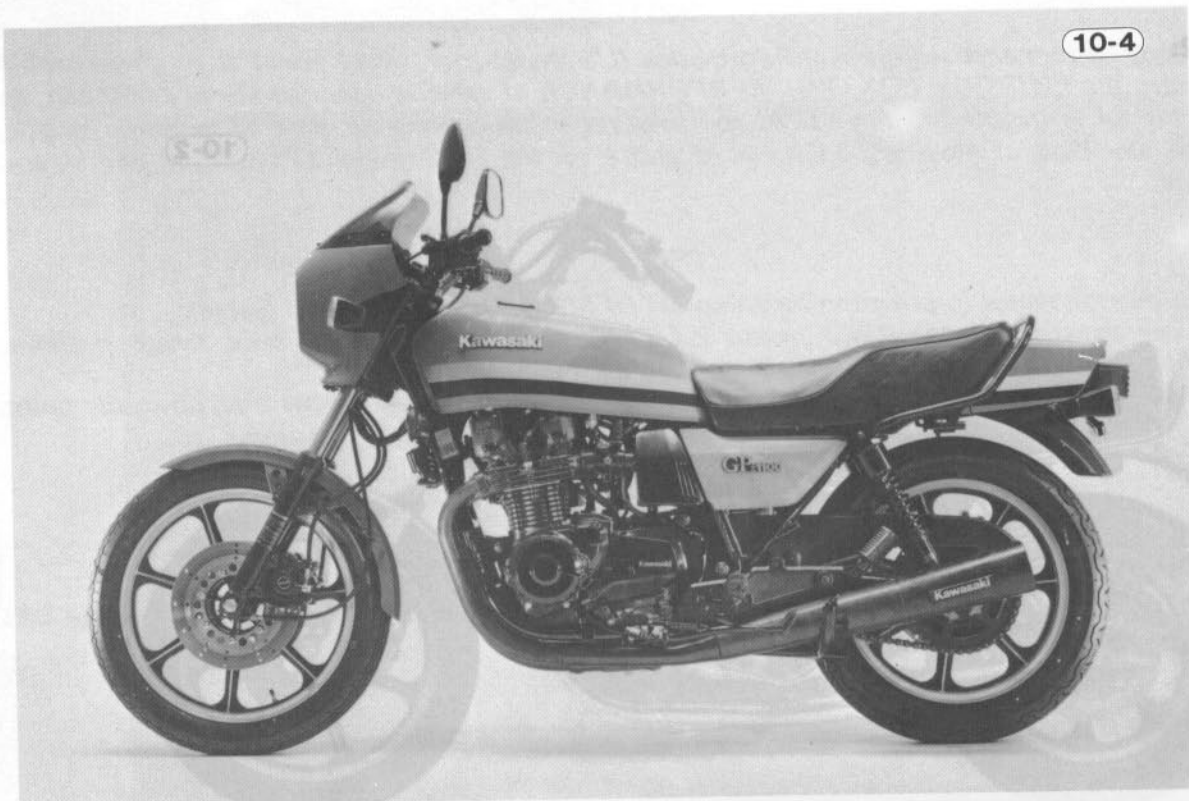

## SPECIFICATIONS

### KZ/Z1100B Specifications:

Items		
<b>Dimensions:</b>		
Overall length		2,265 mm, (U) (C) 2,240 mm
Overall width		785 mm
Overall height		1,255 mm
Wheelbase		1,540 mm
Road clearance		145 mm
Seat height		810 mm
Dry weight		236 kg
Fuel tank capacity		21.4 liters
<b>Performance:</b>		
Climbing ability		30°
Braking distance		12.5 m from 50 kph
Minimum turning radius		2.6 m
<b>Engine:</b>		
Type		4-stroke, DOHC, 4-cylinder
Cooling system		Air cooled
Bore and stroke		72.5 x 66.0 mm
Displacement		1,089 cc
Compression ratio		8.9
Maximum horsepower		109 HP @8,500 rpm, (G) 100 HP @8,000 rpm
Maximum torque		9.7 kg-m @7,000 rpm, (G) 8.8 kg-m @7,000 rpm
Valve timing:		
Inlet	Open	34° BTDC
	Close	74° ABDC
	Duration	288°
Exhaust	Open	72° BBDC
	Close	36° ATDC
	Duration	288°
Carburetion system		DFI (Digital Fuel Injection)
Cylinder numbering method		Left to right, 1-2-3-4
Firing order		1-2-4-3
Lubrication system		Forced lubrication (Wet sump with oil cooler)
Engine oil:		
Grade		SE class
Viscosity		SAE 10W40, 10W50, 20W40, or 20W50
Capacity		
Engine		3.7 liters
Oil cooler and hoses		0.2 liters
Starting system		Electric starter
Ignition system		Battery and coil (Transistorized)
Timing advance		Mechanically advanced
Ignition timing		From 10° BTDC @1,000 rpm to 40° BTDC @3,400 rpm
Spark plugs		NGK B8ES or ND W24ES-U (C), (E) NGK BR8ES or ND W24ESR-U

(U) : US model

(E) : European model (except Italian model)

(C) : Canadian model

(G) : West German, Swiss, and Swedish models

(Continued on next page.)

## KZ/Z1100B Specifications (Cont.):

Items	
<b>Drive Train:</b>	
Primary reduction system:	
Type	Gear
Reduction ratio	1.732 (97/56)
Clutch type	Wet multi disc
Transmission:	
Type	5-speed, constant mesh, return shift
Gear ratios	
1st	2.642 (37/14)
2nd	1.833 (33/18)
3rd	1.428 (30/21)
4th	1.173 (27/23)
5th	1.040 (26/25)
Final drive system:	
Type	Chain drive
Reduction ratio	2.666 (40/15), Ⓚ Ⓞ 2.800 (42/15)
Overall drive ratio	4.803 @Top gear, Ⓚ Ⓞ 5.043
<b>Frame:</b>	
Type	Tubular, double cradle
Castor (rake angle)	29°
Trail	120 mm
Front tire:	
Type	Tubeless
Size	3.25V-19 4PR, Ⓚ Ⓞ 100/90V 19
Rear tire:	
Type	Tubeless
Size	4.25V-18 4PR, Ⓚ Ⓞ 120/90V 18
Front suspension:	
Type	Telescopic fork (Pneumatic)
Wheel travel	145 mm
Rear suspension:	
Type	Swing arm
Wheel travel	104 mm
Brake type:	
Front	Dual disc brake
Rear	Single disc brake
<b>Electrical Equipment:</b>	
Alternator:	
Type	Three-phase AC
Rated output	20 amp. @8,000 rpm, 14V
Voltage regulator	Short-circuit type
Battery	12V 16AH
Headlight:	
Type	Semi-sealed
Bulb	12V 60/55W (Quartz-halogen)
Tail/brake light	12V 5/21W x 2, Ⓚ Ⓞ Ⓢ 12V 8/27W x 2

Ⓚ : US model

Ⓞ : Canadian model

Ⓢ : South African model

Specifications subject to change without notice, and may not apply to every country.

(Continued on next page)



## SERVICE DATA

Table 10-1 Rear Shock Absorber (Cont.)  
Damping Force (KZ/Z1100B)

### Engine:

Item	Standard	Service Limit	See Page
<b>Camshafts:</b>			
Cam Height:			4-2
KZ/Z1100B: In. & Ex.	36.936 – 37.064 mm	36.84 mm	3-5

### Chassis:

Item	Standard	Service Limit	See Page
<b>Wheels:</b>			
Tire Tread Depth (Z1000J, KZ/Z1100B):			
Front	4.2 mm	See Table 2-14	2-21
Rear	7.4 mm		
Standard Tire: Z1000J/1100B (Other than US, Canada):			
Front	3.25V 19 4PR TUBELESS DUNLOP K300MA or K300M	---	---
Rear	4.25V 18 4PR TUBELESS DUNLOP M300	---	---
KZ1100B (US, Canada): Front	100/90V 19 TUBELESS	---	---
Rear	DUNLOP K300MA 120/90V 18 TUBELESS DUNLOP K300	---	---
Tire Air Pressure: Z1100B (Other than US, Canada):			
Front	2.00 kg/cm <sup>2</sup> (196 kPa, 28 psi) when riding under less than 150 kg load and speed of less than 210 kph. 2.25 kg/cm <sup>2</sup> (221 kPa, 32 psi) when riding under 150 – 180 kg load and speed of less than 210 kph.	---	---
Engine drain plug	2.25 kg/cm <sup>2</sup> (221 kPa, 32 psi) when riding faster than 210 kph.		
Handlebar clamp bolts	2.25 kg/cm <sup>2</sup> (221 kPa, 32 psi) when riding faster than 210 kph.		
Handlebar holder mounting bolts	2.25 kg/cm <sup>2</sup> (221 kPa, 32 psi) when riding faster than 210 kph.		

## Chassis (Cont.): Specifications (Cont.):

SERVICE DATA

Item	Standard	Service Limit	See Page
Rear	2.25 kg/cm <sup>2</sup> (221 kPa, 32 psi) when riding under less than 150 kg load and speed of less than 210 kph.	---	---
	2.50 kg/cm <sup>2</sup> (245 kPa, 36 psi) when riding under 150 – 180 kg load and speed of less than 210 kph.		
	2.90 kg/cm <sup>2</sup> (284 kPa, 41 psi) when riding faster than 210 kph.		
<b>Sprockets:</b>			
Rear Sprocket Diameter:			
40T (Other than US, Canada)	230.94 – 231.44 mm	230.6 mm	4-8
42T (US, Canada)	243.06 – 243.56 mm	242.8 mm	4-8
<b>Front Fork:</b>			
Oil Capacity (each fork):			
KZ/Z1000J	341 ± 4 cc (when changing oil: about 290 cc)	---	2-20
KZ/Z1000K, M	347 ± 4 cc (when changing oil: about 295 cc)	---	2-20
KZ/Z1100B	322 ± 4 cc (when changing oil: about 275 cc)	---	2-20
Fork Spring Free Length:			
KZ/Z1000K, M	602 mm	590 mm	4-14
KZ/Z1100B	532.5 mm	522 mm	4-14
Oil level:			
KZ/Z1000J	126 ± 2 mm	---	2-20
KZ/Z1000K, M	189 ± 2 mm	---	2-20
KZ/Z1100B	164 ± 2 mm	---	2-20
Air Pressure:			
KZ/Z1100B	0.45 – 0.55 kg/cm <sup>2</sup> (44 – 54 kPa, 6.4 – 7.8 psi)	---	4-14

## Electrical:

Item	Standard	Service Limit	See Page
<b>Electric Starter System:</b>			
Starter Motor:			
Brush Length	12.0 – 12.5 mm	6 mm	5-17
Brush Spring Tension	340 – 460 grams	---	5-18

**Front Fork Spring Force (per one fork leg unit) 10-5**

(1) KZ1100B (US and Canadian Models): Same as 1981 Z1100B European and general export models. See Fig. 9-6 on Pg. 9-9.

(2) KZ/Z1000K and M

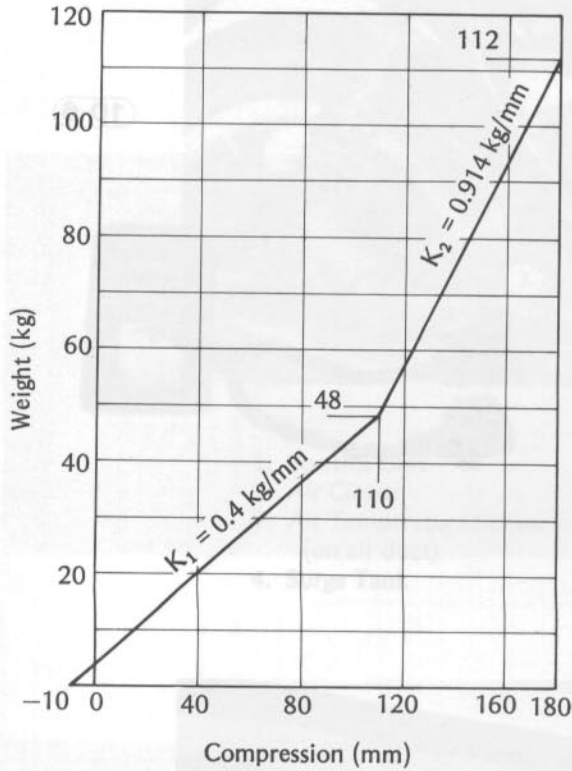

**Table 10-1 Rear Shock Absorber Damping Force (KZ/Z1100B)**

Adjuster Position	Damping Force kg	
	Extension Stroke @0.3 m/s	Compression Stroke @1.0 m/s
1	45.6 – 68.4	32 – 48
2	56.8 – 85.2	
3	67.2 – 100.8	
4	78.4 – 117.6	
5	86.4 – 129.6	

**TORQUE AND LOCKING AGENT**

Part	Dia x Pitch mm	Quantity	Torque		Remark	See Page
			kg-m	ft-lbs		
Engine drain plug	12 x 1.5	1	3.0	22	—	2-4
Handlebar clamp bolts	8 x 1.25	2	2.5	18.0	—	10-56
Handlebar holder mounting bolts	34 x 1.5	2	7.5	54	—	10-57
IC igniter mounting bolts	6 x 1.0	2	0.65	56 in-lbs	—	7-26

**SPECIAL TOOLS**

Ref. No.	Part No.	Description	Quantity
1	57001-351	Balance Adjuster	1
2	57001-1003	Throttle Sensor Position Checker	1
3	57001-1152	Vacuum Gauge	1
4	57001-1153	Valve Lifter Holder Set	1 set

10-6

Sprockets:

①

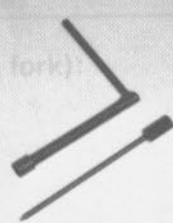

Oil Capacity (each fork):  
KZ/Z1000J  
KZ/Z1000K, M  
KZ/Z1100B

Fork Spring Free Length:  
KZ/Z1000K, M  
KZ/Z1100B

Oil level:  
KZ/Z1000J  
KZ/Z1000K, M  
KZ/Z1100B

②



③

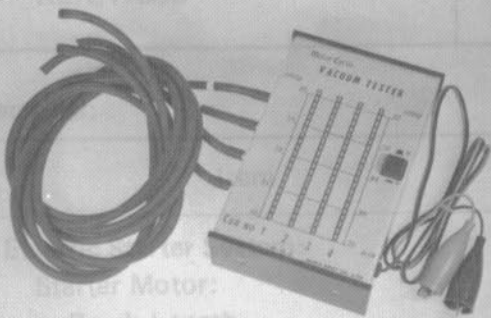

④

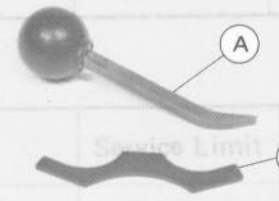

A. Lever  
B. Holder

See Page	Remark	Torque		Quantity	Dia x Pitch mm	Part
		kg-m	ft-lbs			
2-4	-	3.0	22	1	12 x 1.5	Engine drain plug
10-66	-	2.5	18.0	2	8 x 1.25	Handlebar clamp bolts
10-67	-	7.5	54	2	34 x 1.5	Handlebar holder mounting bolts
7-58	-	0.68	68 in-lbs	2	8 x 1.0	IC igniter mounting bolts

## LOCATION OF DFI SYSTEM PARTS (KZ/Z1100B)

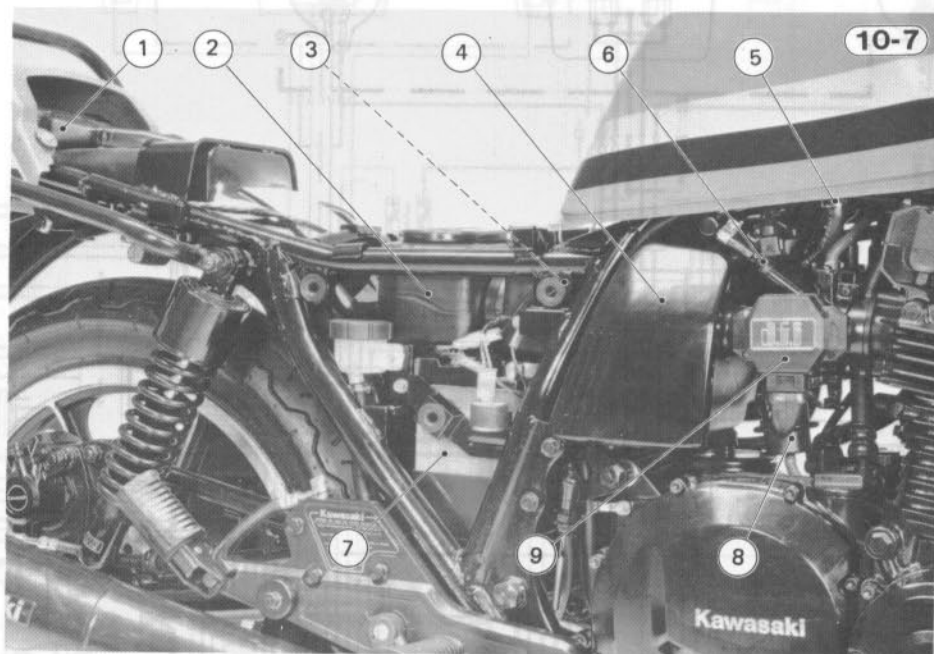

1. Control Unit
2. Air Cleaner
3. Air Temperature Sensor  
(on air duct)
4. Surge Tank

5. Check Valve
6. Fuel Injectors x 4
7. Battery
8. Pressure Regulator
9. Throttle Sensor

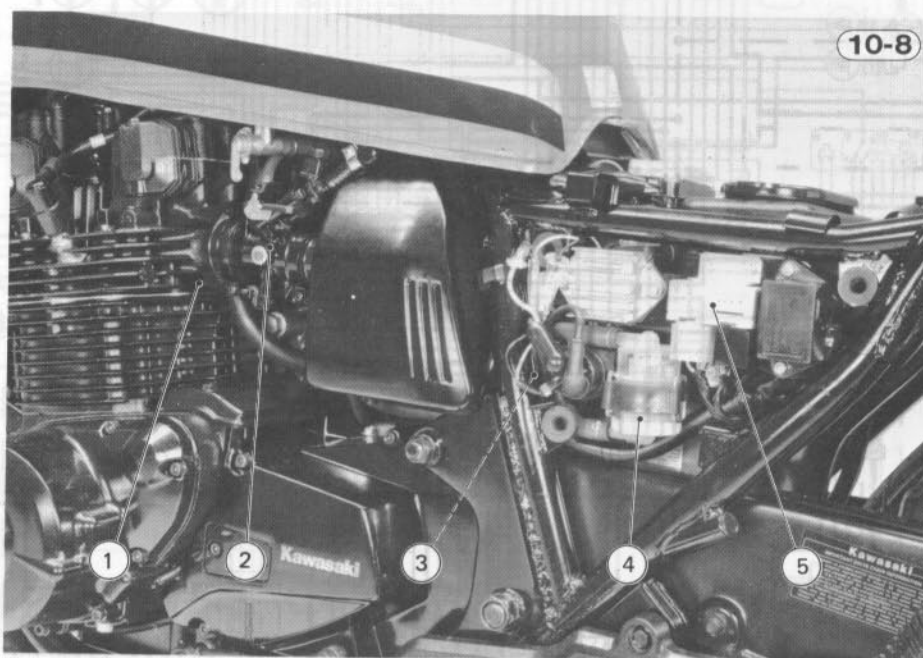

1. Engine Temperature Sensor
2. Throttle Valve Assembly
3. Fuel Pump (under air duct)

4. Fuel Filter
5. Main/Pump Relay

**KZ1000-M2 Wiring Diagram  
(US and Canadian Models)**

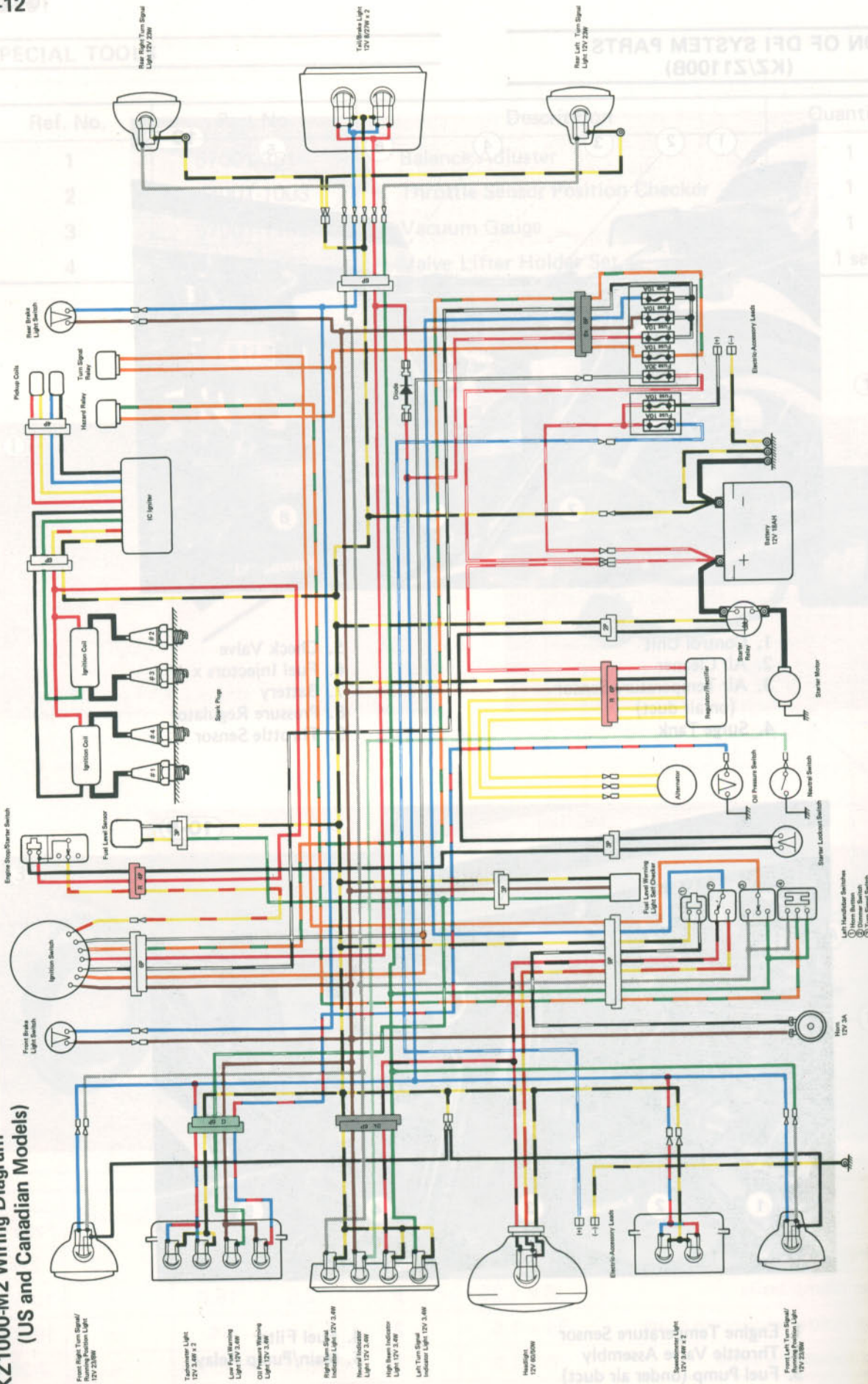

- Front Right Turn Signal/  
Horn Illumination Light  
12V 25/25W
- Tail/Brake Light  
12V 3.0W x 2
- Low Fuel Warning  
Light 12V 3.0W
- Oil Pressure Warning  
Light 12V 3.0W
- Right Turn Signal  
Indicator Light 12V 3.0W
- Neutral Indicator  
Light 12V 3.0W
- High Beam Indicator  
Light 12V 3.0W
- Left Turn Signal  
Indicator Light 12V 3.0W
- Headlight  
12V 60/50W
- Starter Motor  
12V 2.0W x 2
- Front Left Turn Signal/  
Horn Illumination Light  
12V 25/25W

Color Code	Color
BL	Black
BR	Brown
BU	Blue
GY	Gray
LG	Light Green
OR	Orange
PK	Pink
RD	Red
WH	White
YL	Yellow

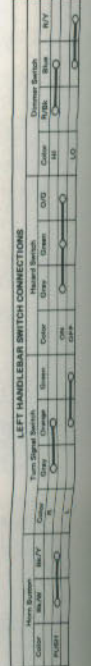
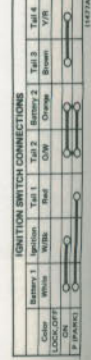

- Left Handlebar Switches**
- ① Horn Switch
  - ② Turn Signal Switch
  - ③ Kill Switch
  - ④ Ignition Switch



# Z1100-B2 Wiring Diagram (European and General Export Models)

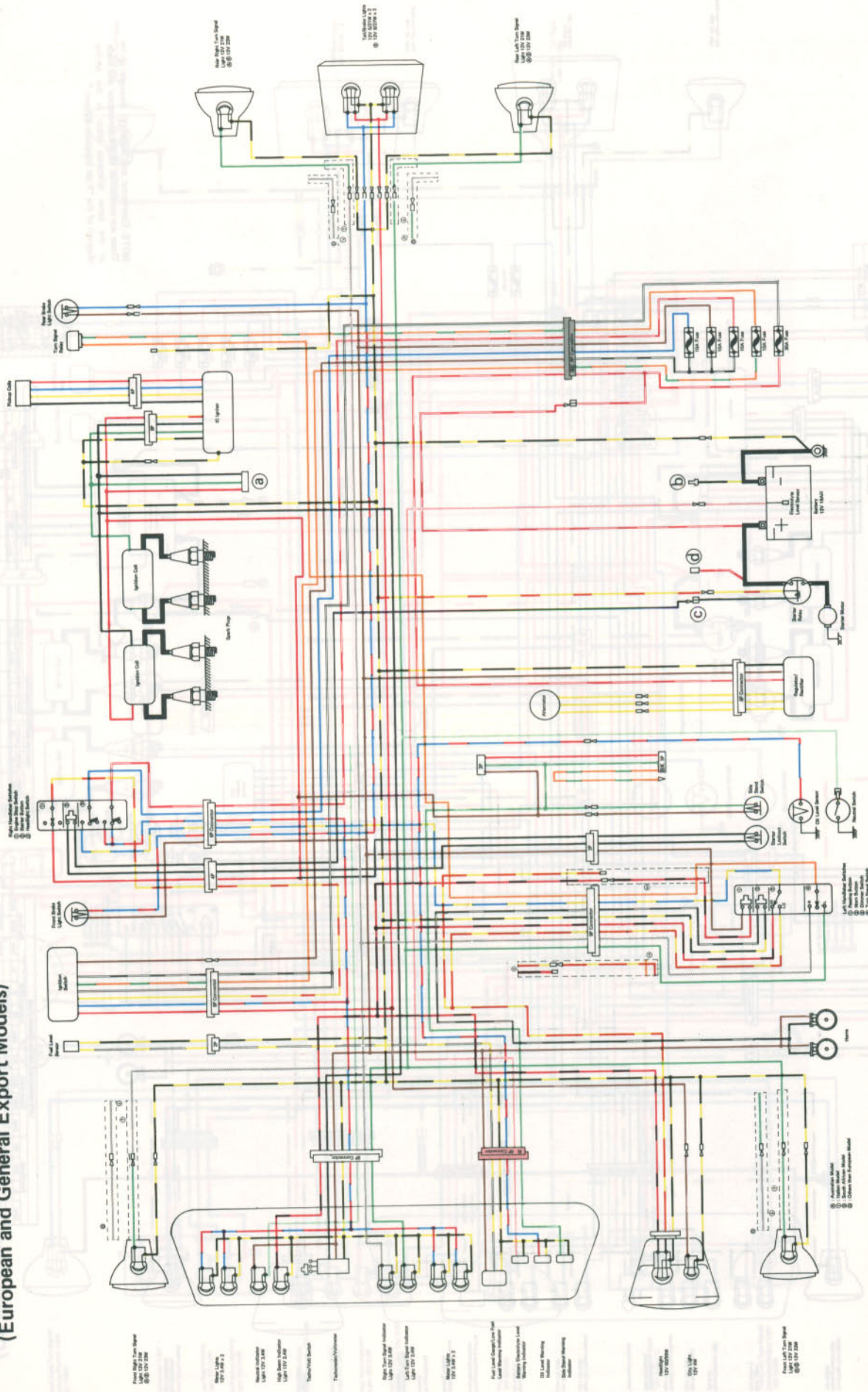

**Note:** Connector and leads (a) through (d) These are connected to the connector and leads of the same reference letter in the wiring diagram of the "Fuel Injection System."

WIRE COLOR	WIRE NUMBER	WIRE FUNCTION
Red	1	Battery (+)
Blue	2	Battery (-)
Yellow	3	Headlight
Green	4	Horn
Black	5	Ground

WIRE COLOR	WIRE NUMBER	WIRE FUNCTION
Red	6	Ignition Switch
Blue	7	Ignition Coil
Yellow	8	Turn Signal
Green	9	Turn Signal
Black	10	Ground

WIRE COLOR	WIRE NUMBER	WIRE FUNCTION
Red	11	Headlight
Blue	12	Horn
Yellow	13	Turn Signal
Green	14	Turn Signal
Black	15	Ground

WIRE COLOR	WIRE NUMBER	WIRE FUNCTION
Red	16	Ignition Switch
Blue	17	Ignition Coil
Yellow	18	Turn Signal
Green	19	Turn Signal
Black	20	Ground



PERIODIC MAINTENANCE CHART (KZ/Z1100B)

The maintenance and adjustments for the 1982 model KZ/Z1100B must be done in accordance with this chart to keep the motorcycle in good running condition. The initial maintenance is vitally important and must not be neglected.

	FREQUENCY	ODOMETER READING*	See Page
Brake wear	Check	10,000 km	2-15
Brake fluid level - check	+	10,000 km	2-15
Brake fluid change		20,000 km	2-18
Brake light switch - check	+	10,000 km	2-18
Air Temperature Sensor		10,000 km	10-18
Idle speed - check	+	10,000 km	10-18
Throttle Sensor		10,000 km	10-18
Step - check	+	10,000 km	2-10
Front chain - check	+	10,000 km	10-18
Nuts, bolt fasteners - check	+	10,000 km	2-25
Spark plug - clean and gap	+	10,000 km	2-6
Valve clearance - check	+	10,000 km	2-6
Air suction valve (US model) - check	+	10,000 km	2-9
Air cleaner element - clean	+	10,000 km	9-15
Air cleaner element - replace		20,000 km	9-15
Tire tread wear - check	+	10,000 km	2-21
Engine oil change		10,000 km	9-15
Oil filter - replace		10,000 km	9-15
General lubrication - perform		10,000 km	10-18
Front fork oil change		10,000 km	10-8
Timing adjustment		10,000 km	2-5
Swing bearing - lubricate		10,000 km	2-23
Wheel bearing - lubricate		10,000 km	2-22
Spring stem bearings - lubricate		10,000 km	2-20
Master cylinder cup and dust seal - replace		10,000 km	2-17
Cylinder piston seal and dust seal - replace		10,000 km	2-17
Brake hose - replace		10,000 km	2-17
High pressure fuel hose - replace		10,000 km	2-17
Low pressure fuel hose - replace		10,000 km	2-17
Front chain - lubricate		10,000 km	2-15
Front chain slack - check	+	10,000 km	2-13

Fuel Injection System Wiring Diagram

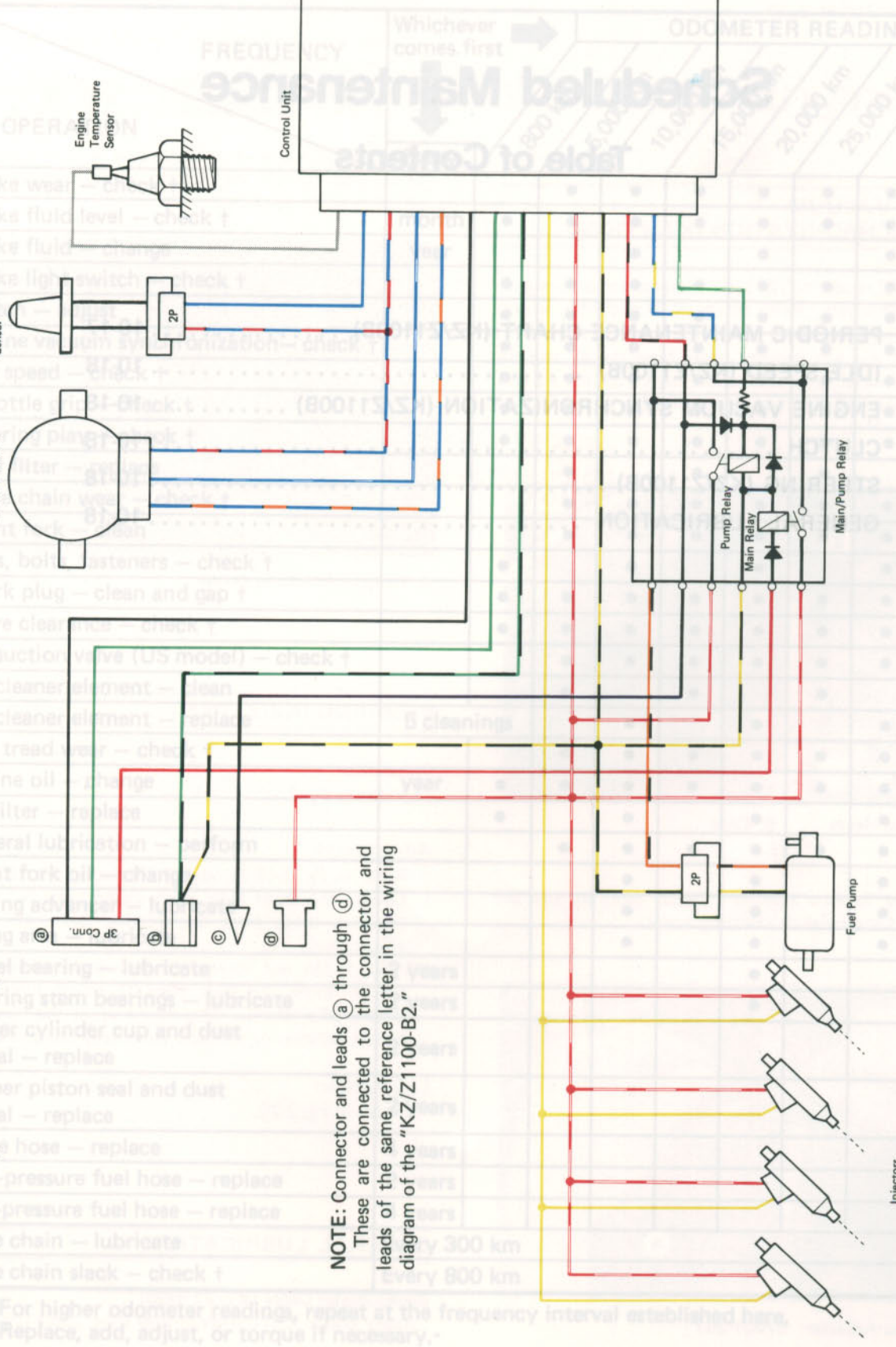

**NOTE:** Connector and leads (a) through (d) These are connected to the connector and leads of the same reference letter in the wiring diagram of the "KZ/Z1100-B2."

\* For higher odometer readings, repeat at the frequency interval established here.  
 + : Replace, add, adjust, or torque if necessary.

# Scheduled Maintenance

## Table of Contents

PERIODIC MAINTENANCE CHART (KZ/Z1100B) .....	10-17
IDLE SPEED (KZ/Z1100B) .....	10-18
ENGINE VACUUM SYNCHRONIZATION (KZ/Z1100B) .....	10-18
CLUTCH .....	10-18
STEERING (KZ/Z1100B) .....	10-18
GENERAL LUBRICATION .....	10-18

Z1100-52 Wiring Diagram  
(European and General Export Models)

определенный курс Z1100-52  
содержит информацию о том, как  
подключить провода к компонентам  
МОТОЦИКЛА и т.д.

Low Injection System Assembly Diagram

## PERIODIC MAINTENANCE CHART (KZ/Z1100B)

The maintenance and adjustments for the 1982 model KZ/Z1100B must be done in accordance with this chart to keep the motorcycle in good running condition. **The initial maintenance is vitally important and must not be neglected.**

OPERATION	FREQUENCY	Whichever comes first ↓	ODOMETER READING*							See Page
			800 km	5,000 km	10,000 km	15,000 km	20,000 km	25,000 km	30,000 km	
Brake wear – check †	Every		•	•	•	•	•	•	•	2-15
Brake fluid level – check †	month	•	•	•	•	•	•	•	•	2-15
Brake fluid – change	year			•		•		•		2-16
Brake light switch – check †		•	•	•	•	•	•	•	•	2-18
Clutch – adjust		•	•	•	•	•	•	•	•	10-18
Engine vacuum synchronization – check †		•	•	•	•	•	•	•	•	10-18
Idle speed – check †		•	•	•	•	•	•	•	•	10-18
Throttle grip – check †		•	•	•	•	•	•	•	•	2-10
Steering play – check †		•	•	•	•	•	•	•	•	10-18
Fuel filter – replace			•		•		•			9-17
Drive chain wear – check †			•	•	•	•	•	•	•	2-14
Front fork – clean			•	•	•	•	•	•	•	2-20
Nuts, bolts, fasteners – check †		•		•		•		•		2-28
Spark plug – clean and gap †		•	•	•	•	•	•	•	•	2-5
Valve clearance – check †		•	•	•	•	•	•	•	•	2-5
Air suction valve (US model) – check †			•	•	•	•	•	•	•	2-9
Air cleaner element – clean			•		•		•			9-15
Air cleaner element – replace	5 cleanings			•		•		•		9-15
Tire tread wear – check †			•	•	•	•	•	•	•	2-21
Engine oil – change	year	•	•	•	•	•	•	•	•	9-15
Oil filter – replace		•		•		•		•		9-15
General lubrication – perform			•	•	•	•	•	•	•	10-18
Front fork oil – change				•		•		•		10-8
Timing advancer – lubricate				•		•		•		2-5
Swing arm – lubricate				•		•		•		2-23
Wheel bearing – lubricate	2 years					•				2-22
Steering stem bearings – lubricate	2 years					•				2-20
Master cylinder cup and dust seal – replace	2 years									2-17
Caliper piston seal and dust seal – replace	2 years									2-17
Brake hose – replace	4 years									2-17
High-pressure fuel hose – replace	2 years									9-17
Low-pressure fuel hose – replace	4 years									9-17
Drive chain – lubricate	Every 300 km									2-15
Drive chain slack – check †	Every 800 km									2-13

\* : For higher odometer readings, repeat at the frequency interval established here.

† : Replace, add, adjust, or torque if necessary.

## IDLE SPEED (KZ/Z1100B)

Refer to Pg. 9-16, noting the following:

1. The 1982 model KZ/Z1100B has no idle switch on the idle adjusting screw.

## ENGINE VACUUM SYNCHRONIZATION (KZ/Z1100B)

The 1982 model KZ/Z1100B requires periodic engine vacuum inspection. Refer to Pgs. 9-29 and 9-30, noting the following exceptions.

1. Pull off the two vacuum hoses from the #1 and #4 throttle valves, and two rubber caps from the #2 and #3 valves, and connect a vacuum gauge to the fittings on the valves.

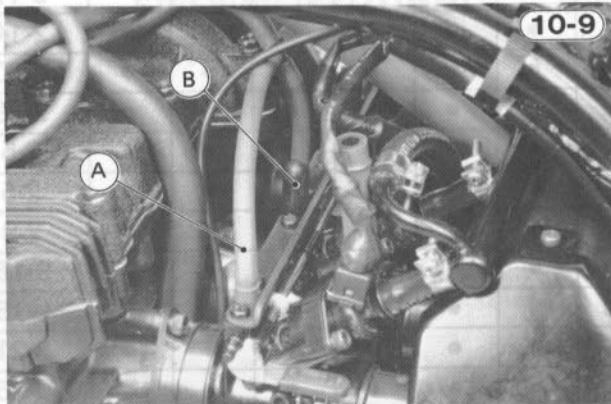

A. Vacuum Hoses B. Caps

2. Use the balance adjuster (special tool) to turn the locknut and balance adjusting screw.

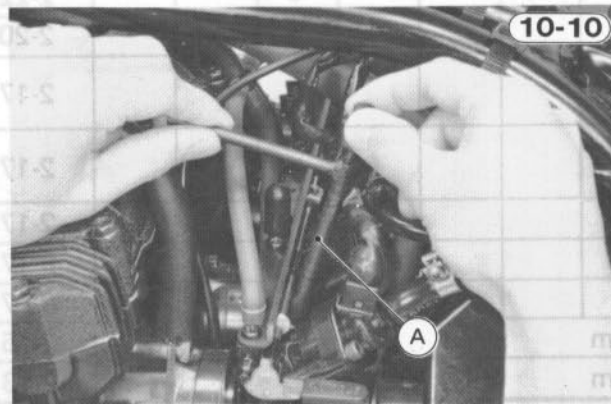

A. Balance Adjuster: 57001-351

## CLUTCH

The clutch release mechanism is changed from the ball-screw type to the ball-cam type.

Refer to Pgs. 2-12 and 2-13, noting the following exception:

1. Clutch release adjustment (see the lines 1 through 4 in the right column):
  - Loosen the locknut, and turn the clutch release adjusting screw **counterclockwise** until it becomes hard to turn.
  - Turn the adjusting screw **clockwise**  $\frac{1}{4}$  turn from that point, and tighten the locknut without changing the adjusting screw position.

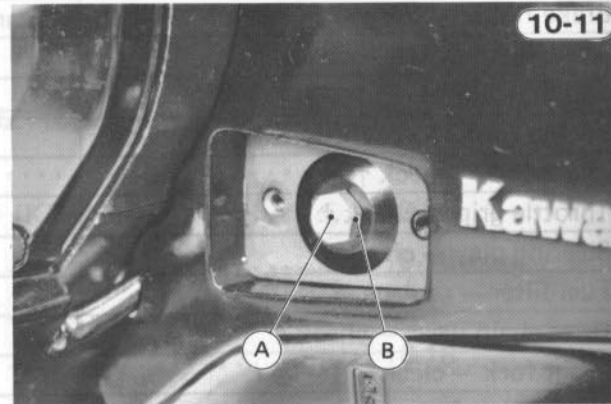

A. Release Adjusting Screw

B. Locknut

## STEERING (KZ/Z1100B)

### Inspection

Refer to Pg. 2-18.

### Adjustment

Refer to Pg. 2-18 through 2-20, noting the following:

1. Loosen the front fork lower clamp bolts (4) to free the fork tubes from the steering stem base during adjustment.
- NOTE:** 1. Do not loosen the fork upper clamp bolts (2) to allow the fork tubes to reseat themselves during adjustment. This could upset the handlebar holder installation or cause stem head distortion.

### Lubrication

Refer to Pg. 2-20.

## GENERAL LUBRICATION

### Speedometer Cable (KZ/Z1100B)

Apply grease to the speedometer inner cable (Pg. 2-27).

# Non-scheduled Maintenance – Engine

## Table of Contents

HIGH ALTITUDE PERFORMANCE ADJUSTMENT INFORMATION (US MODELS) .....	10-20
CYLINDER BLOCK, PISTONS (KZ/Z1100B) .....	10-20
ENGINE LUBRICATION SYSTEM (KZ/Z1100B) .....	10-20
DFI (DIGITAL FUEL INJECTION) SYSTEM (KZ/Z1100B) .....	10-20

1. Engine Temperature Sensor 2-Pin Connector
2. Ignition Signal 3-Pin Connector
3. Pickup Coil 4-Pin Connector between battery and fuel pump
4. Air Temperature Sensor 2-Pin Connector

**NOTE:** 1. If above all inspections prove good but the engine still operates poorly, the throttle may be caused by the engine linkage. Overhaul the engine. Especially inspect the gears and linkers for wear and adjust. Piston rings, valves and valve seats for any irregularities. Remove the carbon from the piston heads, rings, and cylinder head, and valves.

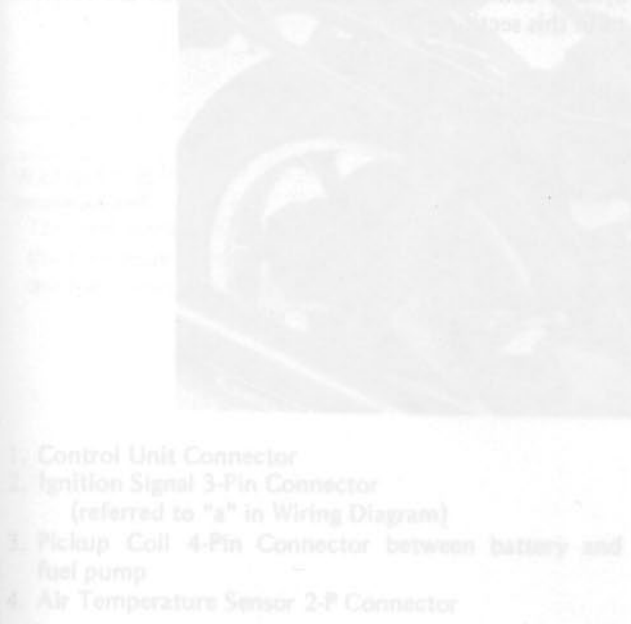

### HIGH ALTITUDE PERFORMANCE ADJUSTMENT INFORMATION (US MODELS)

To improve the performance of vehicles operated above 4000 feet, an Environmental Protection Agency (EPA) modification may be required for some models.

1. Measure the air filter for a carbon build-up. To stop fuel test, disconnect the battery system from the engine.

2. Check the air filter for a carbon build-up. To stop fuel test, disconnect the battery system from the engine.

3. Check the air filter for a carbon build-up. To stop fuel test, disconnect the battery system from the engine.

4. Check the air filter for a carbon build-up. To stop fuel test, disconnect the battery system from the engine.

5. Check the air filter for a carbon build-up. To stop fuel test, disconnect the battery system from the engine.

6. Check the air filter for a carbon build-up. To stop fuel test, disconnect the battery system from the engine.

7. Check the air filter for a carbon build-up. To stop fuel test, disconnect the battery system from the engine.

8. Check the air filter for a carbon build-up. To stop fuel test, disconnect the battery system from the engine.

9. Check the air filter for a carbon build-up. To stop fuel test, disconnect the battery system from the engine.

10. Check the air filter for a carbon build-up. To stop fuel test, disconnect the battery system from the engine.

11. Check the air filter for a carbon build-up. To stop fuel test, disconnect the battery system from the engine.

12. Check the air filter for a carbon build-up. To stop fuel test, disconnect the battery system from the engine.

13. Check the air filter for a carbon build-up. To stop fuel test, disconnect the battery system from the engine.

14. Check the air filter for a carbon build-up. To stop fuel test, disconnect the battery system from the engine.

15. Check the air filter for a carbon build-up. To stop fuel test, disconnect the battery system from the engine.

16. Check the air filter for a carbon build-up. To stop fuel test, disconnect the battery system from the engine.

17. Check the air filter for a carbon build-up. To stop fuel test, disconnect the battery system from the engine.

18. Check the air filter for a carbon build-up. To stop fuel test, disconnect the battery system from the engine.

19. Check the air filter for a carbon build-up. To stop fuel test, disconnect the battery system from the engine.

20. Check the air filter for a carbon build-up. To stop fuel test, disconnect the battery system from the engine.

## HIGH ALTITUDE PERFORMANCE ADJUSTMENT INFORMATION (US MODELS)

To improve the EMISSION CONTROL PERFORMANCE of vehicles operated above 4,000 feet, an Environmental Protection Agency (EPA) approved modification may be required for some models. However, any kind of modification is not necessary for the 1982 model KZ1000J, K, and M, and KZ1100B.

## ENGINE VACUUM

### CYLINDER BLOCK, PISTONS (KZ/Z1100B)

Refer to Pg. 3-15 for test procedure and Pg. 9-8 for the service data noting the following:

1. Measure the cylinder compression in the same way as for a carburetor model with the following exception. To stop fuel injector operation during the compression test, disconnect the white/red lead which connects the battery positive terminal to the fuel injection system harness under the left side cover (Pg. 9-3).

## ENGINE LUBRICATION SYSTEM (KZ/Z1100B)

### Oil Pressure Switch Inspection

The 1982 model KZ/Z1100B has no oil pressure switch but has an oil level sensor on the oil pan. See the "LCD FUEL GAUGE AND WARNER UNIT" section for oil level sensor inspection (Pgs. 10-44 through 10-48).

## DFI (DIGITAL FUEL INJECTION) SYSTEM (KZ/Z1100B)

This section explains the diagnostic procedures on the Kawasaki DFI system. Before diagnosing the DFI system, check the items listed below, and replace, add, adjust, or repair if necessary.

- Check the motorcycle for evidence of physical damage.
- There is sufficient fuel in the tank.
- All electrical connectors are clean, tight, and correctly connected. Fuses are not blown out.
- The engine is in good condition. The periodic maintenance should be properly performed.
- The engine is cranked over normally with the starter motor.
- The ignition system operates normally.
- Us model only: Kawasaki Clean Air System operates normally.

Tests in this section include the following:

1. Quick Initial Check
2. Electronic Control System Tests:
  - Injector Signal
  - Control Unit Power Supply (Including Ignition ON signal)
  - Main Relay Wires
  - Fuel Pump Power Supply
  - Pump Relay Wires
  - Injector Wires (Including Battery Voltage Signal)
  - Throttle Opening Angle Signal
  - Engine Speed Signal
  - Air Temperature Signal
  - Engine Temperature Signal
  - Starter Signal
  - Throttle Sensor
  - Throttle Sensor Position
  - Air Temperature Sensor
  - Engine Temperature Sensor
  - Main/Pump Relay
  - Wires and Connectors
3. Fuel System Tests:
  - Fuel Pump
  - Injector
  - Pressure Regulator
  - Fuel Leak
  - Fuel System Cleaning
  - Fuel Filter
4. Air System Tests:
  - Throttle Valves
  - Air Leak
  - Surge Tank Draining

**NOTE:** 1. If above all inspections prove good but the engine still operates poorly, the trouble may be caused by the engine itself. Overhaul the engine. Especially inspect the pistons and cylinders for wear and seizure, piston rings for sticking, and valve seats for any irregularity. Remove the carbon from the piston heads, piston ring grooves, cylinder head, and valves.

The following three figures show location of DFI system connectors and their names which are referred to in this section.

1. Loosen the front fork lower clamp bolts (4) to remove the fork tubes from the steering stem after adjusting.

**NOTE:** 1. Do not loosen the fork upper clamp bolt (2) to allow the fork tubes to float themselves during adjustment. This could upset the handlebar holder installation or cause stem head distortion.

## Lubrication

Refer to Pg. 2-20.

## GENERAL LUBRICATION

### Speedometer Cable (KZ/Z1100B)

Apply grease to the speedometer inner cable (Pg. 2-20).

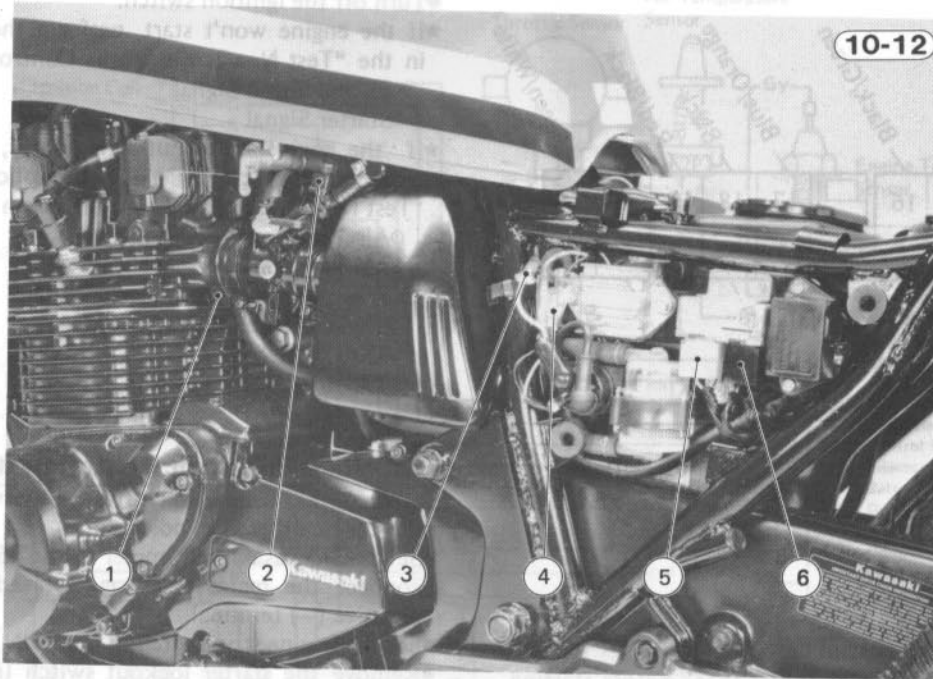

- |  |   |
|--|---|
| <ol style="list-style-type: none"> <li>1. Engine Temperature Sensor Connector</li> <li>2. Injector Connector x 4</li> <li>3. Battery Positive (+) Connector<br/>(referred to "d" in Wiring Diagram)</li> </ol> | <ol style="list-style-type: none"> <li>4. Starter Signal Connector<br/>(referred to "c" in Wiring Diagram)</li> <li>5. Relay White Connector</li> <li>6. Relay Black Connector</li> </ol> |
|--|---|

Table 10-2

Wire Location	Connections
Injector connectors x 4	

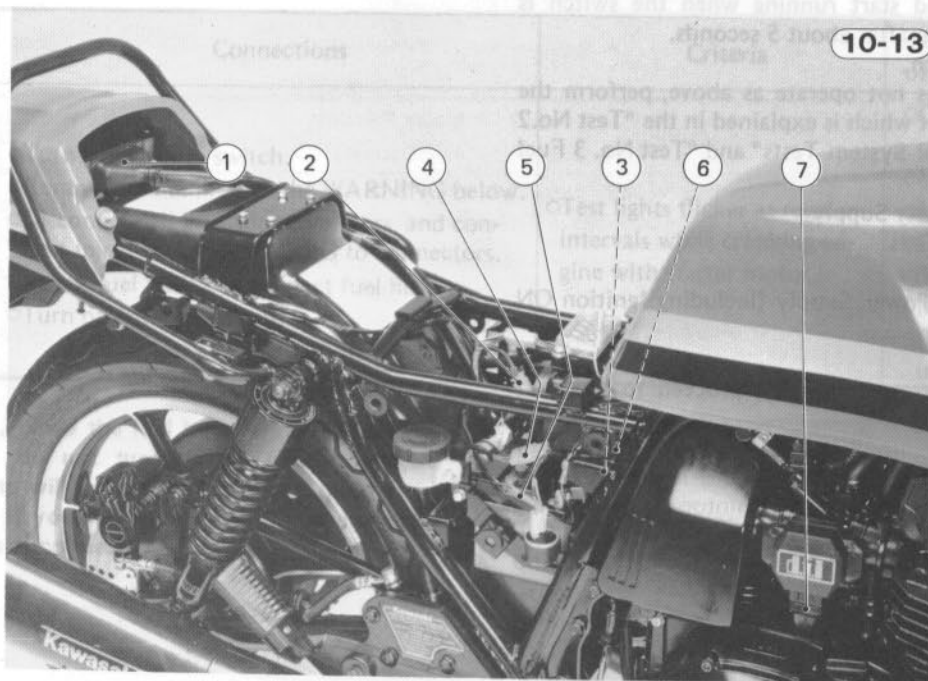

- |  |  |
|--|--|
| <ol style="list-style-type: none"> <li>1. Control Unit Connector</li> <li>2. Ignition Signal 3-Pin Connector<br/>(referred to "a" in Wiring Diagram)</li> <li>3. Pickup Coil 4-Pin Connector between battery and fuel pump</li> <li>4. Air Temperature Sensor 2-P Connector</li> </ol> | <ol style="list-style-type: none"> <li>5. Battery Negative (-) Connector<br/>(referred to "b" in Wiring Diagram)</li> <li>6. Pump 2-Pin Connector between battery and fuel pump</li> <li>7. Throttle Sensor Connector</li> </ol> |
|--|--|

### Pin Numbers and Lead Colors in Control Unit Connector (viewed from Wire Side) 10-14

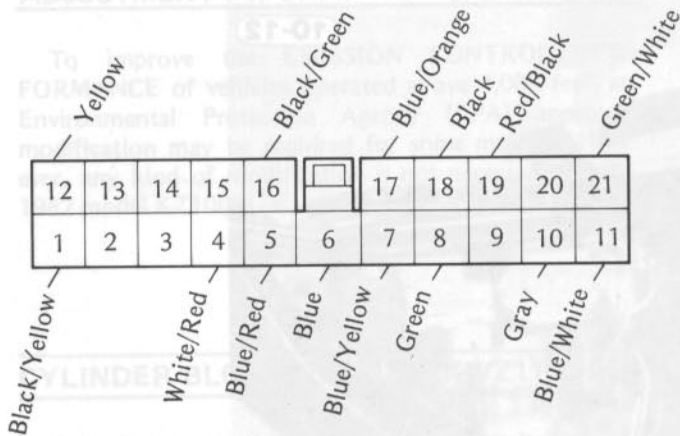

#### Test No. 1 Quick Initial Check:

Give the system a quick initial check before starting a series of time consuming tests, or worse yet, removing parts for repair or replacement. Such a check will often turn up the source of the trouble.

#### Quick Initial Check

- Turn on the ignition switch and listen to the fuel pump. The pump should start running when the switch is turned on and stop after about 5 seconds.
- Turn off the switch.
- ★ If the pump does not operate as above, perform the following test first which is explained in the "Test No. 2 Electronic Control System Tests" and "Test No. 3 Fuel System Tests."
  - Fuel Pump Power Supply
  - Pump Relay Wires
  - Main Relay Wires
  - Control Unit Power Supply (including Ignition ON Signal)
  - Fuel Pump
- ★ If the pump operates normally, proceed to the next check.
- Disconnect the yellow/red lead of the starter motor relay under the left side cover (Fig. 9-13 on Pg. 9-20). This is to prevent the starter motor from working during this inspection.
- Turn on the ignition switch and wait until the pump stops.
- Turn on the starter switch (with the clutch lever pulled in if the starter lockout switch is provided), and listen to the fuel pump.
- ★ If the pump does not run when the starter switch is on, perform the following test in the "Test No. 2 Electronic Control System Tests."
  - Pump Relay Wires
- ★ If the above check shows good pump operation, proceed to the next check.

- Reconnect the yellow/red starter motor relay lead.
- Try starting the engine.
- Turn off the ignition switch.
- ★ If the engine won't start, perform the following tests in the "Test No. 2 Electronic Control System Tests."
  - Engine Speed Signal
  - Starter Signal
- ★ If the engine starts but runs poorly, fuel/air mixture trouble is suspected. Perform the following tests in the "Test No. 2 Electronic Control System Tests."
  - Air Temperature Signal
  - Air Temperature Sensor
  - Engine Temperature Signal
  - Engine Temperature Sensor
  - Throttle Sensor
  - Throttle Sensor Position

#### Test No. 2 Electronic Control System Tests:

When performing each test, observe the following rules unless otherwise indicated:

- Set the Kawasaki multimeter to the 25V DC range, and connect the meter negative (-) lead to the battery negative (-) terminal.
- Set the engine stop switch in the RUN position.
- Remove the starter lockout switch (if it is provided) from the clutch lever holder with the switch leads left connected. This is to crank over the engine only by pushing the starter switch.
- Measure the voltages with all connectors left connected.

NOTE: 1. If above all inspections prove good but the engine will operate poorly, the trouble may be caused by the engine itself. Check the engine. Inspect the valves for wear and adjust them. Check the piston and rings for wear and adjust them. Check the carbon from the under head, and clean it. Check the timing of the valves. Check the timing of the fuel pump. Check the timing of the air temperature sensor. Check the timing of the engine speed signal. Check the timing of the throttle sensor. Check the timing of the throttle sensor position.



Injector Signal Test

10-15

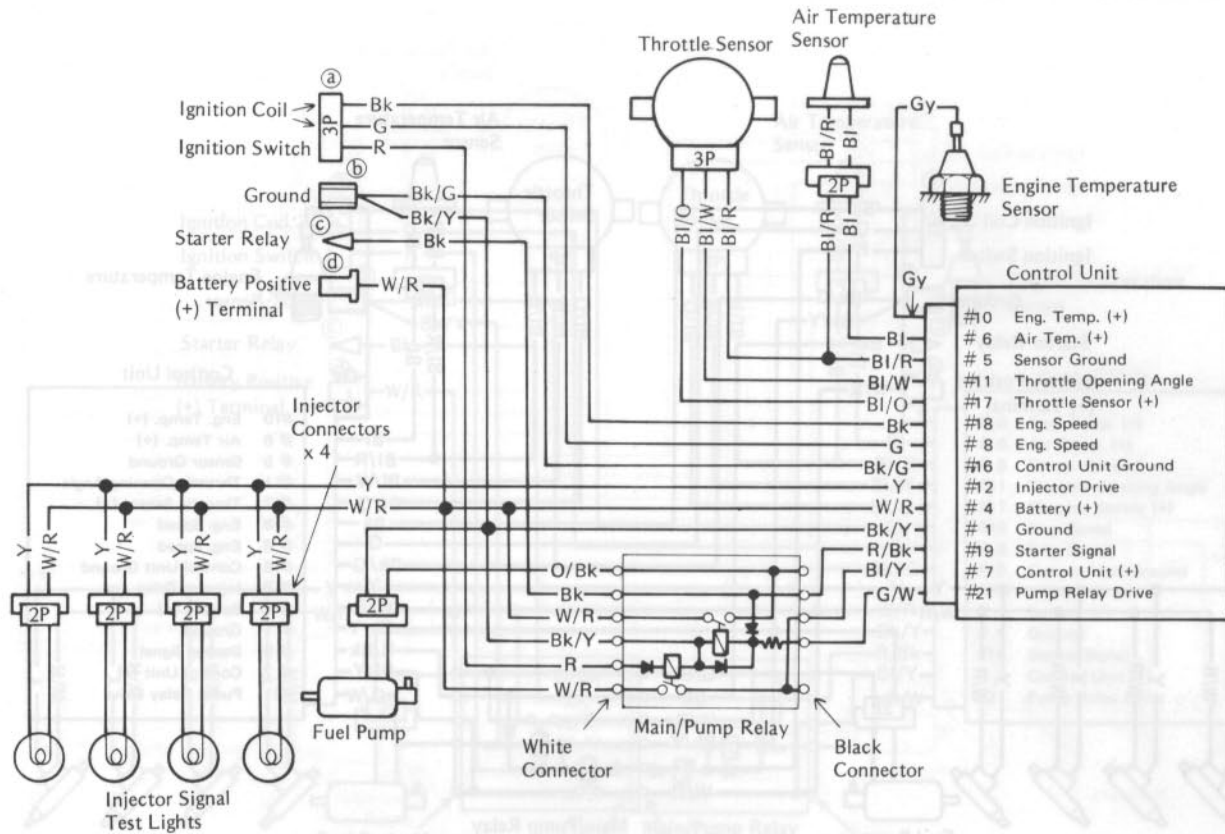
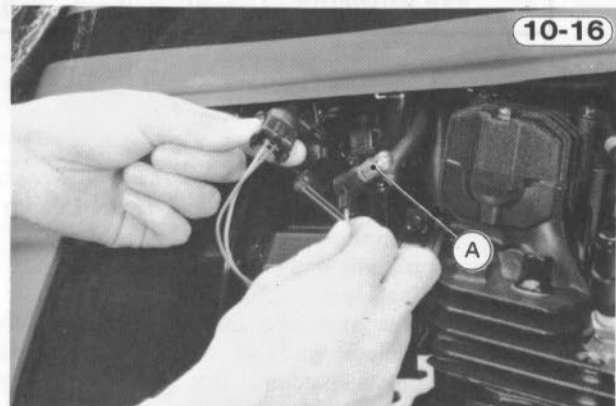

Table 10-2

Wire Location	Connections	Criteria	Test Items when out of Criteria
○Injector connectors x 4	<ul style="list-style-type: none"> <li>○Turn off ignition switch.</li> <li>○Remove fuel tank. See the WARNING below.</li> <li>○Disconnect all injector connectors, and connect injector signal test lights to connectors.</li> <li>○Install fuel tank and connect fuel hoses.</li> <li>○Turn on ignition switch.</li> </ul>	<ul style="list-style-type: none"> <li>○Test lights flicker at regular intervals while cranking engine with starter motor.</li> </ul>	<ul style="list-style-type: none"> <li>○Control unit power supply</li> <li>○Main relay wires</li> <li>○Injector wires</li> <li>○Engine speed signal</li> <li>○Starter signal</li> <li>○Main/pump relay</li> <li>○Replace control unit.</li> </ul>

**WARNING** 1. While the fuel hoses are disconnected, do not turn on the ignition switch. The fuel pump will operate and fuel will spout from the fuel hose if you turn on the ignition switch with the fuel hoses disconnected.



A. Injector Signal Test Light

10-16

Control Unit Power Supply Test  
(including Ignition ON Signal Test)

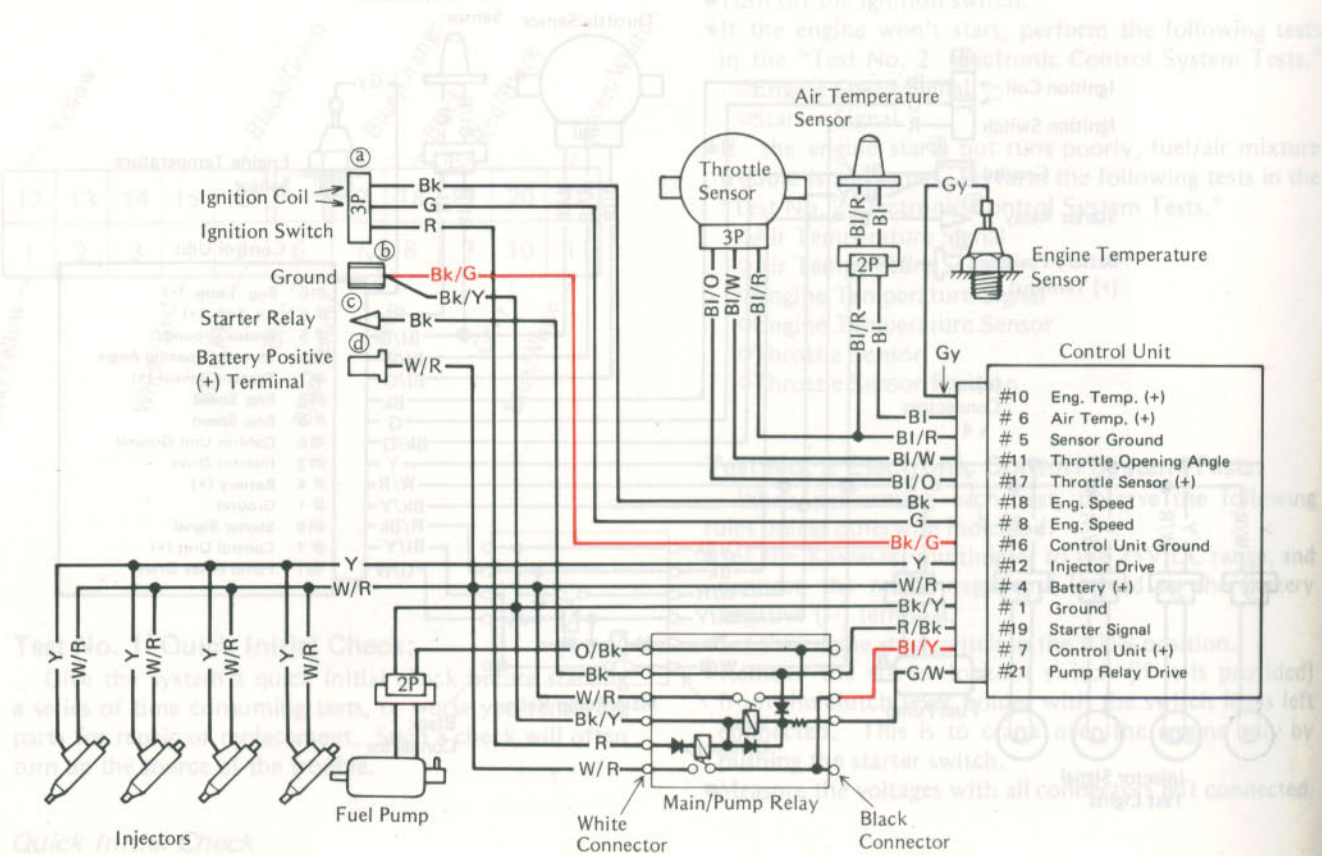
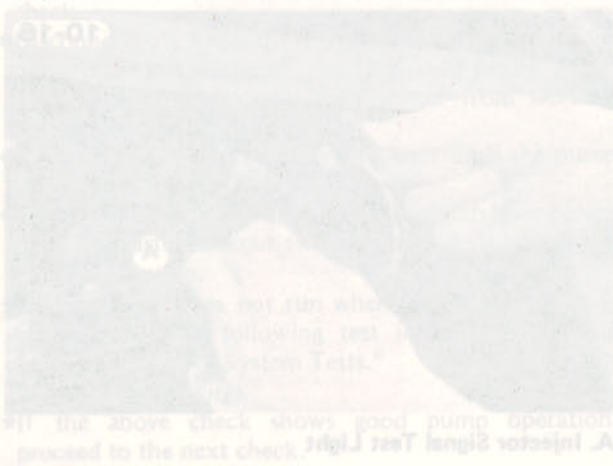

Table 10-3

Wire Location	Connections	Meter Reading (Criteria)	Test Items when out of Criteria
Control unit connector	○ Meter (+) → No.16 pin (black/green wire)	○ 0 V regardless of ignition switch positions.	○ Black/Green wire
	○ Meter (+) → No.7 pin (blue/yellow wire)	○ Battery voltage when ignition switch is on. ○ 0 V when ignition switch is off.	○ Blue/yellow wire ○ Main relay wires ○ Main/pump relay



**WARNING**  
The fuel pump will operate and fuel will squirt from the fuel hose if you turn on the ignition switch with the fuel hoses disconnected.  
While the fuel hoses are disconnected, do not turn on the ignition switch.

Main Relay Wire Test

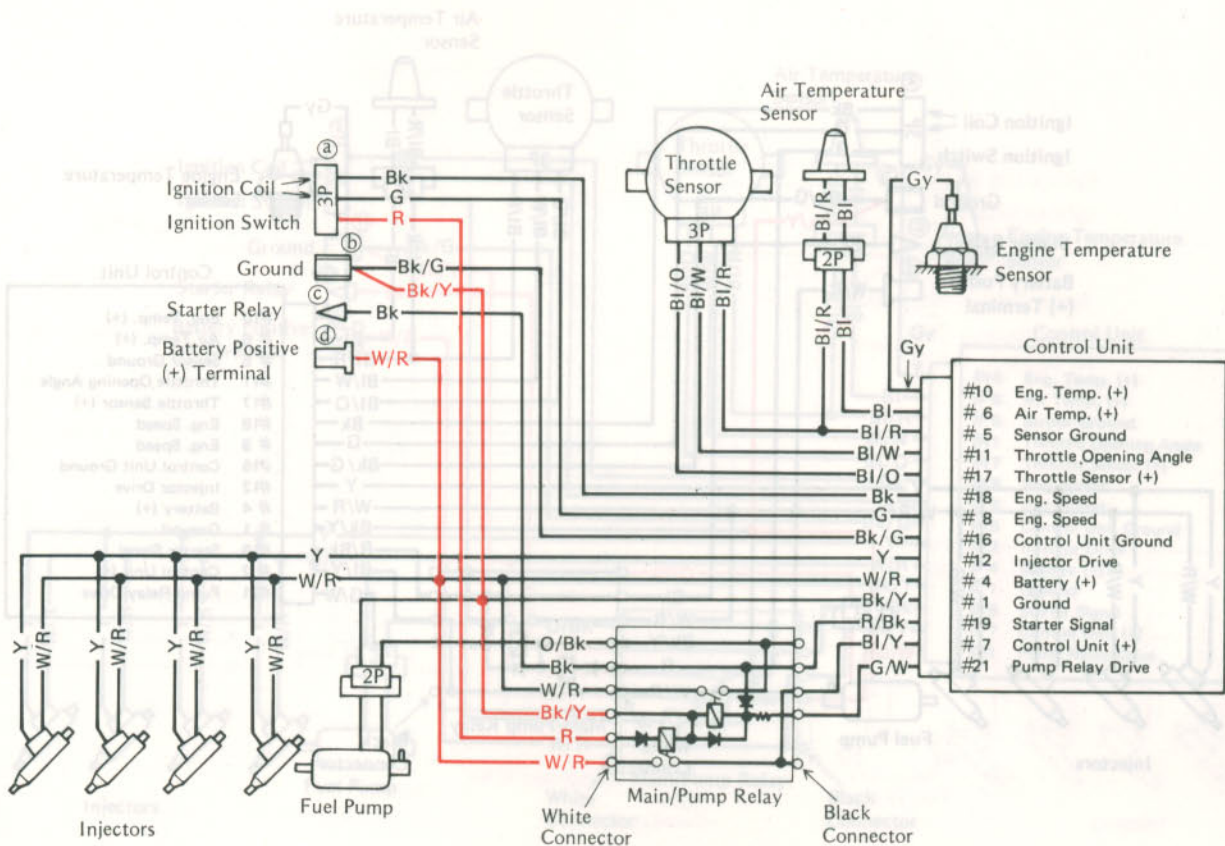

Table 10-4

Wire Location	Connections	Meter Reading (Criteria)	Test Items when out of Criteria
○Relay white connector	○Meter (+) → Black/yellow wire	○0 V regardless of ignition switch positions.	○Black/yellow wire
	○Meter (+) → Red wire	○Battery voltage when ignition switch is on. ○0 V when ignition switch is off.	○Red wire
	○Meter (+) → White/red wire	○Battery voltage regardless of ignition switch positions.	○White/red wire

\*Refer to Pg. 10-26 for how to send the engine speed signal to the control unit.  
 \*Prepare an auxiliary wire which can reach to the battery from the control unit.  
 \*Ground the one end of the wire to the battery negative (-) terminal.  
 \*Connect the other end of the wire repeatedly to the #18 pin (black wire) or #8 pin (green wire) in the control unit connector. This motion sends the engine speed signal to the control unit.  
 \*Remove the auxiliary wire after this test over.

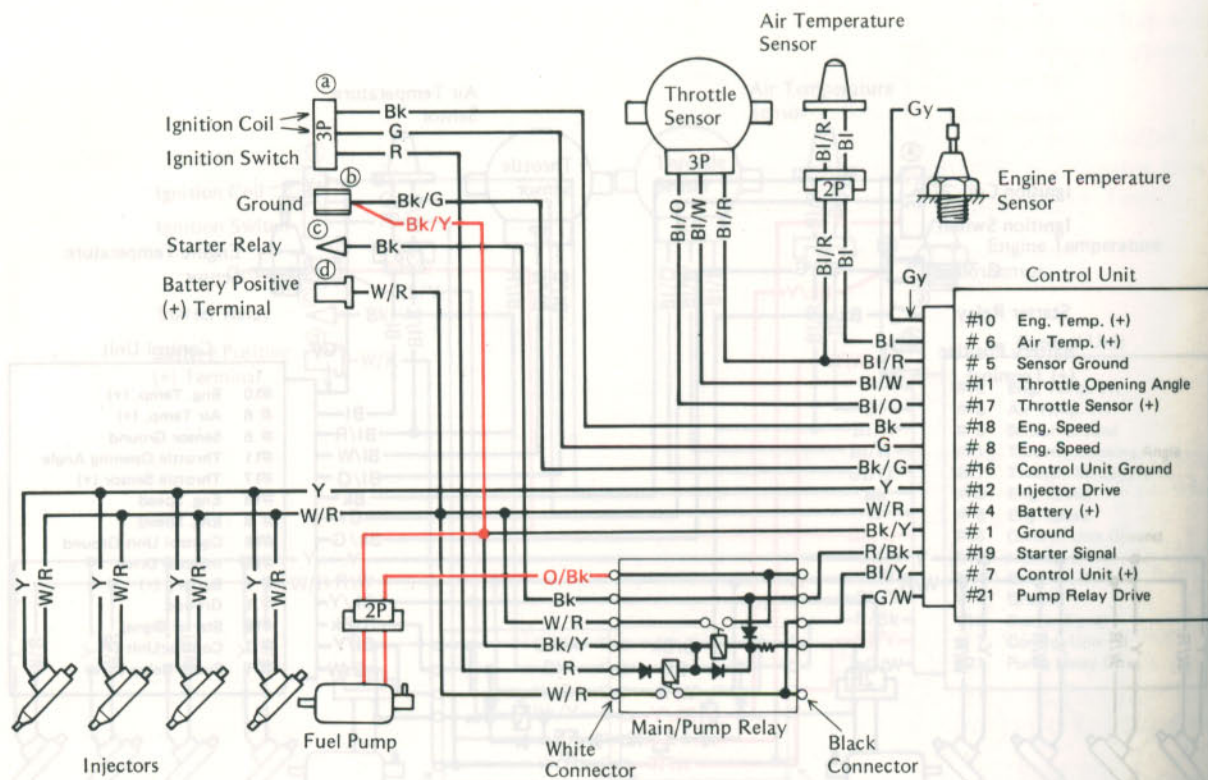

Table 10-5

Wire Location	Connections	Meter Reading (Criteria)	Test Items when out of Criteria
○Fuel pump 2-pin connector	○Meter (+) → Black/yellow wire	○0 V regardless of ignition switch positions.	○Black/yellow wire
	○Meter (+) → Orange/black wire	○Battery voltage for about 5 sec immediately after ignition switch is turned on, then 0 V. ○Battery voltage when starter switch is on. ○0 V when starter switch is off. *○Battery voltage when engine speed signal is sent to control unit, and 0 V in about 1 sec after signal stops.	○Orange/black wire ○Pump relay wires ○Main/pump relay ○Black wire ○Green wire ○Replace control unit.

\*How to send the engine speed signal to the control unit:

- Prepare an auxiliary wire which can reach to the battery from the control unit.
- Ground the one end of the wire to the battery negative (-) terminal.
- Connect the other end of the wire repeatedly to the #18 pin (black wire) or #8 pin (green wire) in the control unit connector. This motion sends the engine speed signal to the control unit.
- Remove the auxiliary wire after this test is over.

Pump Relay Wire Test

10-20

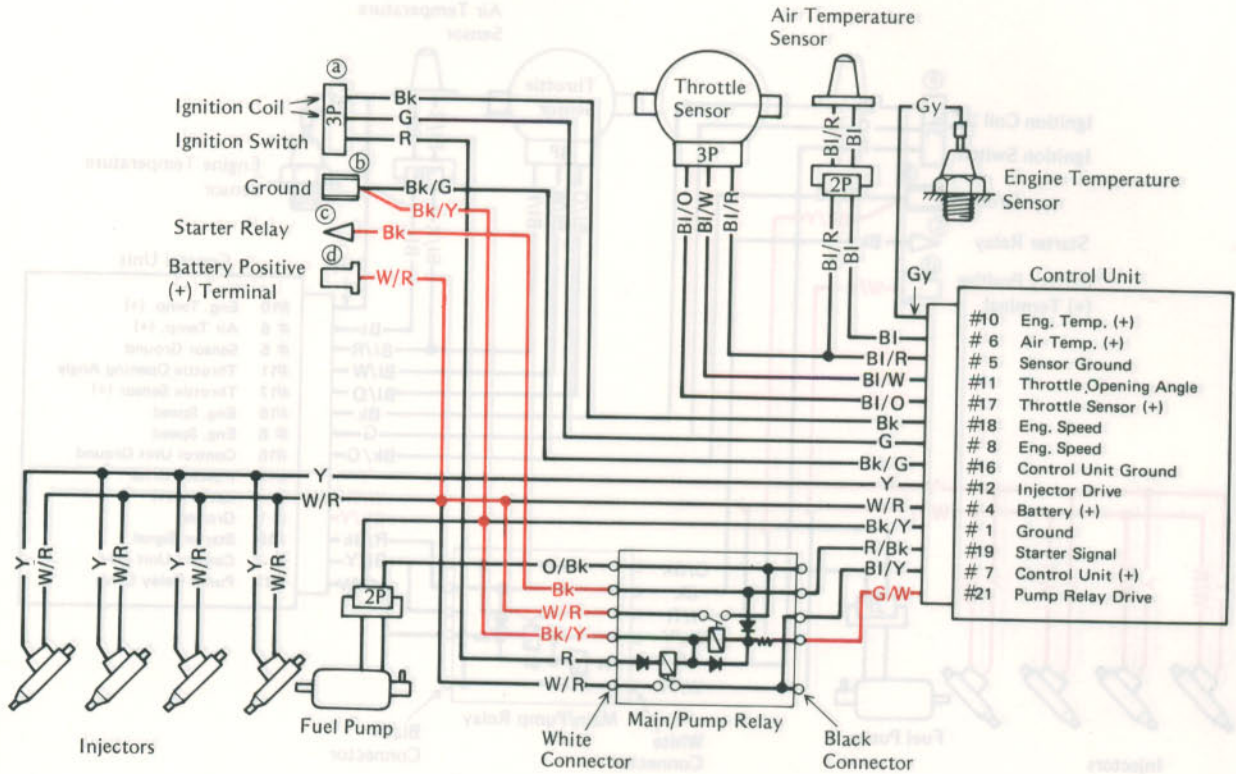

Table 10-6

Wire Location	Connections	Meter Reading (Criteria)	Test Items when out of Criteria
○Relay white connector	○Meter (+) → Black/yellow wire	○0 V regardless of ignition switch positions.	○Black/yellow wire
○Control unit connector	○Meter (+) → No. 21 pin (green/white wire)	○Battery voltage for about 5 sec immediately after ignition switch is turned on, then 0 V. *○Battery voltage when engine speed signal is sent to control unit, and 0 V in about 1 sec after signal stops.	○Green/white wire ○Control unit power supply ○Replace control unit
○Relay white connector	○Meter (+) → Black wire	○Battery voltage when starter switch is on. ○0 V when starter switch is off.	○Black wire
	○Meter (+) → White/red wire	○Battery voltage regardless of ignition switch position.	○White/red wire

\*Refer to Pg. 10-26 for how to send the engine speed signal to the control unit.

**Injector Wire Test**  
(including Battery Voltage Signal Test)

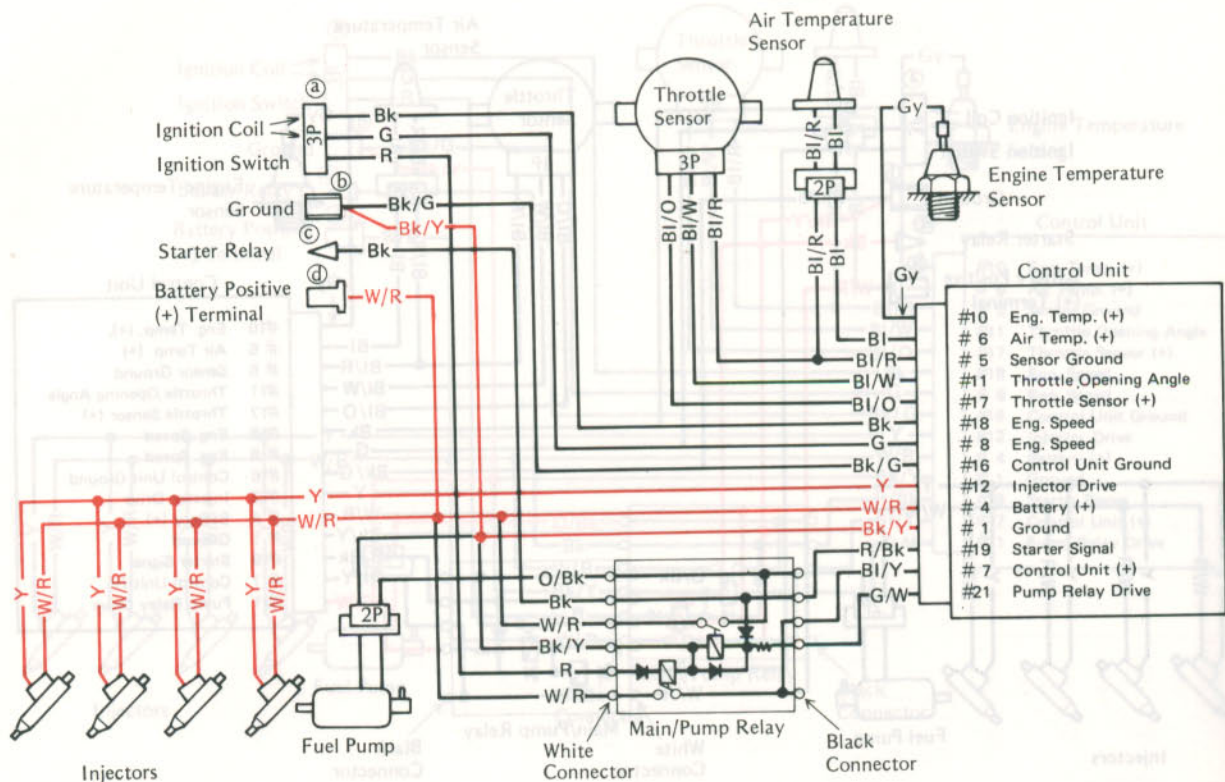

Table 10-5

Wire Location	Connections	Meter Reading (Criteria)	Test Items when out of Criteria
---------------	-------------	--------------------------	---------------------------------

Table 10-7

Wire Location	Connections	Meter Reading (Criteria)	Test Items when out of Criteria
Control unit connector	Meter (+) → No. 12 (yellow wire)	Battery voltage regardless of ignition switch positions.	<ul style="list-style-type: none"> <li>Yellow wire</li> <li>Injectors</li> <li>Injector connectors</li> </ul>
	Meter (+) → No. 4 pin (white/red wire)	Battery voltage regardless of ignition switch positions.	White/red wire
	Meter (+) → No. 1 pin (black/yellow wire)	0 V regardless of ignition switch positions.	Black/yellow wire

Wire Location	Connections	Meter Reading (Criteria)	Test Items when out of Criteria
---------------	-------------	--------------------------	---------------------------------

Refer to Pg. 10-26 for how to send the engine speed signal to the control unit.  
 • Connect the other end of the wire repeatedly to the #18 pin (black wire) or #8 pin (green wire) in the control unit connector. This motion sends the engine speed signal to the control unit.  
 • Remove the auxiliary wire after this test is over.

Throttle Opening Angle Signal Test

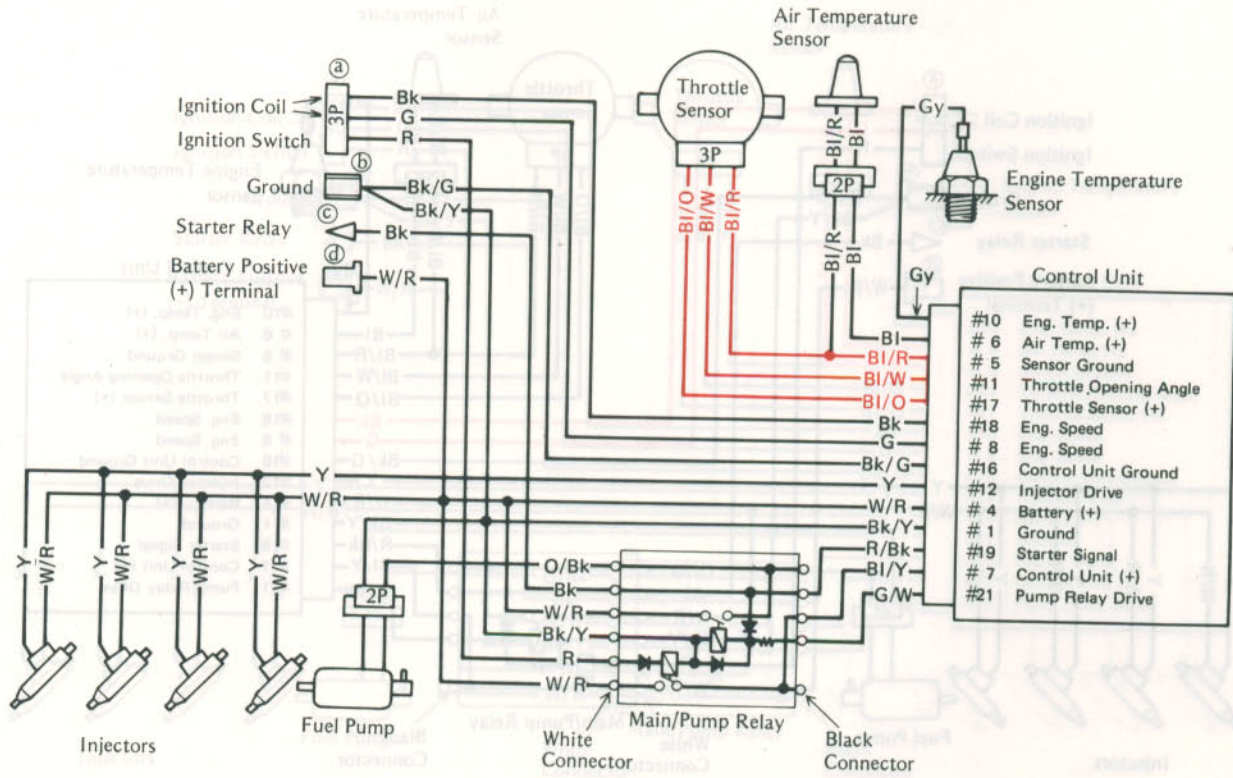

Table 10-8

Wire Location	Connections	Meter Reading* (Criteria)	Test Items when out of Criteria
Control unit connector	○Meter (+) → No.5 pin (blue/red wire)	○0 V regardless of ignition switch positions.	○Blue/red wire ○Replace control unit.
	○Meter (+) → No. 11 pin (blue/white wire)	○0V when ignition switch is off. ○0.5 – 5.2 V when ignition switch is on, decreasing smoothly as throttle opens.	○Blue/white wire ○Throttle sensor ○Throttle sensor position
	○Meter (+) → No. 17 pin (blue/orange wire)	○0 V when ignition switch is off. ○7.2 – 8.8 V when ignition switch is on.	○Blue/orange wire ○Throttle sensor ○Control unit power supply ○Replace control unit.

\*Set the multimeter to the 10V DC range for this test.

Engine Speed Signal Test

(Including Battery Voltage Signal Test)

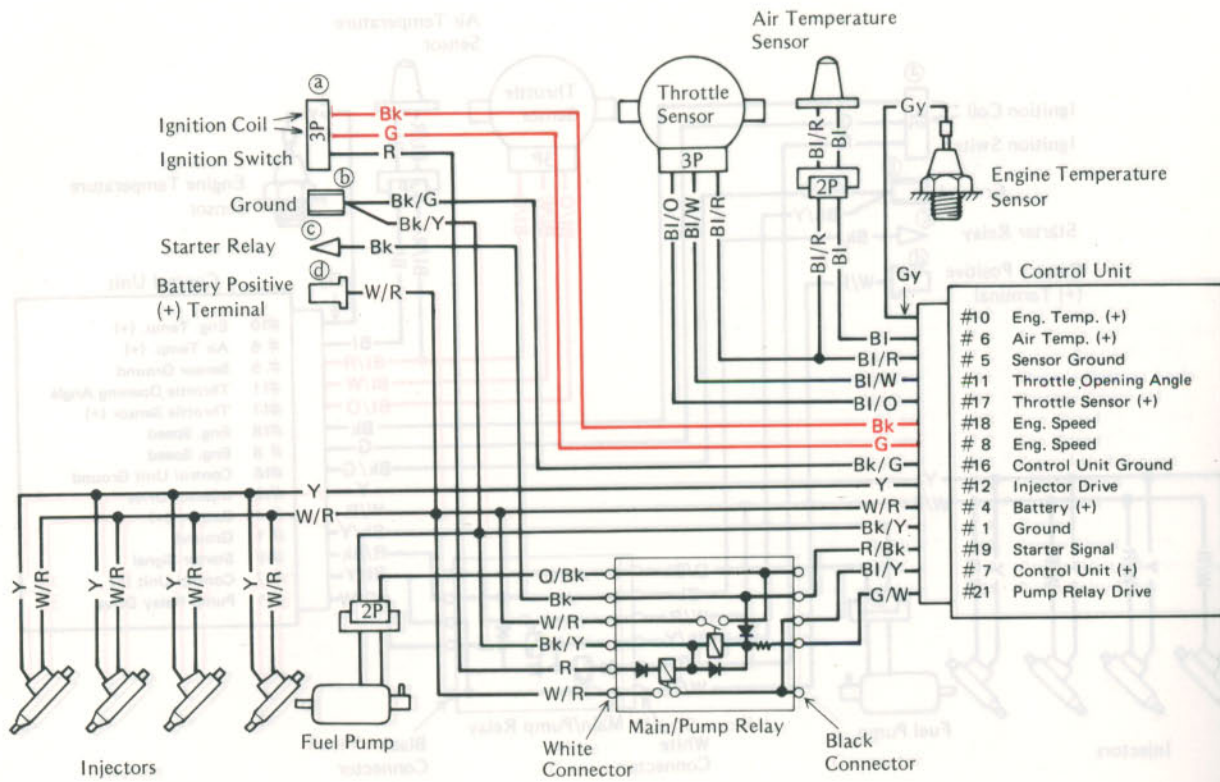

Table 10-9

Wire Location	Connections	Meter Reading (Criteria)	Test Items when out of Criteria
Control unit connector	Meter (+) → No. 8 pin (green wire) or No. 28 pin (black wire)	0 V when ignition switch is off. Battery voltage when ignition switch is on.	Green wire Black wire

Set the multimeter to the 10V DC range for this test.



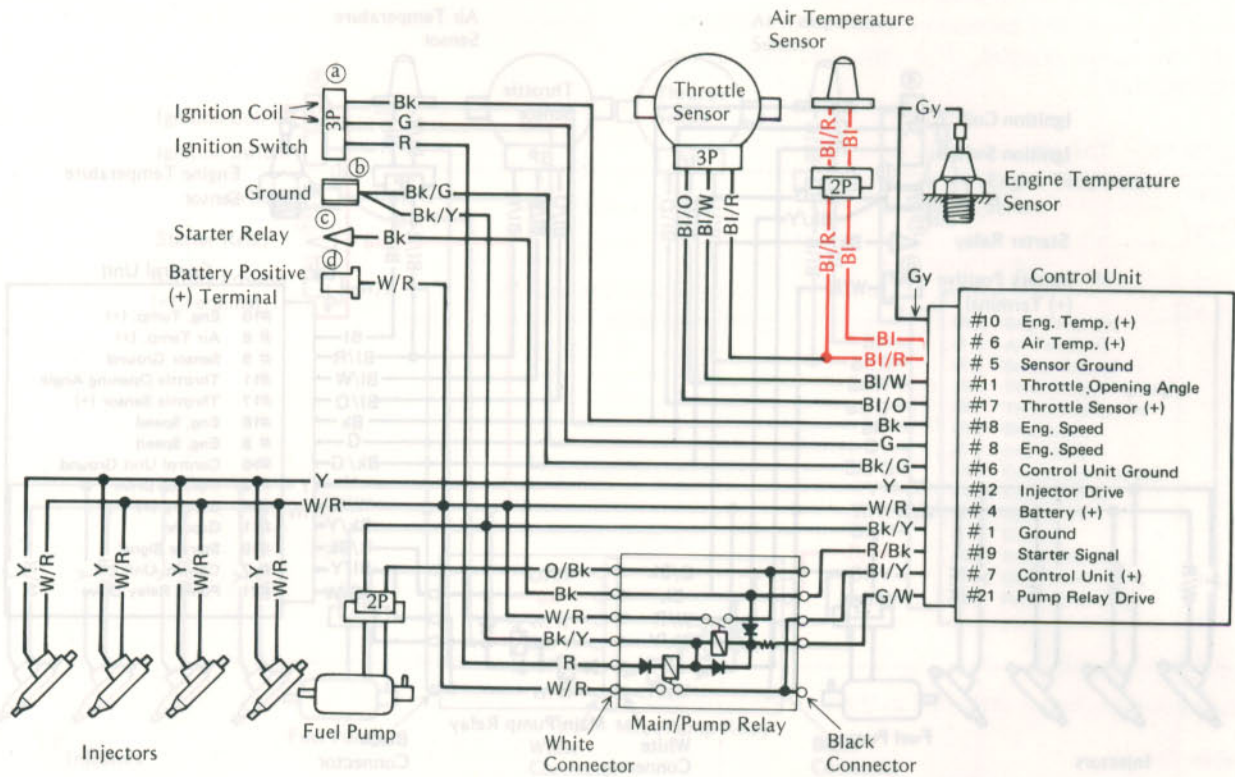

Table 10-10

Wire Location	Connections	Meter Reading* (Criteria)	Test Items when out of Criteria
Control unit connector	Meter (+) → No.6 pin (blue wire)	<ul style="list-style-type: none"> <li>○ 0V when ignition switch is off.</li> <li>**○ 2.0 – 3.1 V when ignition switch is on.</li> <li>○ 3.4 – 4.6 V when temperature sensor 2-pin connector is disconnected and ignition switch is on.</li> </ul>	<ul style="list-style-type: none"> <li>○ Blue wire</li> <li>○ Air temperature sensor</li> <li>○ Control unit power supply</li> <li>○ Replace control unit.</li> </ul>
	Meter (+) → No.5 pin (blue/red wire)	<ul style="list-style-type: none"> <li>○ 0 V regardless of ignition switch positions.</li> </ul>	<ul style="list-style-type: none"> <li>○ Blue/red wire</li> <li>○ Replace control unit.</li> </ul>

\* Set the multimeter to the 10 V DC range for this test.  
 \*\* This is true when sensor temperature is 20°C (68°F), 2.6 – 3.8 V when 0°C (32°F), and 1.7 – 2.5 V when 30°C (86°F).

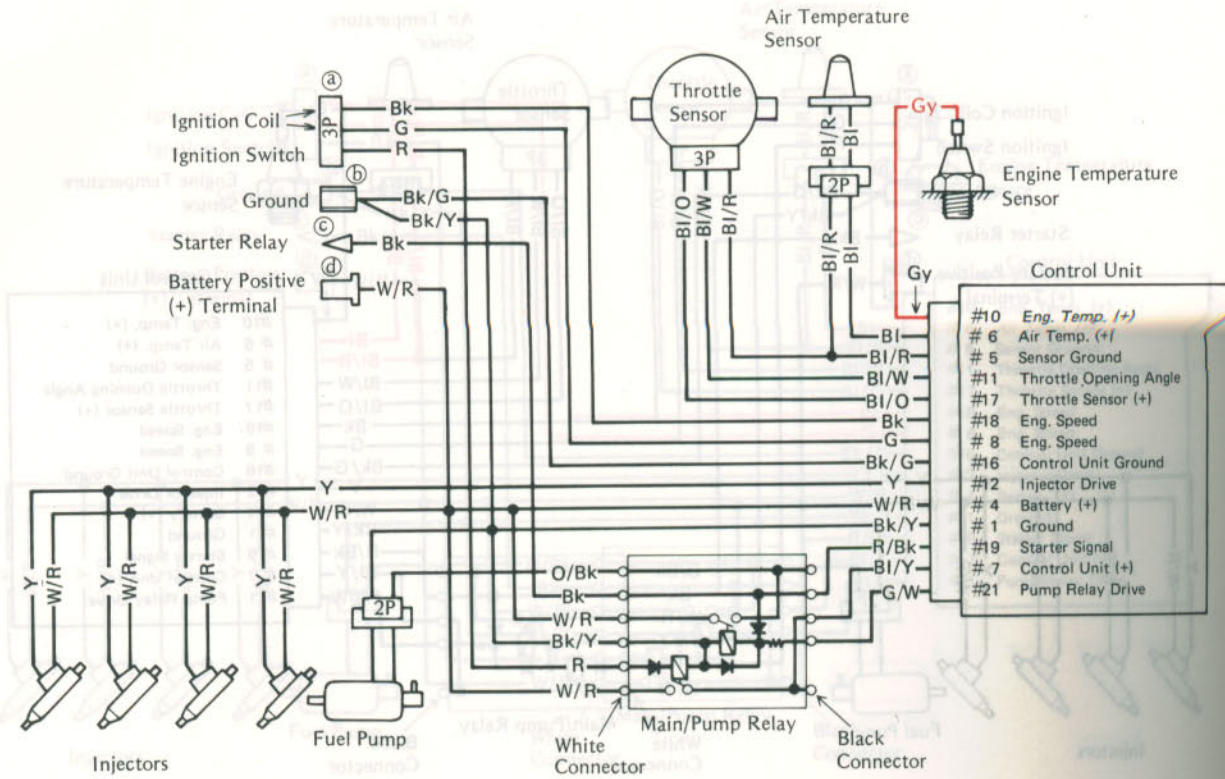

Table 10-11

Wire Location	Connections	Meter Reading* (Criteria)	Test Items when out of Criteria
Control unit connector	Meter (+) → No.10 pin (gray wire)	○ 0 V when ignition switch is off. **○ 2.0 – 3.1 V when ignition switch is on. ○ 3.4 – 4.6 V when gray sensor lead is disconnected from the sensor and ignition switch is on.	○ Gray wire ○ Engine temperature sensor ○ Control unit power supply ○ Replace control unit.

\*Set the multimeter to the 10V DC scale for this test.

\*\*This is true when sensor temperature is 20°C (68°F), 2.6 – 3.8 V when 0°C (32°F), and 0.52 – 0.96V when 80°C (176°F).

Starter Signal Test

10-26

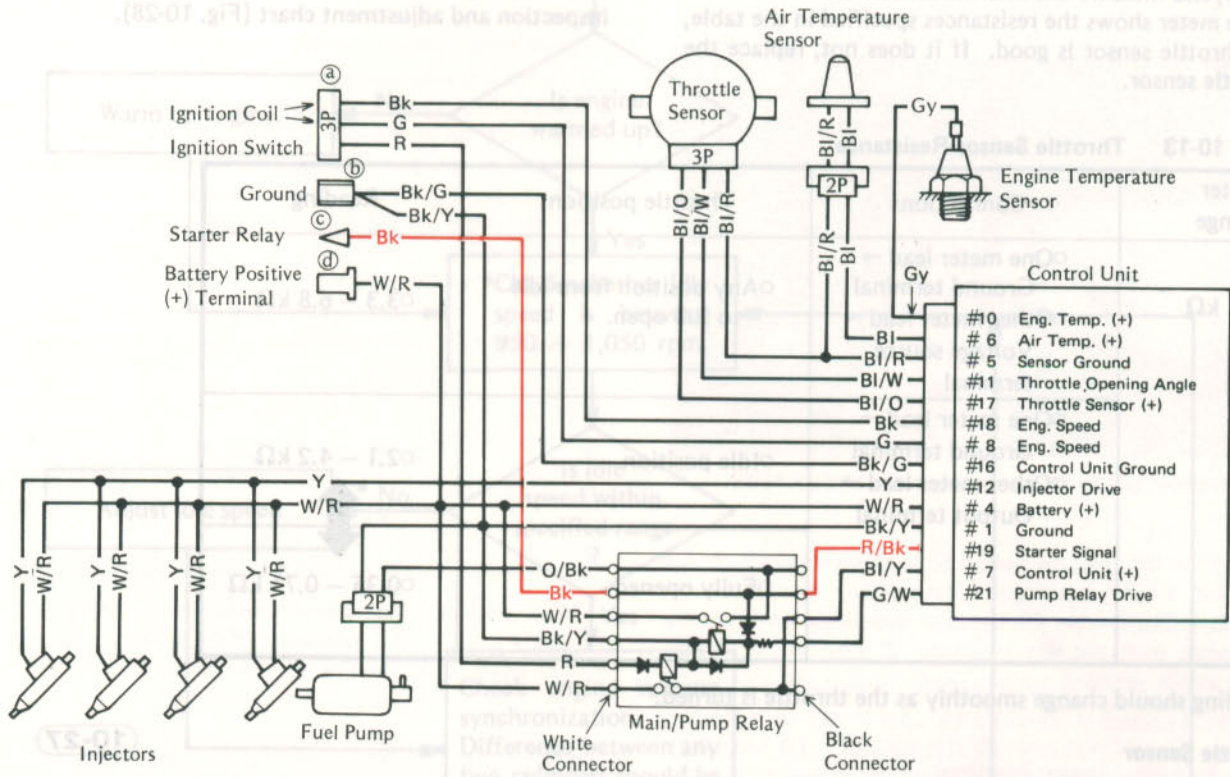

Table 10-12

Wire Location	Connections	Meter Reading (Criteria)	Test Items when out of Criteria
○Control unit connector	○Meter (+) → No.19 pin (red/black wire)	○Battery voltage when starter switch is on.	○Red/black wire ○Main/pump relay
○Relay white connector	○Meter (+) → Black wire	○Battery voltage when starter switch is on.	○Black wire

**Throttle Sensor Test** *Signal Test*

- Turn off the ignition switch.
- Disconnect the connector from the throttle sensor.
- Connect an ohmmeter to the sensor according to Table 10-13, and measure the internal resistance.
- ★ If the meter shows the resistances specified in the table, the throttle sensor is good. If it does not, replace the throttle sensor.

**Throttle Sensor Position Inspection**

Engine performance is sensitive to the throttle sensor position. To obtain the best sensor position, you must use the throttle sensor position checker (special tool 57001-1003) and the vacuum gauge following the inspection and adjustment chart (Fig. 10-28).

**Table 10-13 Throttle Sensor Resistance**

Meter Range	Connections	Throttle position	Reading
x 1 kΩ	○ One meter lead → Ground terminal ○ Other meter lead → Voltage source terminal	○ Any position from idle to full open.	○ 3.3 – 6.8 kΩ
	○ One meter lead → Ground terminal ○ Other meter lead → Output terminal	○ Idle position	○ 2.1 – 4.2 kΩ
		○ Fully opened	○ 0.35 – 0.71 kΩ

\*Reading should change smoothly as the throttle is turned.

10-27

**Throttle Sensor**

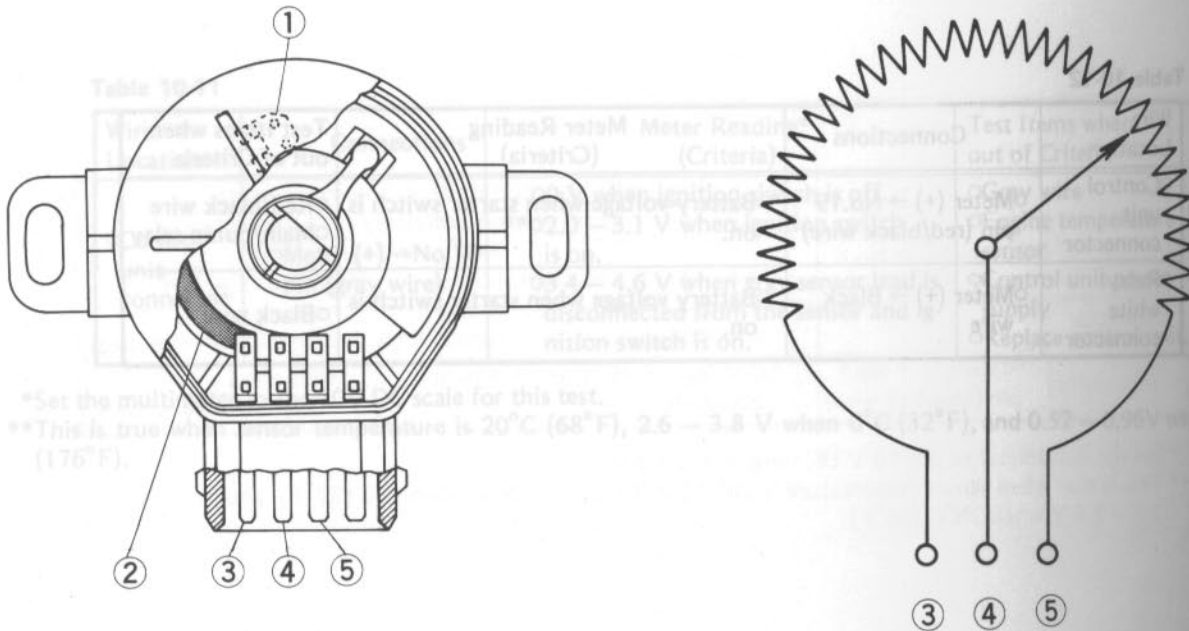

- 1. Brushes
- 2. Carbon Film Resistors
- 3. Ground Terminal

- 4. Output Terminal
- 5. Voltage Source Terminal

\*When the t

### Throttle Sensor Position Inspection and Adjustment Chart

10-28

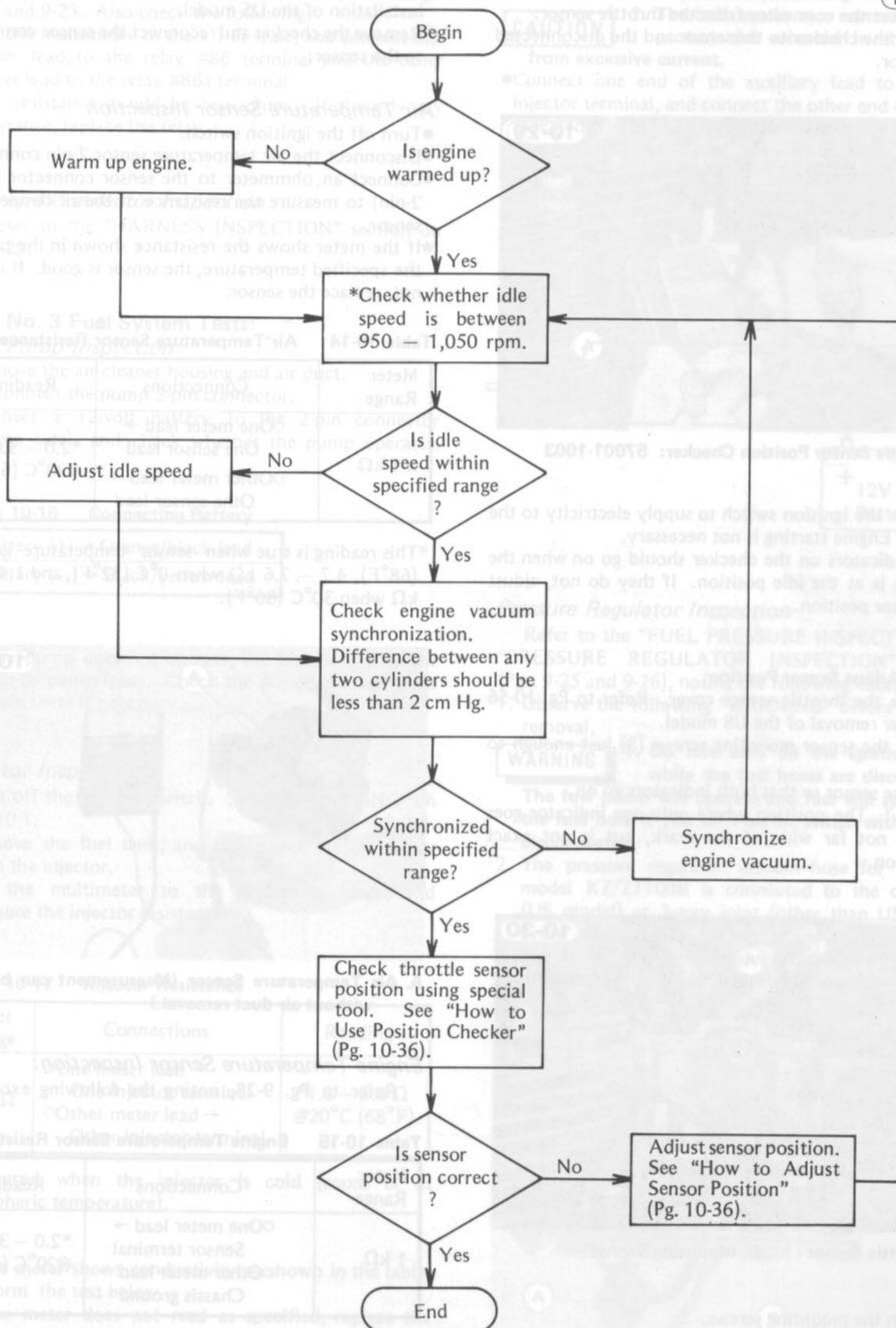

\*When checking idle speed following engine vacuum synchronization inspection, disconnect the vacuum gauge hoses from the throttle valves, and connect the hoses, which lead to the pressure regulator, to the fittings on the throttle valves.

**How to Use Position Checker:**

- Turn off the ignition switch.
- Disconnect the connector from the throttle sensor.
- Connect the checker to the sensor and the disconnected connector.

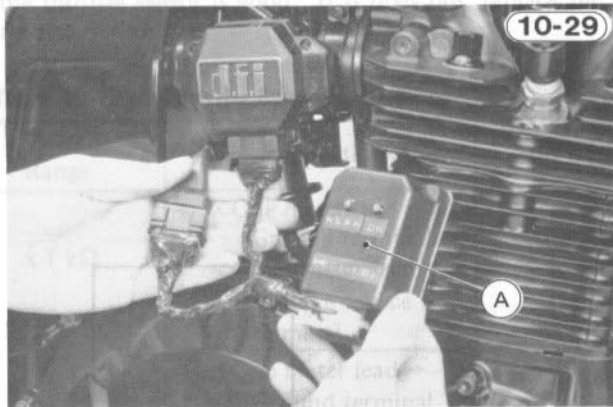

**A. Throttle Sensor Position Checker: 57001-1003**

- Turn on the ignition switch to supply electricity to the sensor. Engine starting is not necessary.
- ★ Both indicators on the checker should go on when the throttle is at the idle position. If they do not, adjust the sensor position.

**How to Adjust Sensor Position:**

- Remove the throttle sensor cover. Refer to Pg. 10-56 for cover removal of the US model.
- Loosen the sensor mounting screws (2) just enough to move.
- Turn the sensor so that both indicators go on.

**NOTE:** 1. The position where only one indicator goes on is not far wide of the mark, but is not exact position.

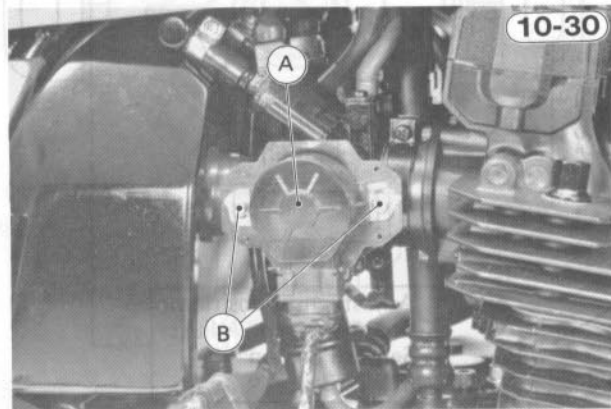

**A. Throttle Sensor      B. Mounting Screws**

- Tighten the mounting screws.
- Open the and close the throttle a few times to make sure both indicators go on. Readjust if necessary.
- Turn off the ignition switch.

- After the sensor is fixed at the best position—
- Install the sensor cover. Refer to Pg. 10-56 for cover installation of the US model.
- Remove the checker and reconnect the sensor connector to the sensor.

**Air Temperature Sensor Inspection**

- Turn off the ignition switch.
- Disconnect the air temperature sensor 2-pin connector.
- Connect an ohmmeter to the sensor connector (male, 2-pin) to measure the resistance of the air temperature sensor.
- ★ If the meter shows the resistance shown in the table at the specified temperature, the sensor is good. If it does not, replace the sensor.

**Table 10-14 Air Temperature Sensor Resistance**

Meter Range	Connections	Reading
x 1 kΩ	○ One meter lead → One sensor lead ○ Other meter lead → Other sensor lead	*2.0 – 3.0 kΩ @20°C (68°F)

\*This reading is true when sensor temperature is 20°C (68°F), 4.7 – 7.6 kΩ when 0°C (32°F), and 1.4 – 2.2 kΩ when 30°C (86°F).

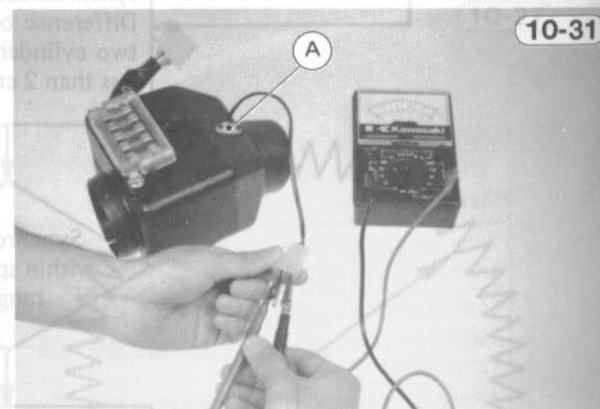

**A. Air Temperature Sensor (Measurement can be done without air duct removal.)**

**Engine Temperature Sensor Inspection:**

Refer to Pg. 9-28, noting the following exception:

**Table 10-15 Engine Temperature Sensor Resistance**

Meter Range	Connections	Reading
1 kΩ	○ One meter lead → Sensor terminal ○ Other meter lead → Chassis ground	*2.0 – 3.0 kΩ @20°C (68°F)

\*This reading is true when sensor temperature is 20°C (68°F), 4.7 – 7.6 kΩ when 0°C (32°F), and 1.4 – 2.2 kΩ when 30°C (86°F).

### Main/Pump Relay Inspection

Refer to the "RELAY INSPECTION" section on Pgs. 9-22 and 9-23. Also check the following:

- Set the multimeter to the  $\times 1 \Omega$  scale, and connect one meter lead to the relay #86 terminal and the other meter lead to the relay #86a terminal.
- ★ The resistance should be zero ohms. If there is any resistance, replace the relay.

### Wire and Connector Inspection

Refer to the "HARNESS INSPECTION" section on Pg. 9-29.

### Test No. 3 Fuel System Tests:

#### Fuel Pump Inspection

- Remove the air cleaner housing and air duct.
- Disconnect the pump 2-pin connector.
- Connect a 12-volt battery to the 2-pin connector (pump side), and check whether the pump operates.

Table 10-16 Connecting Battery

Battery (+) → Orange/black lead
Battery (-) → Black/yellow lead

- ★ If the pump does not operate, the trouble is with the pump or pump leads. Check the pump and leads, and replace them if necessary.

#### Injector Inspection

- Turn off the ignition switch. See the "WARNING" on Pg. 10-1.
- Remove the fuel tank, and disconnect the connector from the injector.
- Set the multimeter to the ohmmeter range, and measure the injector resistance.

Table 10-17 Injector Resistance

Meter Range	Connections	Reading
$\times 1 \Omega$	○ One meter lead → One injector terminal ○ Other meter lead → Other injector terminal	*1.8 – 3.0 $\Omega$ @20°C (68°F)

\*Measured when the injector is cold (room or at atmospheric temperature).

- ★ If the meter shows conductivity as shown in the table, perform the test below.
- ★ If the meter does not read as specified, replace the injector.
- Prepare an auxiliary lead, a 12V 21 – 23W rating bulb with leads, and a 12-volt battery.

- Connect the bulb between the battery positive (+) terminal and one injector terminal.

**CAUTION** 1. The bulb works as a current limiter to protect the solenoid in the injector from excessive current.

- Connect one end of the auxiliary lead to the other injector terminal, and connect the other end of the lead repeatedly to the battery negative (-) terminal.
- ★ The injector should click every time the lead contacts to the battery terminal. If the injector does not click, replace the injector.

### Injector Inspection

10-32

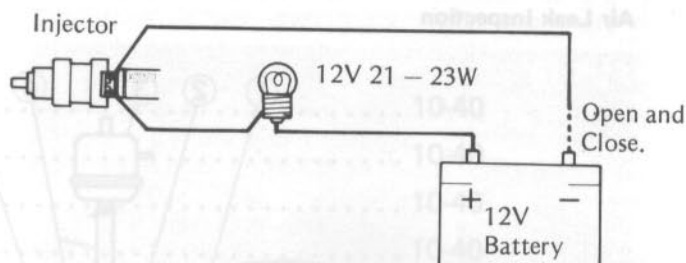

### Pressure Regulator Inspection

Refer to the "FUEL PRESSURE INSPECTION" and "PRESSURE REGULATOR INSPECTION" sections (Pgs. 9-25 and 9-26), noting the following exceptions:

1. Observe the following "WARNING" before fuel tank removal.

**WARNING** 1. Do not turn on the ignition switch while the fuel hoses are disconnected.

The fuel pump will operate and fuel will spout from the fuel hose if you turn on the switch with the hose disconnected.

2. The pressure regulator vacuum hose for the 1982 model KZ/Z1100B is connected to the cross-joint (US model) or 3-way joint (other than US model). From the joint the vacuum hoses are connected to the #1 and #4 throttle valves, and also connected to the vacuum switch valve for the US model.

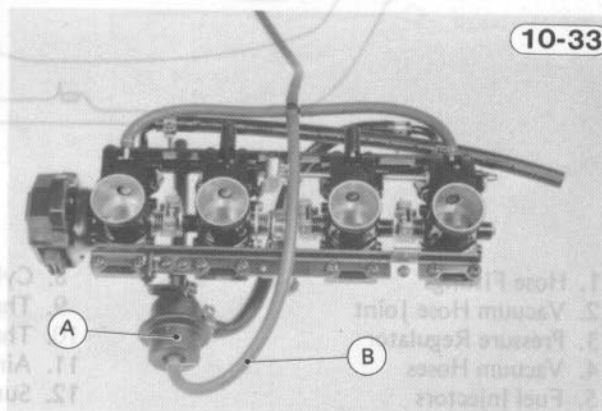

10-33

A. Pressure Regulator

B. Vacuum Hoses

**Fuel Leak Inspection**

Inspect the connections between the parts shown in Fig. 9-29 on Pg. 9-27 for fuel leaks.

**Fuel System Cleaning**

Refer to the "FUEL SYSTEM CLEANING" section noting the following exceptions:

1. Observe the "WARNING" on Pg. 10-1 before fuel tank removal.

**Fuel Filter Inspection**

Refer to the "FUEL FILTER INSPECTION" on Pg. 9-26.

**Air Leak Inspection**

**Test No.4 Air System Inspection:**

**Throttle Valve Inspection**

- Check the engine vacuum synchronization (Pg. 10-18).
- Check the throttle valve link mechanism referring to the "Link Mechanism Inspection" on Pg. 9-29.

**Air Leak Inspection**

- Inspect the connections between the parts shown in Fig. 10-34 for air leaks.

**Surge Tank Draining**

Refer to the "SURGE TANK DRAIN PLUG" section on Pg. 9-30.

10-34

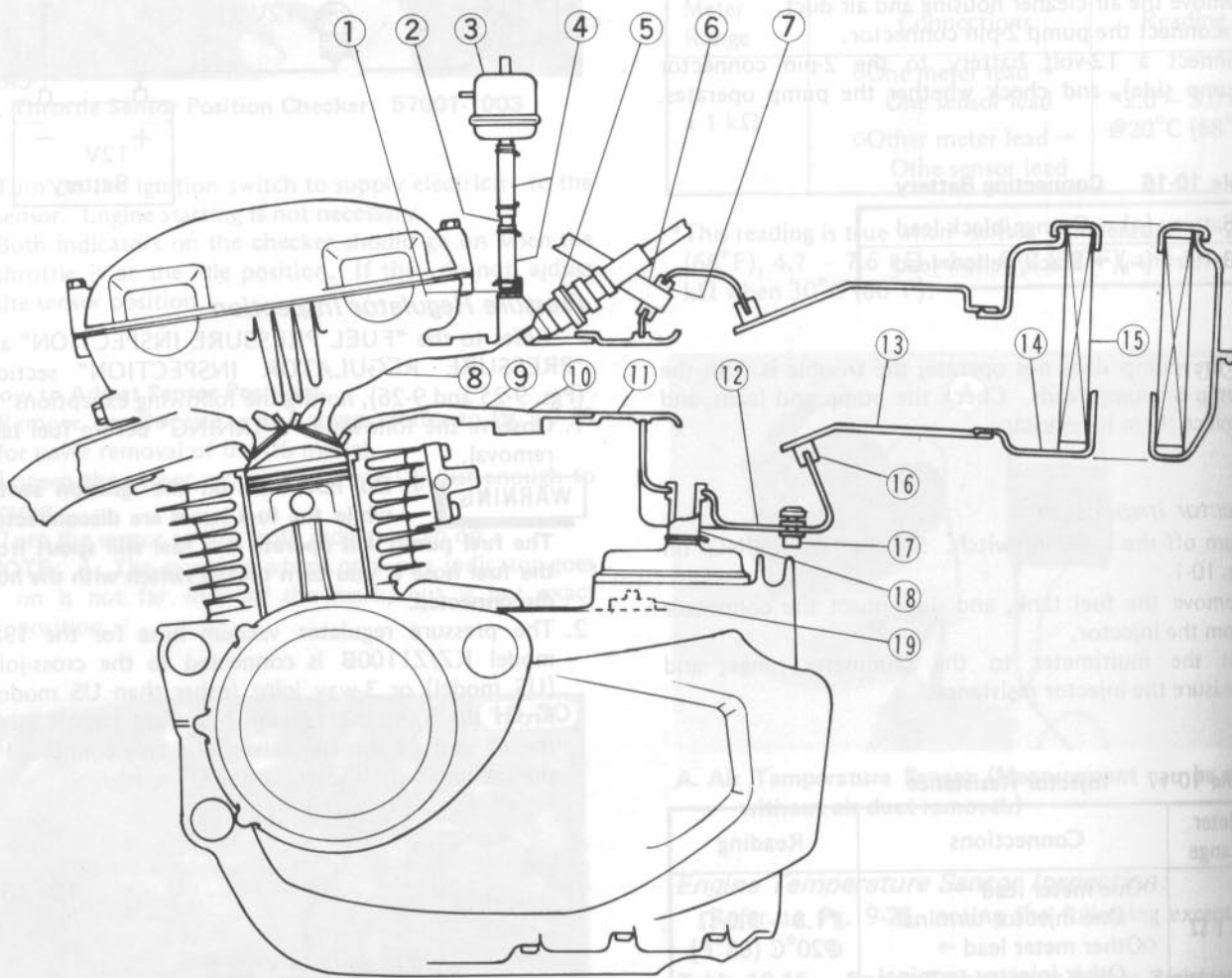

1. Hose Fittings
2. Vacuum Hose Joint
3. Pressure Regulator
4. Vacuum Hoses
5. Fuel Injectors
6. Air Hose (US model)
7. Rubber Seal (US model)

8. Cylinder Head
9. Throttle Valve Holders
10. Throttle Valves
11. Air Ducts
12. Surge Tank
13. Air Duct
14. Air Cleaner Housing

15. Air Cleaner Element
16. Rubber Seal
17. Drain Plug
18. Breather Hose
19. Oil Filler Cap



# Non-scheduled Maintenance – Electrical

## Table of Contents

SPEEDOMETER (KZ/Z1100B) .....	10-40
ODOMETER (KZ/Z1100B) .....	10-40
TRIP METER (KZ/Z1100B) .....	10-40
TACHO/VOLTMETER (KZ/Z1100B) .....	10-40
LCD FUEL GAUGE AND WARNER UNIT (KZ/Z1100B) .....	10-44
LOW FUEL WARNING SYSTEM (KZ1000M) .....	10-49
ELECTRIC STARTER SYSTEM .....	10-50

- A. Rubber D
- B. Mounting

### Test No. 2 Meter Power Supply Test

- Use the voltmeter as shown in Table 10-18 to check that the meter is powered by the battery.
- Turn on the ignition switch and measure the lead voltage.
- If the meter does not show battery voltage, the battery power does not reach the meter.

Table 10-18 Meter Power Supply

Meter Range	Connections	Reading (Criteria)
25V DC	Tachometer (+) to Brown lead Tachometer (-) to Black/Yellow lead	Battery voltage



A. Brown Lead B. Black/Yellow Lead

### Test No. 3 Engine Speed Sensor Test

The speedometer, odometer, and trip meter on the 1981 model KZ1100B are driven mechanically through a flexible meter cable. Disconnect the wires

Meter Range	Connections	Reading
10V DC	(+) to Black lead (-) to Brown lead	engine rpm x 0.05

The 1981 model KZ1100B has an electrically driven speedometer.

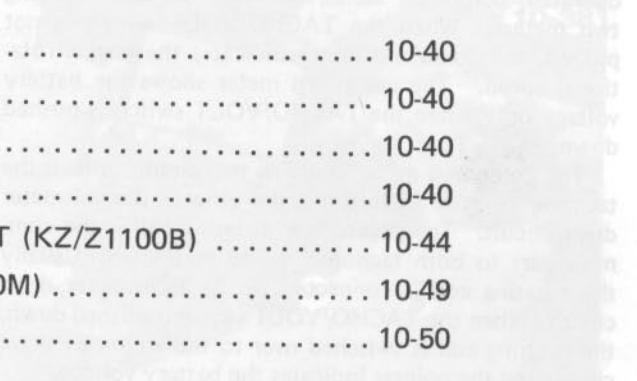

A. Brown Lead B. Black Lead

### Test No. 4 Switch-Over Switch Test

- Disconnect the three wires (green, red, and yellow).
- Use the ohmmeter to check the conductivity between the terminals.



A. Switch Leads

**SPEEDOMETER (KZ/Z1100B)  
ODOMETER (KZ/Z1100B)  
TRIP METER (KZ/Z1100B)**

The speedometer, odometer, and trip meter on the 1982 model KZ/Z1100B are driven mechanically through a flexible meter cable. Troubleshoot the meters using the same procedures as for an ordinary cable driven meter.

**TACHO/VOLTMETER (KZ/Z1100B)**

The 1982 model KZ/Z1100B has an electrically operated, combined tachometer instead of having two meters. When the TACHO/VOLT switch is not pushed, the combined meter indicates the engine rotational speed. The combined meter shows the battery voltage only when the TACHO/VOLT switch is pushed down.

The combined meter contains two circuits, one is the tachometer drive circuit and the other is the voltmeter drive circuit. The pointer and rotating coil is the common part to both tachometer and voltmeter. Usually the rotating coil is connected to the tachometer drive circuit. When the TACHO/VOLT switch is pushed down, the rotating coil is switched over to the voltmeter drive circuit and the pointer indicates the battery voltage.

**Tacho/Voltmeter Troubleshooting Guide:**

If trouble is suspected in the tacho/voltmeter system, check the system using two test charts. One chart is titled "Chart No. 1 Tachometer Test," and the other "Chart No. 2 Voltmeter Test." Test procedures in the charts are explained individually below. When one of the two meters is malfunctioning, follow the appropriate test chart. If neither meter does not operate correctly; first test the tachometer, and then test the voltmeter.

- NOTE:** 1. The Tacho/Voltmeter Troubleshooting Guide is explained on the assumption that the ignition system operates normally.  
2. The tacho/voltmeter connector (white, 6-pin) is in the headlight housing.  
3. Remove the fairing, headlight, and meter assembly bottom cover before starting troubleshooting.  
4. If the inspection proves that the combined meter system is good, but the system still shows trouble while riding; test the system while the engine is running. Trouble may be caused from engine vibration.

**Tacho/Voltmeter Block Diagram**

10-35

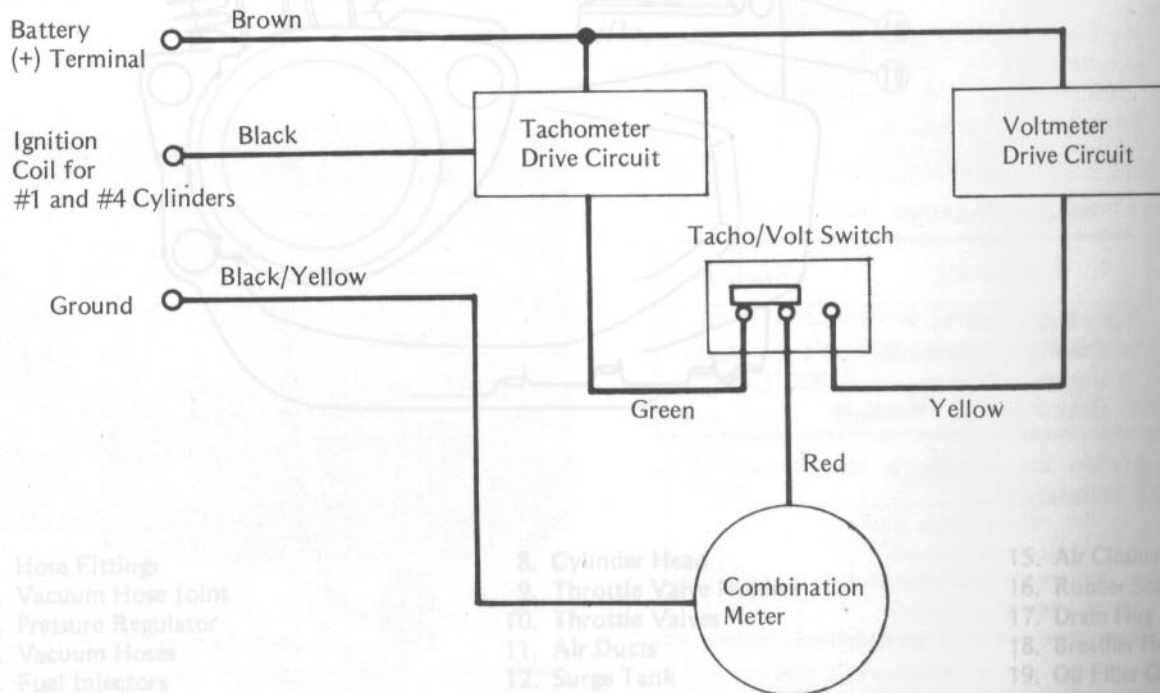

- 1. Hose Fitting
- 2. Vacuum Hose Joint
- 3. Pressure Regulator
- 4. Vacuum Hoses
- 5. Fuel Injectors
- 6. Air Hose (US model)
- 7. Rubber Seal (US model)

- 8. Cylinder Head
- 9. Throttle Valve
- 10. Throttle Valve
- 11. Air Ducts
- 12. Surge Tank
- 13. Air Duct
- 14. Air Cleaner Housing

- 15. Air Cleaner Element
- 16. Rubber Seal
- 17. Drain Plug
- 18. Breather Plug
- 19. Oil Filter Cap

A. Br

**Test No. 1 Meter Mounting Inspection**

- Check to see that the rubber dampers (4) are installed at the meter mounting bracket.
- ★ Install a new damper where it is absent.
- Check to see that the rubber dampers (4) at the meter mounting bracket is in good conditions; they should not harden or cracked.
- ★ Replace any damaged rubber dampers with new ones.
- Check to see that all meter mounting bolts, nuts, and screws are tightened securely.
- ★ Tighten the loose fasteners.

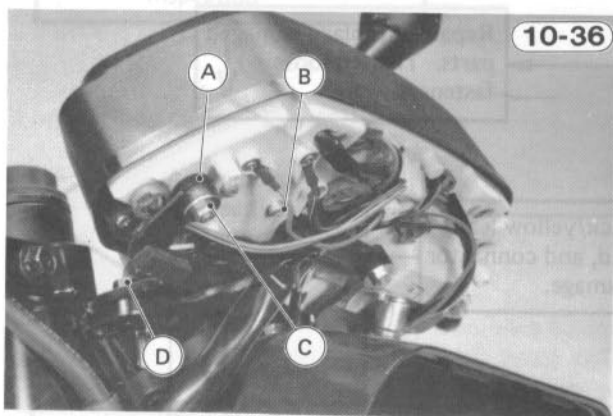

A. Rubber Dampers      C. Mounting Nuts  
B. Mounting Screws    D. Mounting Bolts

**Test No. 2 Meter Power Supply Test**

- Use the voltmeter as shown in Table 10-18 to check that the meter is powered by the battery.
- Turn on the ignition switch, and measure the lead voltage.
- ★ If the meter does not show battery voltage, the battery power does not reach the meter.

**Table 10-18 Meter Power Supply**

Meter Range	Connections	Reading (Criteria)
25V DC	○ Meter (+) → Brown lead ○ Meter (-) → Black/yellow lead	○ Battery voltage

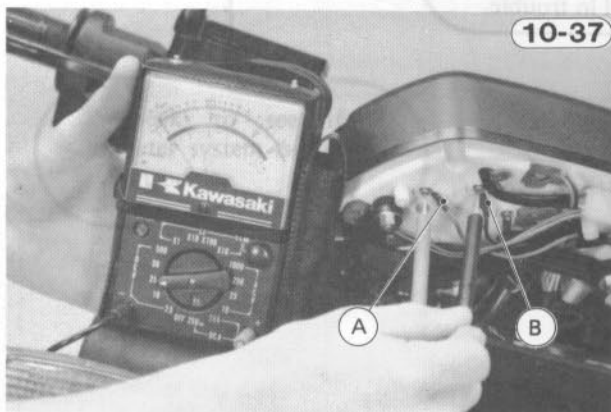

A. Brown Lead      B. Black/Yellow Lead

**Test No. 3 Engine Speed Signal Test**

- Use the voltmeter as shown in Table 10-19 to check the engine speed signal is sent to the meter.
- Turn on the ignition switch, and read the voltmeter.
- Start the engine, and read the voltmeter.
- ★ If the meter does not show the voltage shown in the table, the signal does not reach the meter.

**Table 10-19 Engine Speed Signal**

Meter Range	Connections	Reading
10V DC	○ Meter (+) → Brown lead ○ Meter (-) → Black lead	○ 0 V when engine is stopped. ○ 2 - 4 V when engine is running.

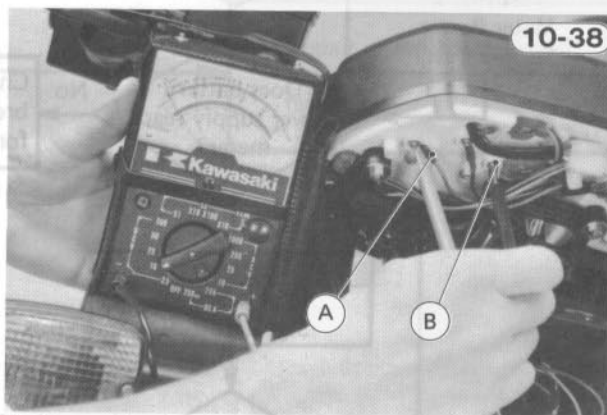

A. Brown Lead      B. Black Lead

**Test No. 4 Switch-Over Switch Test**

- Disconnect the three switch-over switch leads (green, red, and yellow).
- Use the ohmmeter to check the conductivity between two leads at a time (3 possible combinations).
- ★ If any two leads do not show the conductivity shown in Table 10-20, replace the switch.

**Table 10-20 Switch-Over Switch Connections**

	Green	Red	Yellow
Release	●	●	
Push		●	●

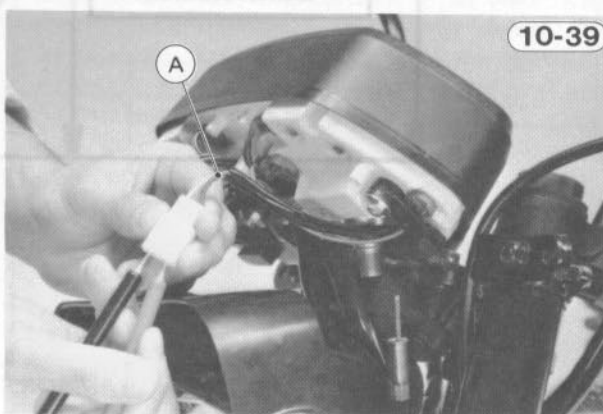

A. Switch Leads

Chart No. 1 Tachometer Test

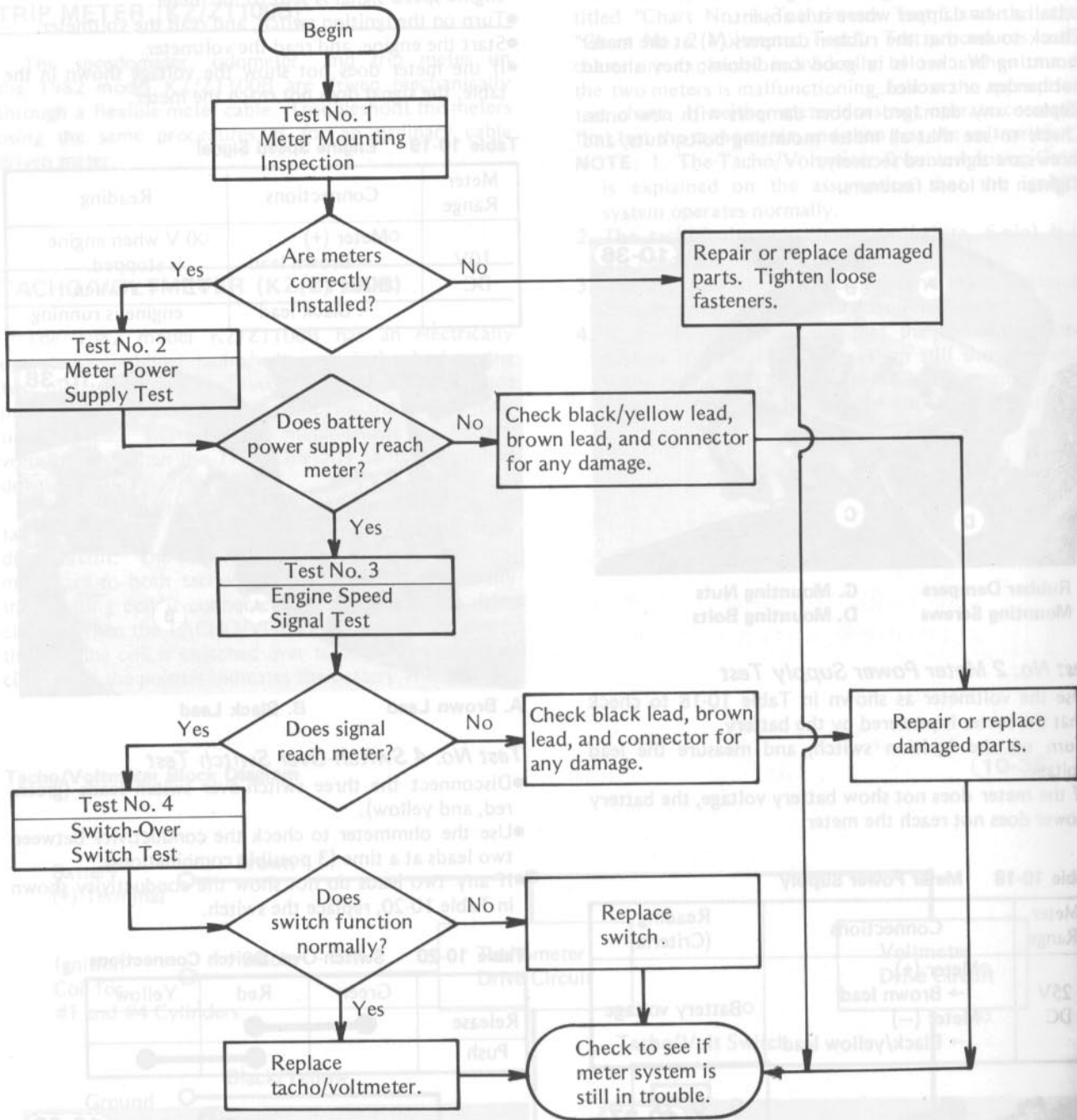

Tacho/Voltmeter  
NOTE 1. The Tacho/Voltmeter...

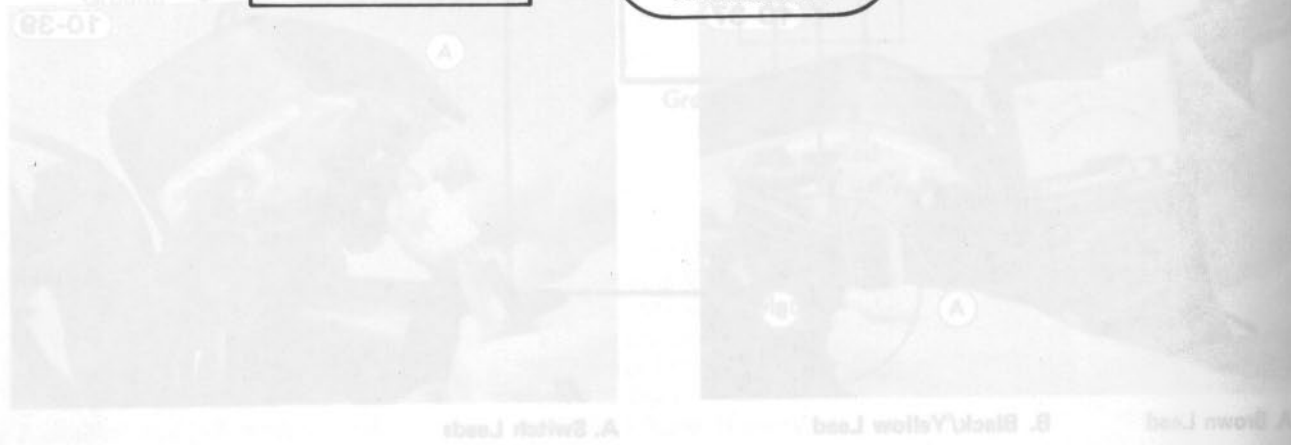
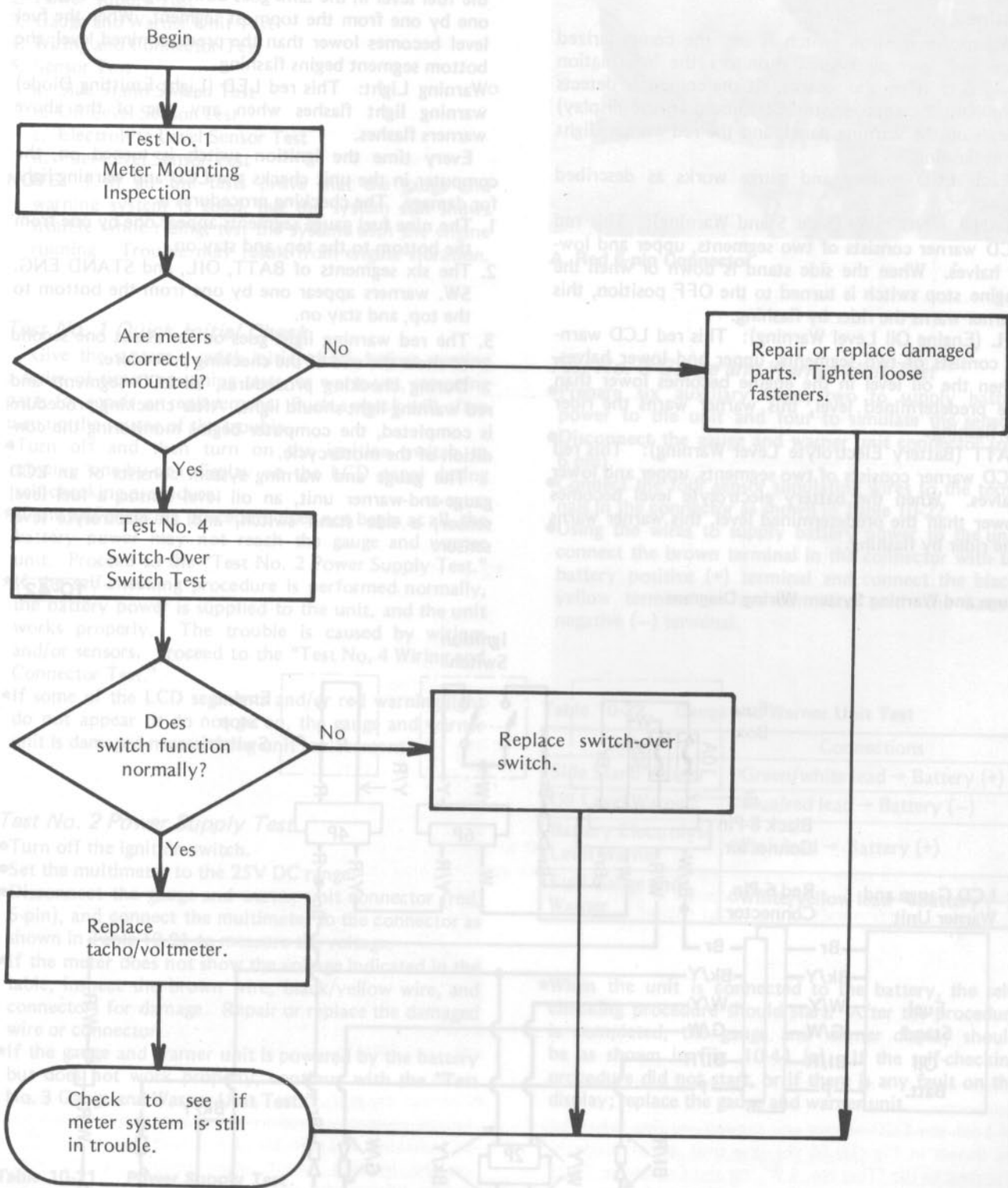

Chart No. 2 Voltmeter Test



Meter Range	+	-	+	-
25V DC	Black/yellow wire	Black/yellow wire	Black/yellow wire	Black/yellow wire

## LCD FUEL GAUGE AND WARNER UNIT (KZ/Z1100B)

### Outline:

When the ignition switch is on, the computerized gauge and warning system monitors the information provided to it by the sensors. If the computer detects a problem; the appropriate LCD (liquid crystal display) appears on the warning panel, and the red warning light begins flashing.

Each LCD warner and gauge works as described below:

- STAND, ENG. SW. (Side Stand Warning): This red LCD warner consists of two segments, upper and lower halves. When the side stand is down or when the engine stop switch is turned to the OFF position, this warner warns the rider by flashing.
- OIL (Engine Oil Level Warning): This red LCD warner consists of two segments, upper and lower halves. When the oil level in the engine becomes lower than the predetermined level, this warner warns the rider by flashing.
- BATT (Battery Electrolyte Level Warning): This red LCD warner consists of two segments, upper and lower halves. When the battery electrolyte level becomes lower than the predetermined level, this warner warns the rider by flashing.

○Fuel Gauge and Low Fuel Warning: This black LCD gauge and warner consists of nine segments in a row. When the fuel tank is full, all the segments appear. As the fuel level in the tank goes down, segments disappear one by one from the topmost segment. When the fuel level becomes lower than the predetermined level, the bottom segment begins flashing.

○Warning Light: This red LED (Light Emitting Diode) warning light flashes when any one of the above warners flashes.

Every time the ignition switch is turned on, the computer in the unit checks the LCD and warning light for damage. The checking procedure is:

1. The nine fuel gauge segments appear one by one from the bottom to the top, and stay on.
2. The six segments of BATT, OIL, and STAND ENG. SW. warners appear one by one from the bottom to the top, and stay on.
3. The red warning light goes on for about one second to show the end of the checking procedure.

During checking procedures, all LCD segments and red warning light should light. After checking procedure is completed, the computer begins monitoring the condition of the motorcycle.

The gauge and warning system consists of an LCD gauge-and-warner unit, an oil level sensor, a fuel level sensor, a side stand switch, and an electrolyte level sensor.

Gauge and Warning System Wiring Diagram

10-42

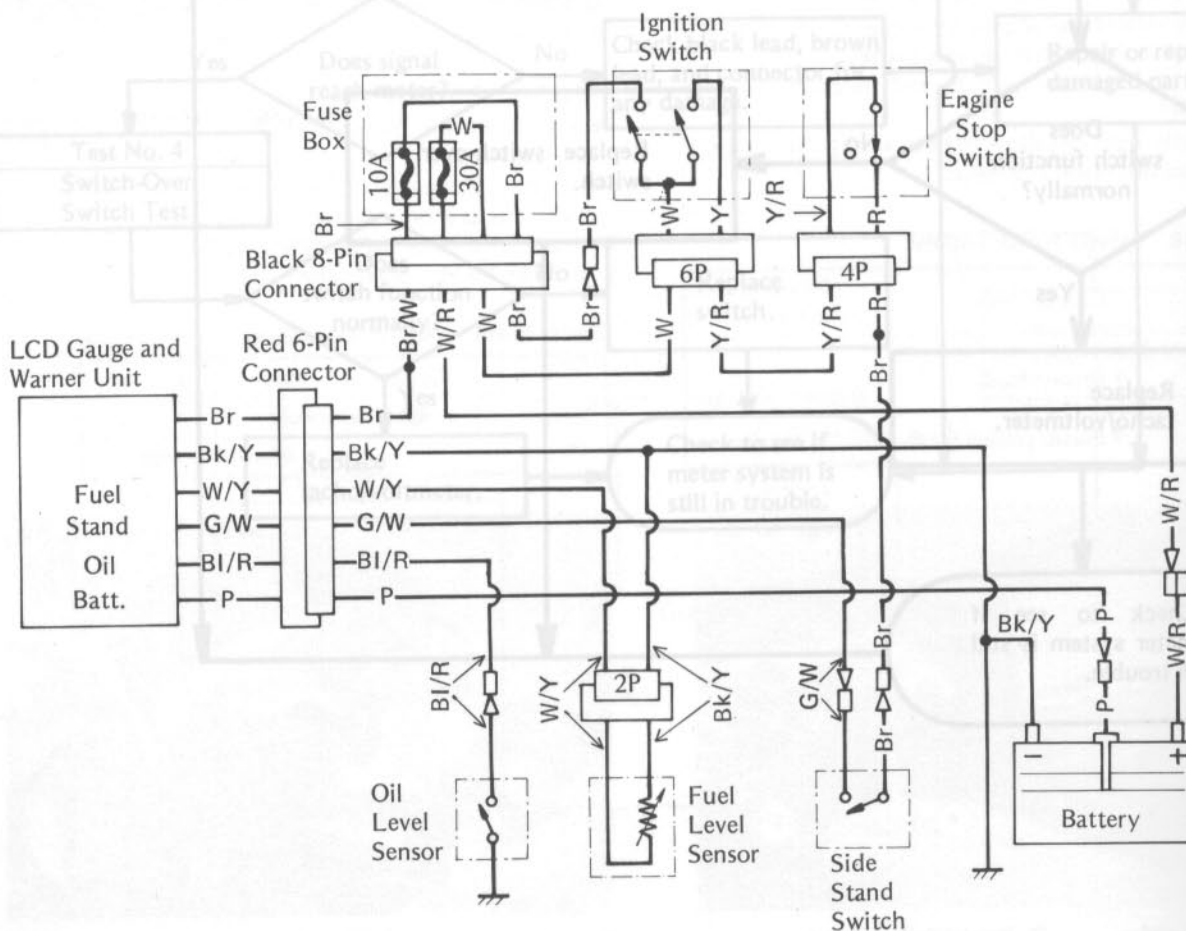

## Gauge and Warning System Troubleshooting:

Tests in this section include the following:

1. Quick Initial Check
2. Power Supply Test
3. Gauge and Warner Unit Test
4. Wiring and Connector Test
5. Sensor Test
  - a. Side Stand Switch Test
  - b. Oil Level Sensor Test
  - c. Electrolyte Level Sensor Test
  - d. Fuel Level Sensor Test

**NOTE:** 1. If all the tests prove that the gauge and warning system is good, but the system still shows trouble while riding; test the system with the engine running. Trouble may result from engine vibration.

### Test No. 1 Quick Initial Check

Give the system a quick initial check before starting a series of time consuming tests, or worse yet, removing parts for repair or replacement. Such a check will often turn up the source of the trouble.

- Turn off and then turn on the ignition switch to observe one-by-one display on the LCD panel during self-checking procedure.
- ★ If the self-checking procedure does not begin at all, the battery power may not reach the gauge and warner unit. Proceed to the "Test No. 2 Power Supply Test."
- ★ If the self-checking procedure is performed normally, the battery power is supplied to the unit, and the unit works properly. The trouble is caused by wirings and/or sensors. Proceed to the "Test No. 4 Wiring and Connector Test."
- ★ If some of the LCD segments and/or red warning light do not appear or do not go on, the gauge and warner unit is damaged necessitating unit replacement.

### Test No. 2 Power Supply Test

- Turn off the ignition switch.
- Set the multimeter to the 25V DC range.
- Disconnect the gauge and warner unit connector (red, 6-pin), and connect the multimeter to the connector as shown in Table 10-21 to measure the voltage.
- ★ If the meter does not show the voltage indicated in the table, inspect the brown wire, black/yellow wire, and connectors for damage. Repair or replace the damaged wire or connector.
- ★ If the gauge and warner unit is powered by the battery but does not work properly, continue with the "Test No. 3 Gauge and Warner Unit Test."

Table 10-21 Power Supply Test

Meter Range	Connections	Meter Reading (Criteria)
25V DC	○ Meter (+) → Brown wire	○ 0 V when ignition switch is off
	○ Meter (-) → Black/yellow wire	○ Battery voltage when ignition switch is on.

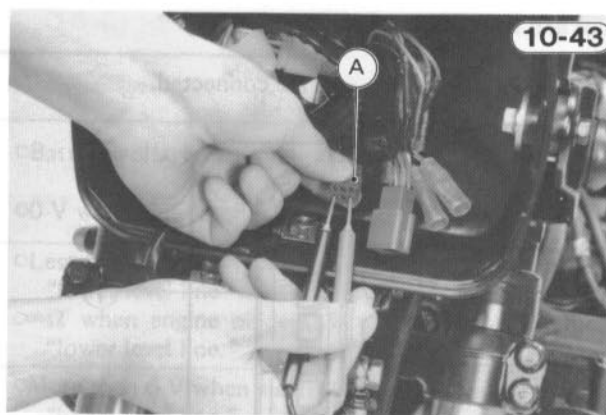

A. Red 6-pin Connector

### Test No. 3 Gauge and Warner Unit Test

- Prepare six auxiliary wires, two to supply battery power to the unit and four to simulate the sensors.
- Disconnect the gauge and warner unit connector (red, 6 pin).
- Connect the four sensor simulating wires to the terminals in the connector as shown in Table 10-22.
- Using the wires to supply battery power to the unit, connect the brown terminal in the connector with the battery positive (+) terminal and connect the black/yellow terminal in the connector with the battery negative (-) terminal.

Table 10-22 Gauge and Warner Unit Test

Circuit	Connections
Side Stand Warner	○ Green/white lead → Battery (+)
Oil Level Warner	○ Blue/red lead → Battery (-)
Battery Electrolyte Level Warner	○ Pink lead → Battery (+)
Fuel Gauge and Warner	○ White/yellow lead → Battery (-)

- ★ When the unit is connected to the battery, the self-checking procedure should start. After the procedure is completed, the gauge and warner display should be as shown in Fig. 10-44 (a). If the self-checking procedure did not start, or if there is any fault on the display; replace the gauge and warner unit.

## Gauge and Warner Unit Test

(a) All sensor-simulating wires are connected.

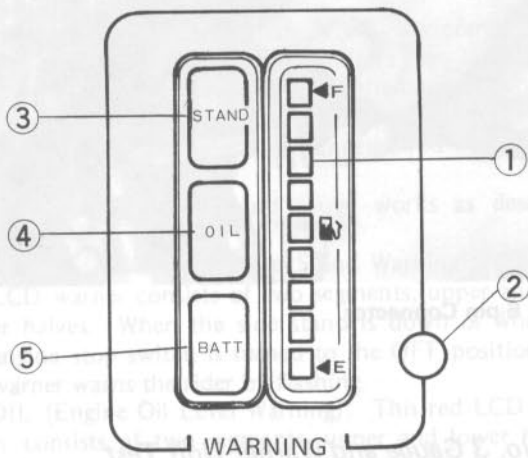

(b) Sensor-simulating wires are disconnected.

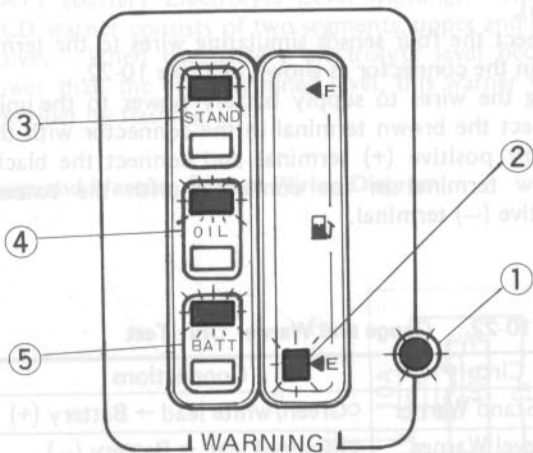

\*The time delay circuit is provided in the fuel gauge circuit to stabilize the gauge display. It takes 3 to 12 seconds for each segment to disappear or appear. Also it takes 3 to 7 seconds for the bottom segment to begin or stop flashing.

- Disconnect one of the sensor simulating wires from the connector.
- ★ If both the LCD warner and the red warning light flash as shown in Fig. 10-44 (b), the unit works properly. Proceed to the "Test No. 4 Wiring and Connector Test." If any of them does not flash, or if any of them stays on without flashing, replace the gauge and warner unit.

1. Fuel Gauge: Nine segments appear.
2. Warning Light: Unlits.
3. Side Stand Warner: Does not appear.
4. Oil Level Warner: Does not appear.
5. Battery Electrolyte Level Warner: Does not appear.

1. Warning Light: Flashes when any one of simulating wires is disconnected.
- \*2. Fuel Warner: Flashes when white/yellow wire is disconnected.
3. Side Stand Warner: Flashes when green/white wire is disconnected.
4. Oil Level Warner: Flashes when blue/red wire is disconnected.
5. Battery Electrolyte Level Warner: Flashes when pink wire is disconnected.

#### Test No. 4 Wiring and Connector Test

- Set the motorcycle on the center stand.
- Disconnect the gauge and warner unit connector (red, 6-pin).
- Connect the multimeter to the wire in the disconnected female connector (main wiring harness side connector) as indicated in Table 10-23 and read the meter. Turn on the ignition switch when testing the side stand warner wire, and make sure the engine stop switch is in the RUN position.

Wire Color	Function	Meter Range
Black/Yellow <td>Fuel Level</td> <td>0-10 V</td>	Fuel Level	0-10 V
Green/White <td>Side Stand Warner</td> <td>0-10 V</td>	Side Stand Warner	0-10 V
Blue/Red <td>Oil Level Warner</td> <td>0-10 V</td>	Oil Level Warner	0-10 V
Pink <td>Battery Electrolyte Level Warner</td> <td>0-10 V</td>	Battery Electrolyte Level Warner	0-10 V



Table 10-23 Wiring and Connector Test

Wire	Meter Range	Connections	Meter Reading (Criteria)
Side stand warner	25V DC	<ul style="list-style-type: none"> <li>○ Meter (+) → Green/white wire</li> <li>○ Meter (-) → Black/yellow wire</li> </ul>	<ul style="list-style-type: none"> <li>○ Battery voltage when side stand is up.</li> <li>○ 0 V when side stand is down.</li> </ul>
Oil level warner	$\times 10 \Omega$	<ul style="list-style-type: none"> <li>○ One meter lead → Blue/red wire</li> <li>○ Other meter lead → Black/yellow wire</li> </ul>	<ul style="list-style-type: none"> <li>○ Less than <math>0.5 \Omega</math> when engine oil level is higher than "lower level line" next to the oil level gauge.</li> <li>○ <math>\infty \Omega</math> when engine oil level is much lower than the "lower level line."</li> </ul>
Battery electrolyte level warner	10V DC	<ul style="list-style-type: none"> <li>○ Meter (+) → Pink wire</li> <li>○ Meter (-) → Black/yellow wire</li> </ul>	<ul style="list-style-type: none"> <li>○ More than 6 V when electrolyte level is higher than "lower level line."</li> <li>○ 0 V when electrolyte level is lower than "lower level line."</li> </ul>
Fuel gauge and low fuel warner	$\times 10 \Omega$	<ul style="list-style-type: none"> <li>○ One meter lead → White/yellow wire</li> <li>○ Other meter lead → Black/yellow wire</li> </ul>	<ul style="list-style-type: none"> <li>○ <math>0.5 - 118 \Omega</math></li> </ul>

★If the multimeter does not read as shown in the table, first inspect the related wire(s) and connector(s), then repair or replace the damaged part(s). If the wire(s) and connector(s) prove good, proceed to the "Test No. 5 Sensor Test."

Low Fuel Warning System

### Test No. 5 Sensor Test

#### (a) Side Stand Switch:

●For West Germany, UK, Switzerland, and Sweden: Turn off the ignition switch, and remove the fuel tank to gain access to the side stand switch leads. See the "WARNING" on Pg. 10-1.

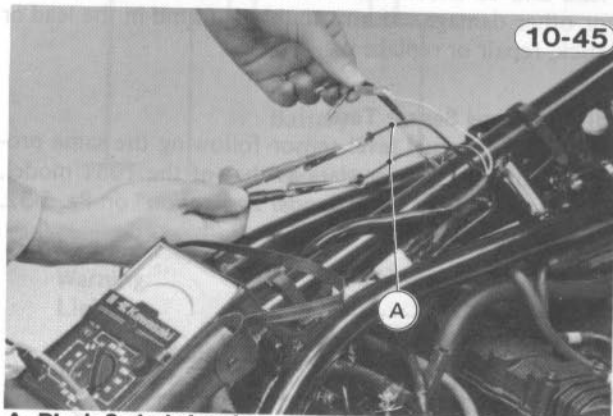

A. Black Switch Leads

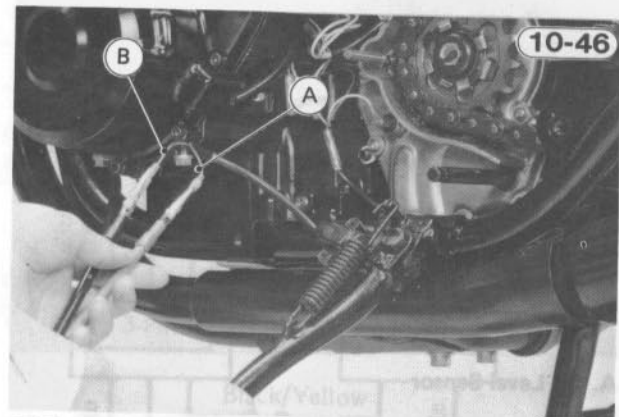

A. Brown Switch Lead B. Green/White Switch Lead

●Set the multimeter to the  $\times 1 \Omega$  range, and connect the meter to the switch leads as indicated in Table 10-24 to check the switch operation.

Table 10-24 Side Stand Switch Operation

Meter Range	Connections	Meter Reading (Criteria)
$\times 1 \Omega$	For West Germany, UK, Switzerland, and Sweden: <ul style="list-style-type: none"> <li>○ One meter lead → Black switch lead</li> <li>○ Other meter lead → Other black switch lead</li> </ul>	<ul style="list-style-type: none"> <li>○ <math>0 \Omega</math> when the side stand is in the position ① or ③ (fig. 10-47).</li> <li>○ <math>\infty \Omega</math> when the side stand is in the position ②.</li> </ul>
	For Countries other than above: <ul style="list-style-type: none"> <li>○ One meter lead → Brown switch lead</li> <li>○ Other meter lead → Green/white switch lead</li> </ul>	<ul style="list-style-type: none"> <li>○ <math>0 \Omega</math> when the side stand is up (position ③ in fig. 10-47).</li> <li>○ <math>\infty \Omega</math> when the side stand is down (positions ① and ②).</li> </ul>

Side Stand Position

10-47

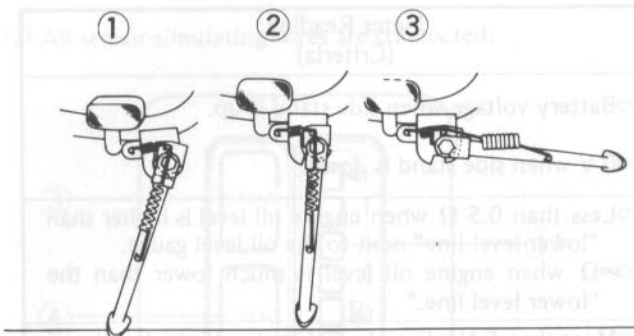

★If the meter does not read as indicated in the table, check to see that the side stand switch is properly installed on the frame. If the switch is not correctly installed, re-mount it correctly. If the switch is correctly mounted, replace the side stand switch.

(b) Oil Level Sensor Test:

- Drain the engine oil, and remove the oil level sensor.
- Connect the multimeter set to the  $\times 1 \Omega$  range as shown in Table 10-25 to check the sensor continuity.

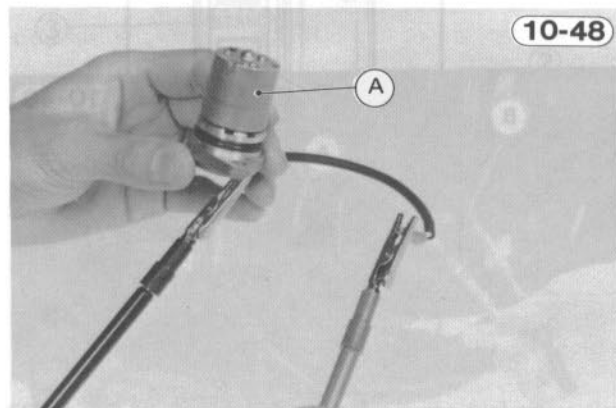

A. Oil Level Sensor

Table 10-25 Oil Level Sensor Test

Meter Range	Connections	Meter Reading (Criteria)
$\times 1 \Omega$	<ul style="list-style-type: none"> <li>○One meter lead → Sensor lead</li> <li>○Other meter lead → Sensor body</li> </ul>	<ul style="list-style-type: none"> <li>○<math>\infty \Omega</math> when sensor is held upright.</li> <li>○Less than <math>0.5 \Omega</math> when sensor is held upside down.</li> </ul>

Table 10-26 Electrolyte Level Sensor Test

Meter Range	Connections	Meter Reading (Criteria)	Inspection Items when out of Criteria
10V DC	<ul style="list-style-type: none"> <li>○Meter (+) → Sensor lead</li> <li>○Meter (-) → Chassis ground</li> </ul>	<ul style="list-style-type: none"> <li>○More than 6V</li> </ul>	<ul style="list-style-type: none"> <li>○Electrolyte level in cell in which sensor is installed.</li> <li>○Sensor lead</li> <li>○Sensor stick</li> </ul>

★The meter should read as shown in the table. If it does not, replace the oil level sensor.

(c) Electrolyte Level Sensor Test:

- Remove the seat, and remove the air cleaner housing.
- Disconnect the sensor pink lead.
- Connect the multimeter set to the 10V DC range as shown in Table 10-26 to check the sensor lead voltage.

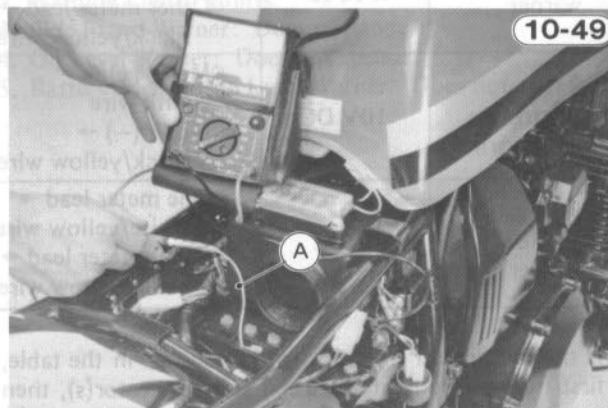

A. Electrolyte Level Sensor Lead

★If the voltage is lower than the value in the table, first check the electrolyte level in the cell where the sensor is installed. If the level is lower than the lower level line, add distilled water. If the level is high enough, remove the sensor from the battery to check for an open lead and to check the sensor lead stick for corrosion or other damage. If any trouble is found in the lead or stick, repair or replace it.

(d) Fuel Level Sensor Test:

Inspect the fuel level sensor following the same procedure and the service data as that of the 1981 model. Refer to the "Fuel Level Sender Inspection" on Pg.5-32.

## LOW FUEL WARNING SYSTEM (KZ1000M)

This is a system that warns the rider when the fuel level in the tank becomes low. It consists of a fuel level sensor inside the tank, a warning light, and an electronic self-checker to check the bulb for blown filament.

When the ignition switch is first turned on, the warning light comes on immediately and then goes off after about 3 seconds. This is done by the self-checker to show that the bulb is not burned out, and the light will come on and go off regardless of the amount of fuel in the tank.

Then after about 3 minutes (depending on outside temperature and the condition of the battery), if the fuel level is low, the light will come back on and stay on continuously until fuel is added.

### Warning System Trouble

Before starting to troubleshoot the fuel warning system, first check that the battery is good and make sure that all connectors in the system are clean and tight.

(1) The Warning light does not come on when the switch is first turned on.

- Check that the bulb itself is good.
- Remove the right side cover and disconnect the 3-pin connector for the self-checker.
- Using the 25V DC or higher range of the meter,

### Low Fuel Warning System

connect the + meter lead to the brown wire and the - meter lead to the black/yellow wire of the connector to check the battery power supply.

- Turn the ignition switch on and see if the meter reads battery voltage.
  - ★ If the meter does not read battery voltage, the wiring is at fault.
  - ★ If the meter does read battery voltage, plug the connector back in securely and check again whether the light comes on. If it still does not, the self-checker is bad and must be replaced.
- (2) Fuel level is low but the warning light does not come on.
- Check that the warning light comes on when the ignition switch is first turned on (See Problem 1 above).
  - Disconnect the 3-pin connector to the fuel level sensor, set the meter to the 25V DC or higher range, and connect the + meter lead to the green/white wire and the - lead to the black/yellow wire.
  - Turn on the ignition switch and read the meter.
  - ★ If the meter does not read battery voltage, the wiring is at fault.
  - ★ If it does read battery voltage, the sensor is defective.
- (3) Fuel level is not low but the warning light stays on continuously.
- Remove the right side cover, and disconnect the 3-pin connector to the self-checker.
  - ★ Now turn on the ignition switch. If the light still

10-50

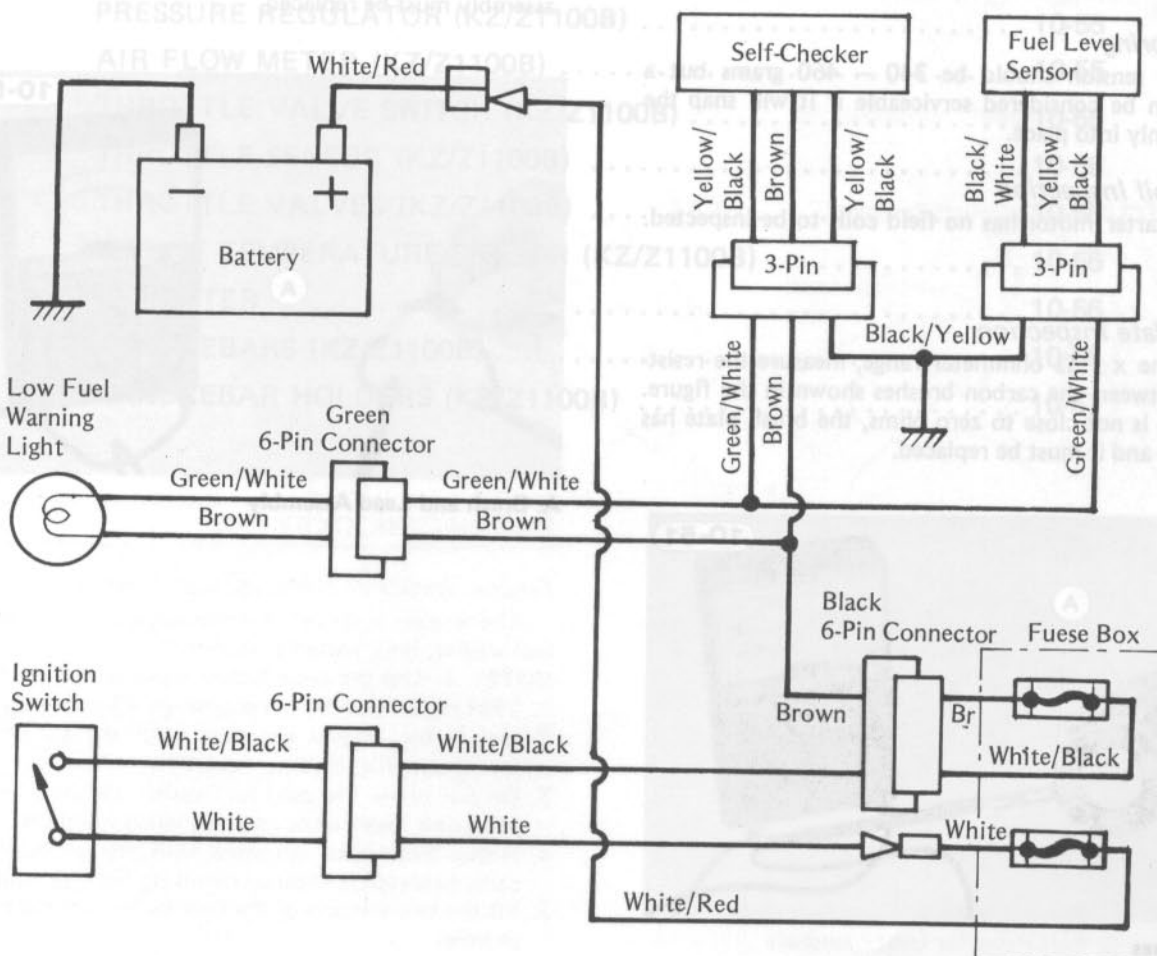

- comes on, the sensor is bad. If the light stays off now, the self-checker is bad and must be replaced.
- (4) Warning light goes on and off irregularly.
- Check that the fuel is well above the low level.
  - Check that the wiring is not shorting out against other parts.
  - Check that the regulator/rectifier output voltage is normal (Pg. 5-6).
  - ★ If all the above checks are good, unplug the self-checker. If the problem disappears, the self-checker is bad and must be replaced. If the problem persists, recheck the wiring and check that the sensor is not internally shorting intermittently.

## ELECTRIC STARTER SYSTEM

Refer to Pgs. 5-15 through 5-19, noting the following:

### Starter Motor:

The starter motor on the 1982 KZ/Z1000J, K, M and KZ/Z1100B has the permanent magnets in the yoke instead of the field coils.

### Brush Spring

Spring tension should be 340 — 460 grams but a spring can be considered serviceable if it will snap the brush firmly into place.

### Field Coil Inspection

The starter motor has no field coils to be inspected.

### Brush Plate Inspection

- Using the  $\times 1 \Omega$  ohmmeter range, measure the resistance between the carbon brushes shown in the figure.
- ★ If there is not close to zero ohms, the brush plate has an open and it must be replaced.

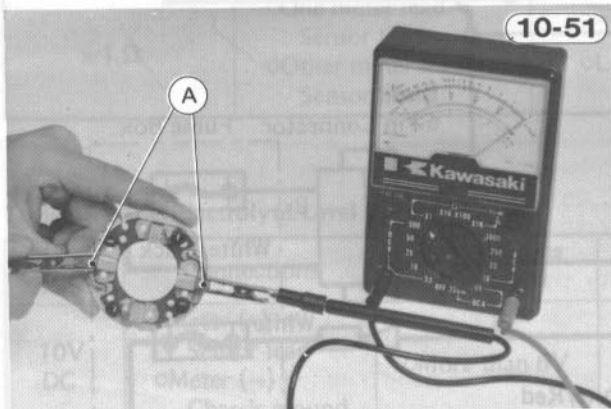

A. Brushes

- Using the highest ohmmeter range, measure the resistance between the metal plate and the brush holders shown in the figure.
- ★ If there is any reading at all, the brush holder has a short and the brush plate must be replaced.

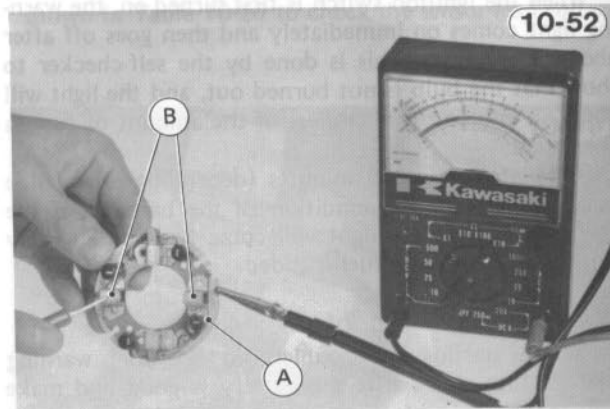

A. Metal Plate

B. Brush Holders

### Brush and Lead Assembly Inspection

- Using the  $\times 1 \Omega$  ohmmeter range, measure the resistance between the brushes.
- ★ If there is a high resistance or no reading ( $\infty$ ) between the brushes, a lead is open and the brush and lead assembly must be replaced.

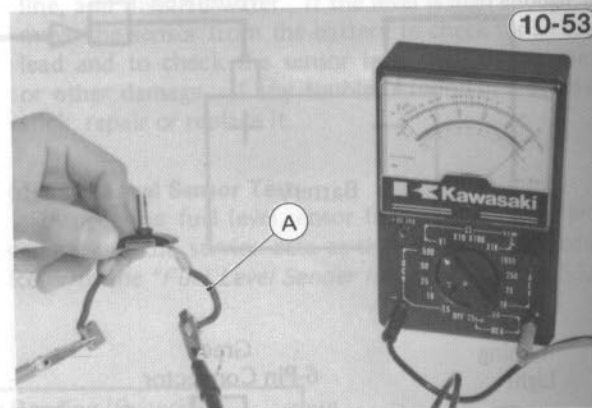

A. Brush and Lead Assembly

# Disassembly

## Table of Contents

### STARTER MOTOR

10-52

### Starter Motor Disassembly and Assembly

#### NOTE

CAMSHAFTS (KZ/Z1100B) .....	10-52
CAMSHAFT SPROCKETS (KZ/Z1100B) .....	10-52
CLUTCH RELEASE .....	10-52
ENGINE SPROCKET .....	10-52
STARTER MOTOR .....	10-53
ENGINE OIL LEVEL SENSOR (KZ/Z1100B) .....	10-55
CRANKCASE SPLIT .....	10-55
PRESSURE REGULATOR (KZ/Z1100B) .....	10-55
AIR FLOW METER (KZ/Z1100B) .....	10-55
THROTTLE VALVE SWITCH (KZ/Z1100B) .....	10-55
THROTTLE SENSOR (KZ/Z1100B) .....	10-56
THROTTLE VALVES (KZ/Z1100B) .....	10-56
ENGINE TEMPERATURE SENSOR (KZ/Z1100B) .....	10-56
IC IGNITER .....	10-56
HANDLEBARS (KZ/Z1100B) .....	10-56
HANDLEBAR HOLDERS (KZ/Z1100B) .....	10-57

**CAMSHAFTS (KZ/Z1100B)  
CAMSHAFT SPROCKETS (KZ/Z1100B)**

Refer to Pgs. 6-18 through 6-21, noting the following exceptions:

*Camshaft and Sprocket Removal and Installation*

- NOTE:** 1. The camshafts and sprockets for the 1982 model KZ/Z1100B are different from the previous year model. The same sprockets and camshafts are used for the inlet and exhaust camshafts.
2. For exhaust use, use the two bolt holes in the circle recesses; for inlet use, two bolt holes in the hexagonal recesses.

**1982 KZ/Z1100B's Camshaft Identification Mark** 10-54

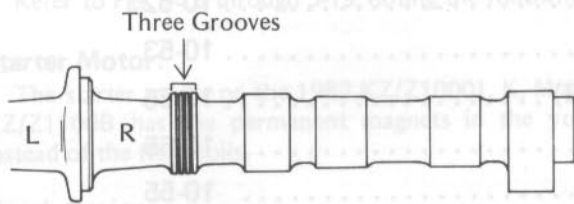

**1982 KZ/Z1100B's Camshaft Sprocket** 10-55

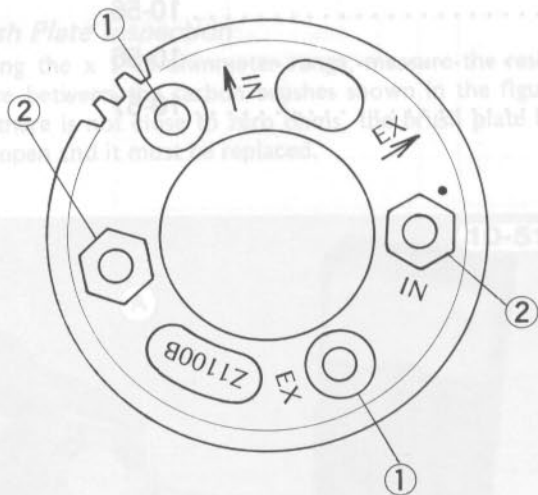

- 1. Bolt Holes for Exhaust Camshaft
- 2. Bolt Holes for Inlet Camshaft

**CLUTCH RELEASE**

Refer to Pg. 6-28 and 6-31 noting the following:

*Clutch Release Removal and Installation*

- NOTE:** 1. The clutch release for the 1982 model KZ/Z1000J, K, M, and KZ/Z1100B is of a ball-cam type.
2. Install the adjusting screw ② and ball ramp plate ③, aligning the ridge on the engine sprocket cover with the groove in the ball ramp plate.

**Clutch Release**

10-56

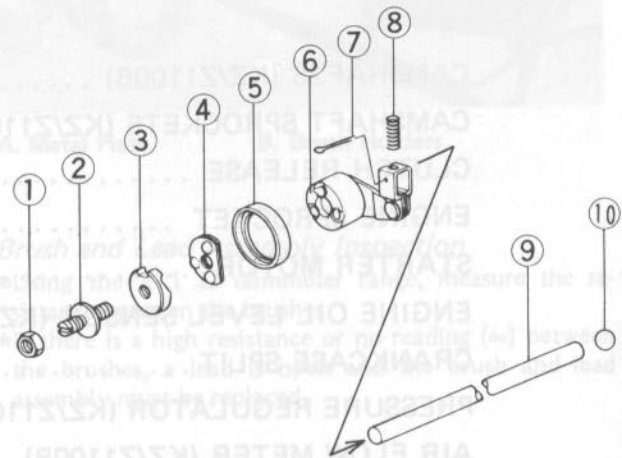

- 1. Locknut
- 2. Adjusting Screw
- 3. Ball Ramp Plate
- 4. Ball Assembly
- 5. Grease Seal
- 6. Release Lever
- 7. Cotter Pin
- 8. Spring
- 9. Push Rod
- 10. Steel Ball

3. Clutch adjusting procedure differs from that of the 1981 model. See Pg. 10-18.

**ENGINE SPROCKET**

*Engine Sprocket Removal and Installation*

The engine sprocket is installed with a flat washer, lockwasher, bolt, and stop washer.

- NOTE:** 1. Use the same holder (special tool) as for the 1981 model to hold the engine sprocket steady.
2. Install the engine sprocket with the "O.S" mark facing out (Fig. 6-95 on Pg. 6-31).
3. Do not re-use the used lockwasher and bolt. Always use a new lockwasher and bolt when installing.
4. A new lockwasher is coated with anti-corrosive lubricant, so install it without removing the lubricant.
5. Fit the two tongues of the lockwasher into the sprocket holes.

6. Tightening torque for the bolt is 8.0 kg-m (58 ft-lbs).  
 It is not required to apply a molybdenum disulfide engine assembly grease to the threads of the bolt.
7. After tightening the bolt, install the stop washer so that the short tabs of the lockwasher are between the stop tabs of the stop washer, and bend the four long tabs of the lockwasher over the stop washer with a hammer. Do not use a screw driver, chisel or any other tool having a sharp edge.

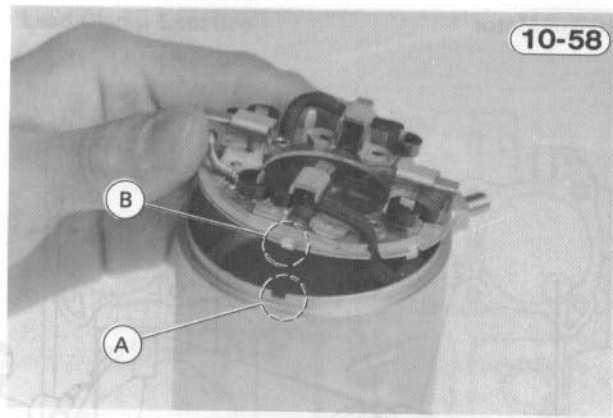

10-58

A. Notch                      B. Tongue

**STARTER MOTOR**

Refer to Pgs. 6-35 and 6-36, noting the following:

**Starter Motor Disassembly and Assembly**

- NOTE:** 1. The starter motor of the 1982 models has the permanent magnets in the yoke instead of the field coils.
2. Tightening torque for the terminal nut is 1.1 kg-m (95 in-lbs).
  3. Align the brush plate tongue with the yoke notch.

- NOTE:** 1. The engine oil level sensor is installed in the oil pan. Drain the engine oil before sensor removal, and fill the engine with oil after sensor installation.
2. Remove the bolts (2) and pull the sensor downward to remove it from the engine.
  3. Position the sensor so that the sensor lead comes to the left side of the engine.

**Engine Sprocket Installation**

(a) Required Parts

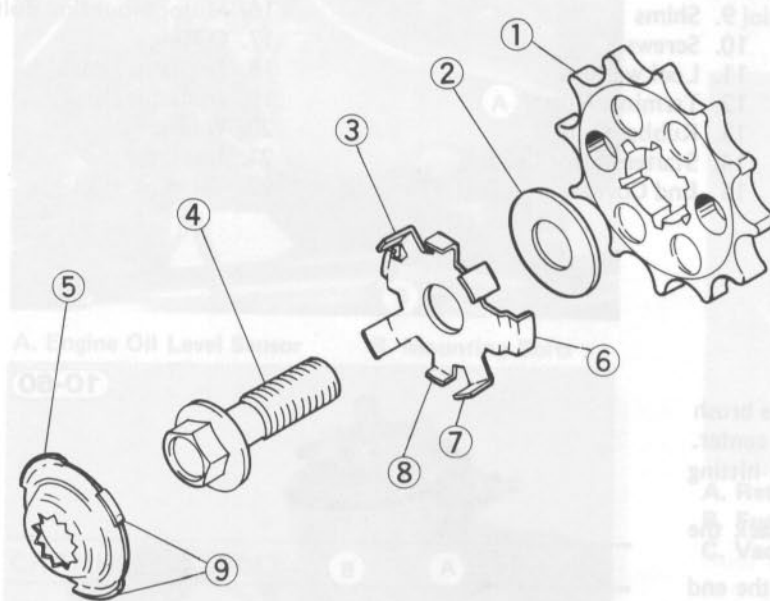

(b) Installation Completed

Bend four long tabs

1. Engine Sprocket
2. Flat Washer
3. Lockwasher
4. Bolt
5. Stop Washer
6. Tongue x 2
7. Long Tab x 4
8. Short Tab x 2
9. Stop Tab x 4

**PRESSURE REGULATOR (RZ/Z1100)**

Removal and Installation

10-57

- NOTE:** 1. The pressure regulator is led to the #1 and #4 fuel lines via the 3-way joint (4-way joint for the 1982 models).

**AIR FLOW METER THROTTLE VALVE SWITCH (RZ/Z1100)**

An air flow meter and a throttle valve switch are not used for the DFI system.

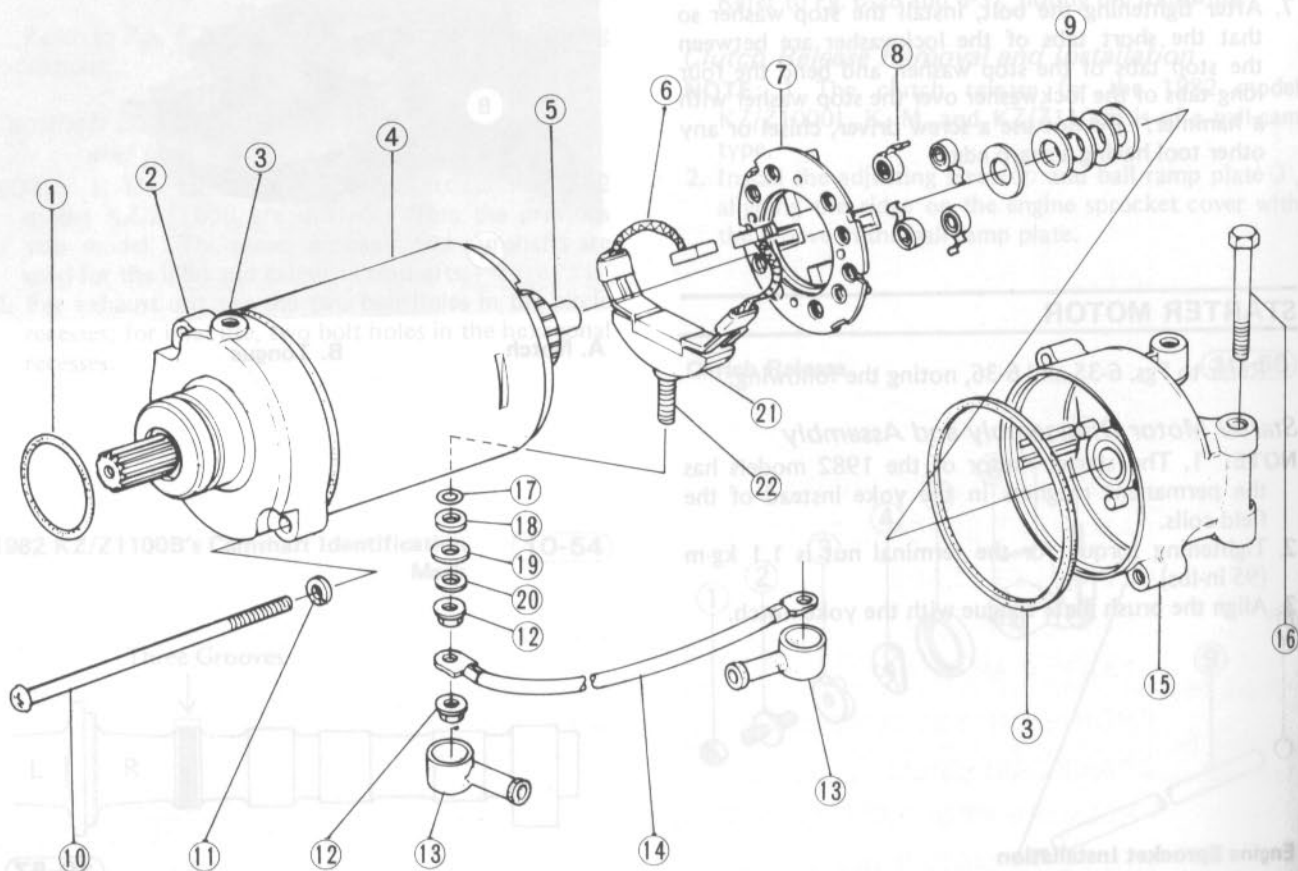

- 1. O-Ring
- 2. End Cover
- 3. O-Rings
- 4. Yoke
- 5. Armature
- 6. Brush and Lead Assembly
- 7. Brush Plate
- 8. Brush Springs

- 9. Shims
- 10. Screws
- 11. Lockwashers
- 12. Terminal Nuts
- 13. Rubber Caps
- 14. Starter Motor Lead

- 15. End Cover
- 16. Motor Mounting Bolts
- 17. O-Ring
- 18. Insulator (small)
- 19. Insulator (large)
- 20. Washer
- 21. Insulator
- 22. Terminal Bolt

4. Armature Installation:

- Push the brushes into the brush holder until the brush spring does not snap the brush back towards the center. This prevents the armature commutator from hitting the brushes during armature installation.
  - After installing the armature in place, push back the brushes to the correct position.
5. Fit the long tongue of the brush plate into the end plate groove.

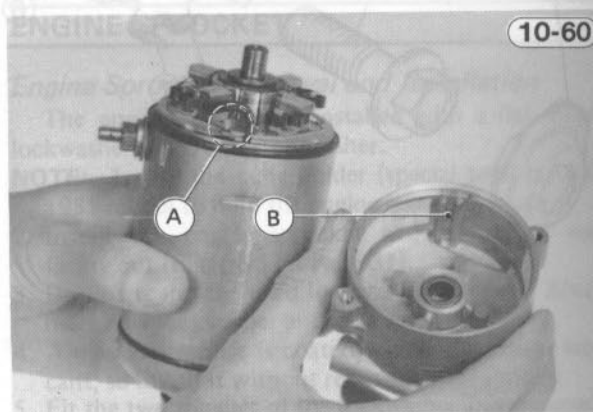

A. Tongue

B. Groove



6. Check to see that the line on the end cover is aligned with the line on the yoke.

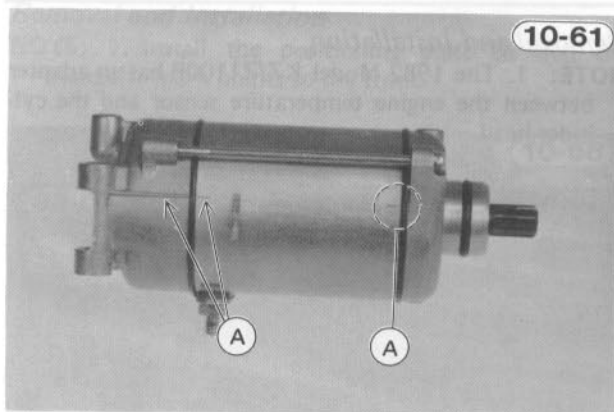

10-61

A. Align the lines.

### ENGINE OIL LEVEL SENSOR (KZ/Z1100B)

#### Sensor Removal and Installation

- NOTE:** 1. The engine oil level sensor is installed at the oil pan. Drain the engine oil before sensor removal, and fill the engine with oil after sensor installation.
- Remove the bolts (2), and pull the sensor downward to remove it from the engine.
  - Position the sensor so that the sensor lead comes to the left side of the engine.

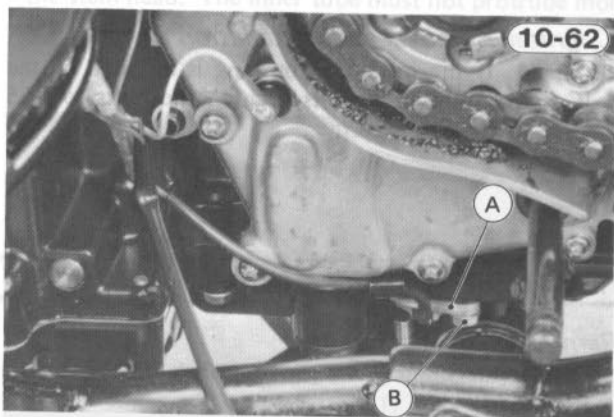

10-62

A. Engine Oil Level Sensor

B. Mounting Bolts

### CRANKCASE SPLIT

Refer to Pgs. 6-44 through 6-46, noting the following exception.

#### Crankcase Splitting and Assembly

- NOTE:** 1. Lead clamp location is changed as shown in (3) the figure.

### Lead Clamp Location

10-63

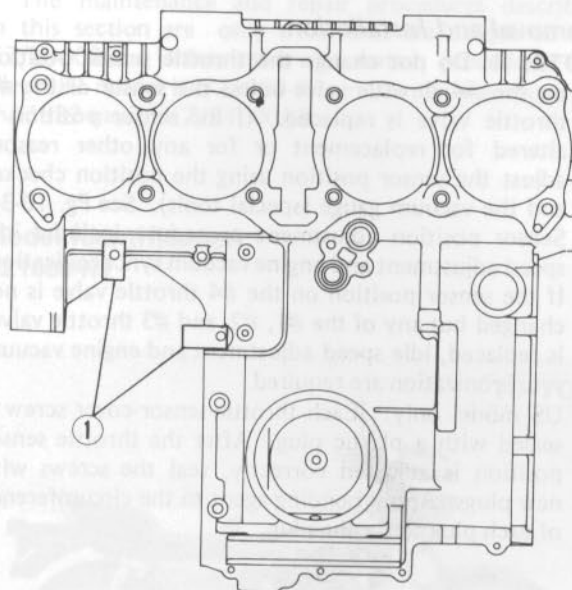

1. Lead Clamps

### PRESSURE REGULATOR (KZ/Z1100B)

#### Removal and Installation

- NOTE:** 1. The vacuum hose for the pressure regulator is led to the #1 and #4 throttle valves via the 3-way joint (4-way joint for the US model).

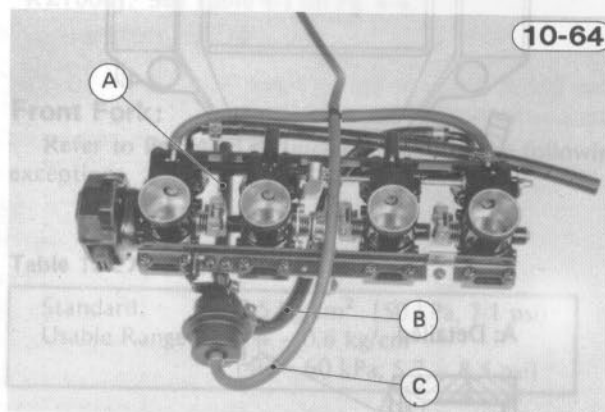

10-64

A. Return Fuel Hose (to fuel tank)

B. Fuel Hose (from distributing pipe)

C. Vacuum Hose

### AIR FLOW METER (KZ/Z1100B) THROTTLE VALVE SWITCH (KZ/Z1100B)

An air flow meter and a throttle valve switch are not used for the DFI system.

## THROTTLE SENSOR (KZ/Z1100B) THROTTLE VALVES (KZ/Z1100B)

### Removal and Installation

- NOTE:** 1. Do not change the throttle sensor position on the #4 throttle valve unless the sensor or the #4 throttle valve is replaced. If the sensor position is altered for replacement or for any other reason, adjust the sensor position using the position checker and the vacuum gauge (special tools). See Pg. 10-34. Sensor position adjustment procedure includes idle speed adjustment and engine vacuum synchronization.
2. If the sensor position on the #4 throttle valve is not changed but any of the #1, #2, and #3 throttle valves is replaced, idle speed adjustment and engine vacuum synchronization are required.
3. US model only: Each throttle-sensor-cover screw is sealed with a plastic plug. After the throttle sensor position is adjusted correctly, seal the screws with new plugs. Apply bonding agent to the circumference of each plug to fix the plug.

### Seal Plug Installation (US model)

10-65

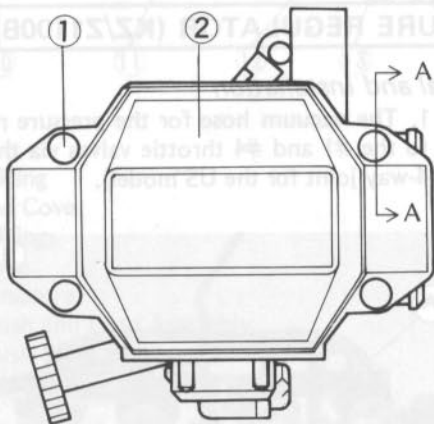

#### A: Detailed

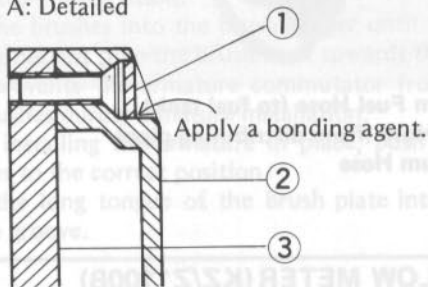

1. Seal Plugs
2. Sensor Cover
3. Mounting Bracket

## ENGINE TEMPERATURE SENSOR (KZ/Z1100B)

### Removal and Installation

- NOTE:** 1. The 1982 Model KZ/Z1100B has an adapter between the engine temperature sensor and the cylinder head.

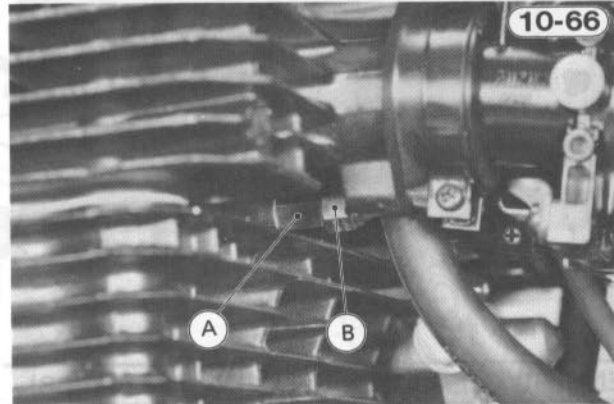

A. Adapter

B. Engine Temperature Sensor

## IC IGNITER

Refer to Pg. 7-26, noting the following:

### IC Igniter Removal and Installation

- NOTE:** 1. If the insulation bushing is installed on the IC igniter mounting bolts, tighten the bolts to 0.65 kg-m (56 in-lbs) of torque.

## HANDLEBARS (KZ/Z1100B)

### Removal and Installation

- NOTE:** 1. Tightening torque for the handlebar clamp bolts is 2.5 kg-m (18.0 ft-lbs).

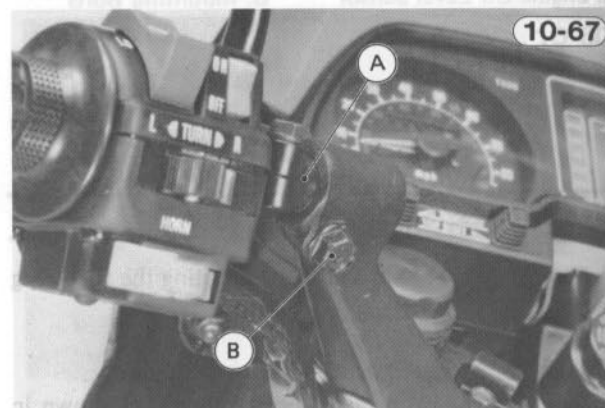

A. Handlebar

B. Clamp Bolt

## HANDLEBAR HOLDERS (KZ/Z1100B)

### Removal and Installation

**NOTE:** 1. Install the positioning plate so that the triangular mark points to the front.

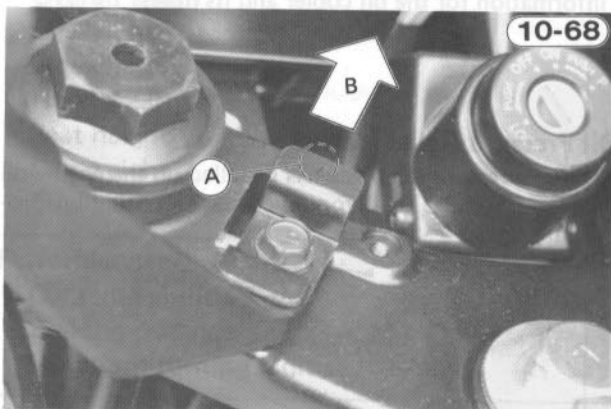

A. Triangular Mark      B. Front

2. The handlebar holder spacer must be compressed between the handlebar holder and the stem head without no play. So install the holder using the following four steps:

- Loosen the front fork clamp bolts (3 on each side) and slide the fork inner tube down so that the inner tube upper end protrudes 1 mm from the upper surface of the stem head. The inner tube must not protrude more than the spacer thickness.

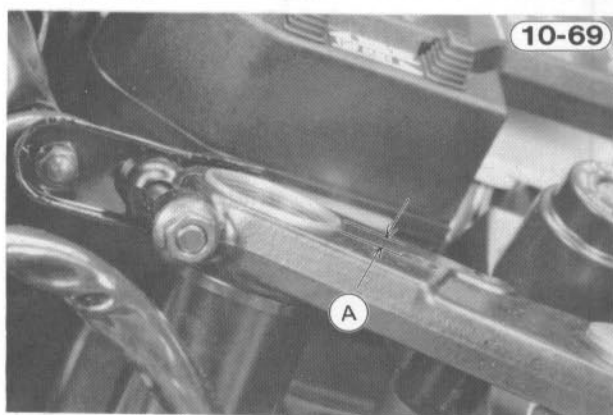

A. 1 mm

- Lightly tighten the front fork upper clamp bolt to give friction to the inner tube. Leave the lower clamp bolts loose.
- Install the spacer, handlebar holder, and positioning plate, and handtighten the positioning plate bolt and the holder bolt.
- Tighten the bolts in the following sequence.
  - (1) Holder Bolt — 7.5 kg-m (54 ft-lbs)
  - (2) Fork Clamp Bolts (3) — 1.8 kg-m (13.0 ft-lbs)
  - (3) Positioning Plate Bolt

## KZ/Z1000-R1 SERVICE INFORMATION

The maintenance and repair procedures described in this section are only those that are unique to the KZ/Z1000R. Unless otherwise noted, procedures for the 1982 model KZ/Z1000-R1 are the same as those for the 1982 model KZ/Z1000-J2.

### Model Identification: KZ1000-R1



### Tires:

- The front and rear tires are the same as those for the KZ/Z1100B. See Pg. 10-7.
- For both KZ1000R and Z1000R, inflate the tires to the same air pressure specified for the US model KZ1000J. See Table 4-1 on Pg. 4-4.

### Front Fork:

Refer to Pgs. 4-13 through 4-15, noting the following exception:

**Table 10-27 Front Fork Air Pressure**

Standard:	0.5 kg/cm <sup>2</sup> (50 kPa, 7.1 psi)
Usable Range:	0.4 – 0.6 kg/cm <sup>2</sup> (40 – 60 kPa, 5.7 – 8.5 psi)

### Rear Shock Absorbers: Spring Adjustment

The spring pre-load on each rear shock absorber can be adjusted for different road and loading conditions. If the spring action feels too soft or too stiff, adjust position of both adjusting nuts in accordance with the following procedure:

- Using the hook wrenches, loosen the locknut and turn the adjusting nut as required.

- Adjust the spring by turning the adjusting nut counter-clockwise to get more soft or clockwise to get more hard.
- Tighten the locknut.

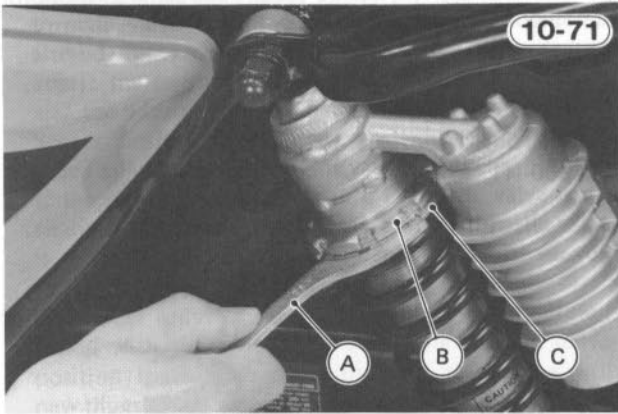

A. Hook Wrench  
B. Looknut  
C. Adjusting Nut

**WARNING** 1. If both spring adjusting nuts are not adjusted equally, handling may be impaired and a hazardous condition may result.

**Scrapping:**

- WARNING** 1. Since the rear shock absorber contains nitrogen gas, do not incinerate or disassemble the rear shock absorber.
2. Before a rear shock absorber is scrapped, pry open the cap at the bottom of the air chamber and release the nitrogen gas completely through the air valve.

Rear Shock Absorber Spring Force (per one shock absorber unit)

10-72

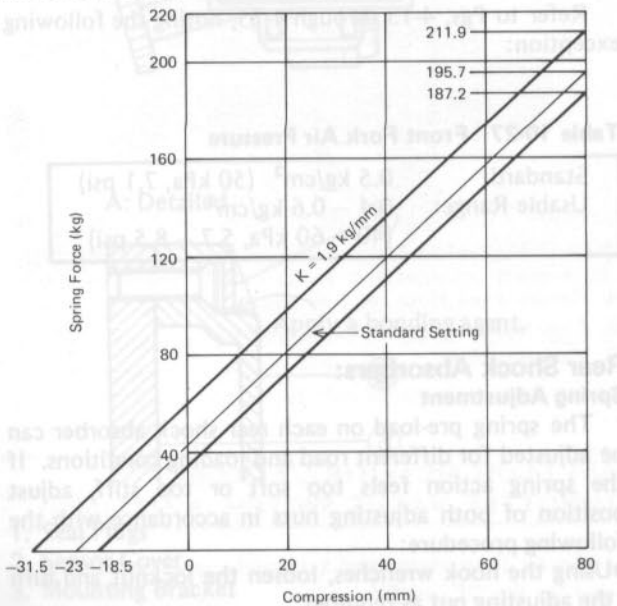

**Oil Cooler:**

- The oil cooler is equipped in the engine lubrication system. So the additional 0.2 liter of engine oil will be required for oil cooler and hoses if the oil is completely drained.
- Refer to Pgs. 9-33 and 9-34 for removal and installation information for the oil cooler and its hoses.

**Oil Pressure Relief Valve:**

- The oil pressure relief valve is installed on the engine oil pump. See Pg. 9-34 for relief valve installation procedure.

## KZ/Z1000-R1 Specifications:

Items	KZ/Z1000-R1
<b>Dimensions:</b>	
Overall length	2,240 mm
Overall width	820 mm
Overall height	1,230 mm
Wheelbase	1,525 mm
Road clearance	120 mm
Seat height	775 mm
Dry weight	222 kg
Fuel tank capacity	21.4 liters
<b>Performance:</b>	
Climbing ability	30°
Braking distance	12.5 m from 50 kph
Minimum turning radius	2.5 m
<b>Engine:</b>	
Type	4-stroke, DOHC, 4-cylinder
Cooling system	Air cooled
Bore and stroke	69.4 x 66.0 mm
Displacement	998 cc
Compression ratio	9.2
Maximum horsepower	102HP @8,500 rpm
Maximum torque	9.3 kg-m @7,000 rpm
Valve timing:	
Inlet	Open
	Close
	Duration
Exhaust	Open
	Close
	Duration
Carburetion system	Mikuni carburetors, BS34 x 4
Cylinder numbering method	Left to right, 1-2-3-4
Firing order	1-2-4-3
Lubrication system	Forced lubrication (Wet sump)
Engine oil:	
Grade	SE class
Viscosity	SAE 10W40, 10W50, 20W40, or 20W50
Capacity	3.7 liters
Starting system	Electric starter
Ignition system	Battery and coil (Transistorized)
Timing advance	Mechanically advanced
Ignition timing	From 10° BTDC @1,000 rpm to 40° BTDC @3,400 rpm
Spark Plug	NGK B8ES or ND W24ES-U

Items	KZ/Z1000-R1
<b>Drive Train:</b>	
Primary reduction system:	
Type	Gear
Reduction ratio	1.732 (97/56)
Clutch type	Wet multi disc
Transmission:	
Type	5-speed, constant mesh, return shift
Gear ratios	2.642 (37/14)
	1.833 (33/18)
	1.428 (30/21)
	1.173 (27/23)
	1.040 (26/25)
Final drive system:	
Type	Chain drive
Reduction ratio	2.733 (41/15)
Overall drive ratio	4.923 @Top gear
<b>Frame:</b>	
Type	Tubular, double cradle
Castor (rake angle)	29°
Trail	115 mm
Front tire:	
Type	Tubeless
Size	100/90V 19
Rear tire:	
Type	Tubeless
Size	120/90V 18
Front suspension:	
Type	Telescopic fork (Pneumatic)
Wheel travel	145 mm
Rear suspension:	
Type	Swing arm
Wheel travel	100 mm
Brake type:	
Front	Dual disc brake
Rear	Signal disc brake
<b>Electrical Equipment:</b>	
Alternator:	
Type	Three-phase AC
Rated output	20 amp. @8,000 rpm, 14V
Voltage regulator	Short-circuit type
Battery	12V 18AH
Headlight:	
Type	Sem-sealed
Bulb	12V 60/55W (Quartz-halogen)
Tail/brake light	12V 8/27W x 2



Z1000-R1 Wiring Diagram

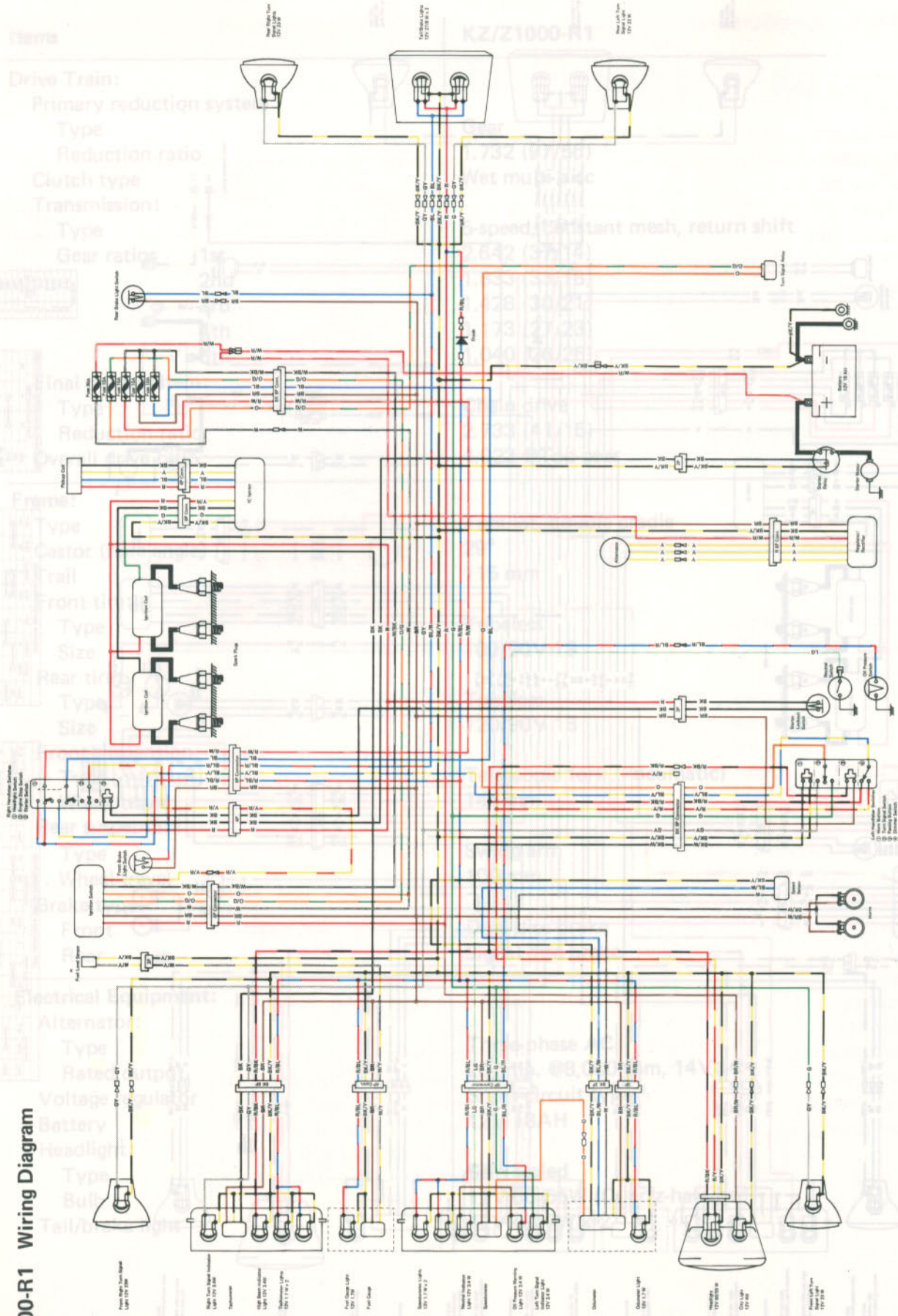

Color	Wire
BL	Black
BR	Brown
BU	Blue
GY	Gray
GN	Green
OR	Orange
PK	Pink
RD	Red
SL	Silver
WH	White

Color	Wire
BL	Black
BR	Brown
BU	Blue
GY	Gray
GN	Green
OR	Orange
PK	Pink
RD	Red
SL	Silver
WH	White

Color	Wire
BL	Black
BR	Brown
BU	Blue
GY	Gray
GN	Green
OR	Orange
PK	Pink
RD	Red
SL	Silver
WH	White

Color	Wire
BL	Black
BR	Brown
BU	Blue
GY	Gray
GN	Green
OR	Orange
PK	Pink
RD	Red
SL	Silver
WH	White



# Supplement – 1983 Model

This 11th chapter "Supplement – 1983 Model" is designed to be used in conjunction with the front part of this manual (up to the end of the 10th chapter). The maintenance and repair procedures described in this chapter are only those that are unique to the 1983 models. Complete and proper servicing of the 1983 models therefore requires mechanics to read both this chapter and the text in front of this chapter.

## Table of Contents

Safety Awareness .....	11-2
List of Abbreviations .....	11-2
<b>General Information</b>	
Model Identification .....	11-3
Specifications (KZ/Z1000-J3) .....	11-4
Specifications (KZ/Z1000-R2) .....	11-7
Service Data .....	11-10
KZ1000-J3/R2 Wiring Diagram .....	11-11
Z1000-J3/R2 Wiring Diagram .....	11-12
<b>Scheduled Maintenance</b>	
Periodic Maintenance Chart .....	11-13
<b>Non-scheduled Maintenance</b>	
Fuel Gauge (KZ/Z1000R/J) .....	11-14
Speedometer (KZ/Z1000R/J) .....	11-14
Odometer (KZ/Z1000R/J) .....	11-14
Trip Meter (KZ/Z1000R/J) .....	11-14
Rear Shock Absorbers (KZ/Z1000R/J) .....	11-14
<b>Disassembly</b>	
Carburetors (KZ/Z1000R/J) .....	11-15
Camshafts (KZ/Z1000R/J) .....	11-15
Camshaft Sprockets (KZ/Z1000R/J) .....	11-15
Engine Sprocket (KZ/Z1000R/J) .....	11-15
<b>Appendix</b>	
Unit conversion Table .....	11-16

---

**Service Data**

---

**Cam shaft (KZ/Z1000R):****Cam Height:**

- The inlet and exhaust camshafts for the 1983 model KZ/Z1000R are the same parts as those for the 1982 model KZ/Z1100B. See p. 10-7 for the cam height data.

**Wheels:****Front Tire (Z1000R):**

Standard tire:	3.25V19 4PR Tubeless Dunlop K300MA
----------------	--

**Rear Tire (Z1000J):**

Standard tire:	4.25V19 4PR Tubeless Dunlop K300
----------------	--

**Carburetors (KZ/Z1000J and KZ/Z1000R):****KZ/Z1000J Carburetor Specifications:**

Type:	BS34
Main jet:	117.5R
Needle jet:	Y-2
Jet needle:	US model 5CF59
Other than US 5CF58	
Jet needle clip position (Other than US):	3rd groove from top
Pilot jet:	37.5
Starter jet:	Jet 1:45, Jet 2:φ0.8
Main air jet:	85
Pilot air jet:	350
Pilot screw:	US model Non-adjustable
Other than US 2.0 turns out	
Service fuel level:	3 ± 1 mm
Float height:	18.6 mm

**KZ/Z1000R Carburetor Specifications:**

Type	BS34
Main jet:	127.5R
Needle jet:	Y-4
Jet needle:	US model 5C50-1
Other than US 5C48-3	
Jet needle clip position (Other than US):	2nd groove from top
Pilot jet:	37.5
Starter jet:	45
Main air jet:	85
Pilot air jet:	350
Pilot screw:	US model Non-adjustable
Other than US 2.0 turns out	
Service fuel level:	3 ± 1 mm
Float height:	18.6 mm

**KZ1000-J3/R2 Wiring Diagram**

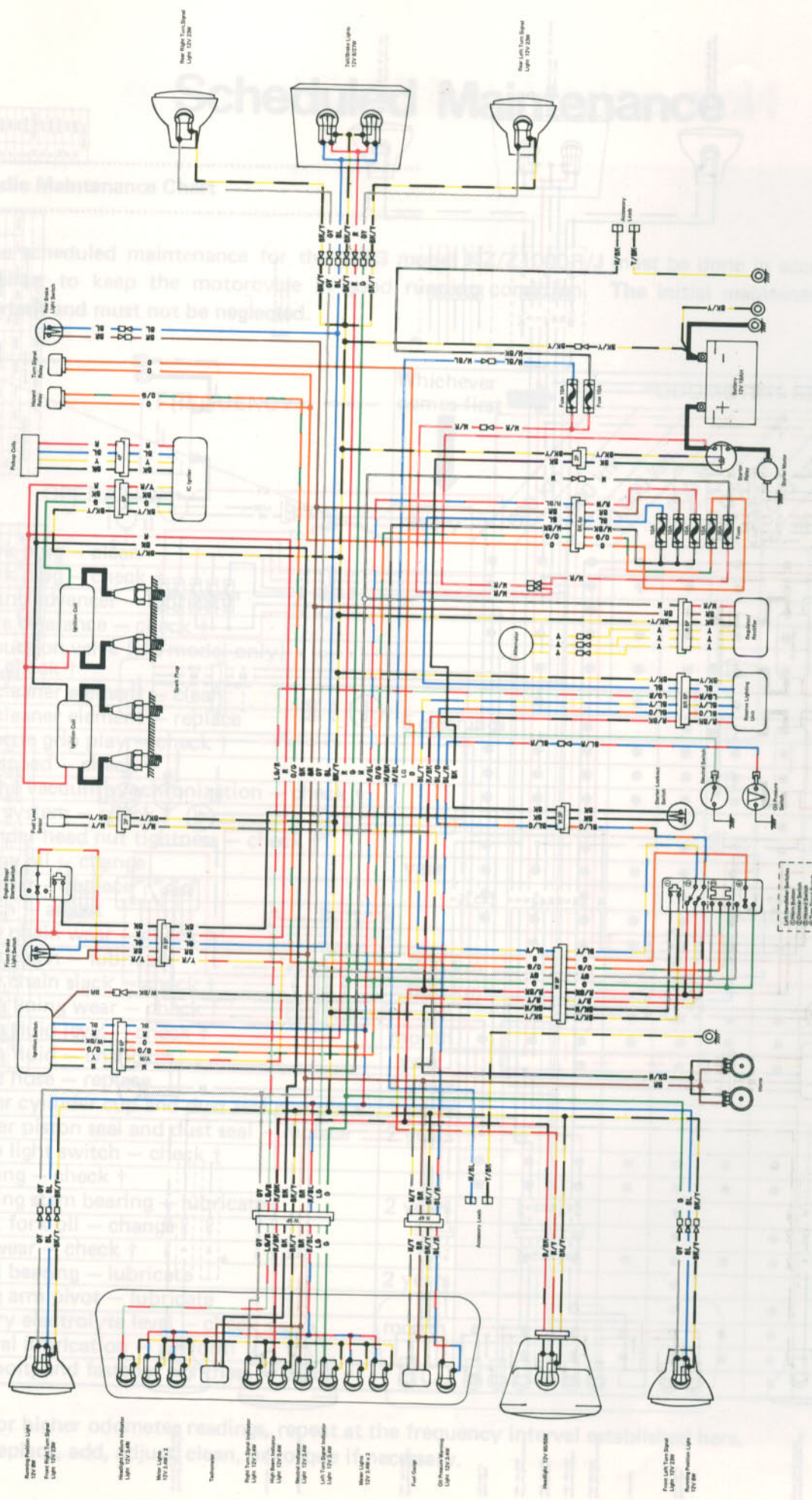

- Running Position Light  
12V 20W  
Front Right Turn Signal  
Light 12V 20W
- Headlight Status Indicator  
Light 12V 5.6W
- Mirror Light  
12V 2.0W x 2
- Taillight
- Right Turn Signal Indicator  
Light 12V 2.0W
- Left Turn Signal Indicator  
Light 12V 2.0W
- Left Turn Signal Indicator  
Light 12V 2.0W
- Left Turn Signal Indicator  
Light 12V 2.0W
- Headlight 12V 60/55W
- Front Left Turn Signal  
Light 12V 20W
- Running Position Light  
12V 20W

Color Code	Black	Blue	Green	Orange	Red	White	Yellow
BL	Black	Blue	Green	Orange	Red	White	Yellow

RIGHT HANDLEBAR SWITCH CONNECTIONS	
Color	Right Handlebar Switch
BL	OFF
BR	ON
BL/Y	OFF
BR/Y	ON

IGNITION SWITCH CONNECTIONS				
Color	Terminal 1	Terminal 2	Terminal 3	Terminal 4
BL	IGNITION	IGNITION	IGNITION	IGNITION
BR	IGNITION	IGNITION	IGNITION	IGNITION
BL/Y	IGNITION	IGNITION	IGNITION	IGNITION
BR/Y	IGNITION	IGNITION	IGNITION	IGNITION

LEFT HANDLEBAR SWITCH CONNECTIONS	
Color	Left Handlebar Switch
BL	OFF
BR	ON
BL/Y	OFF
BR/Y	ON

(11/78)

Z1000-J3/R2 Wiring Diagram

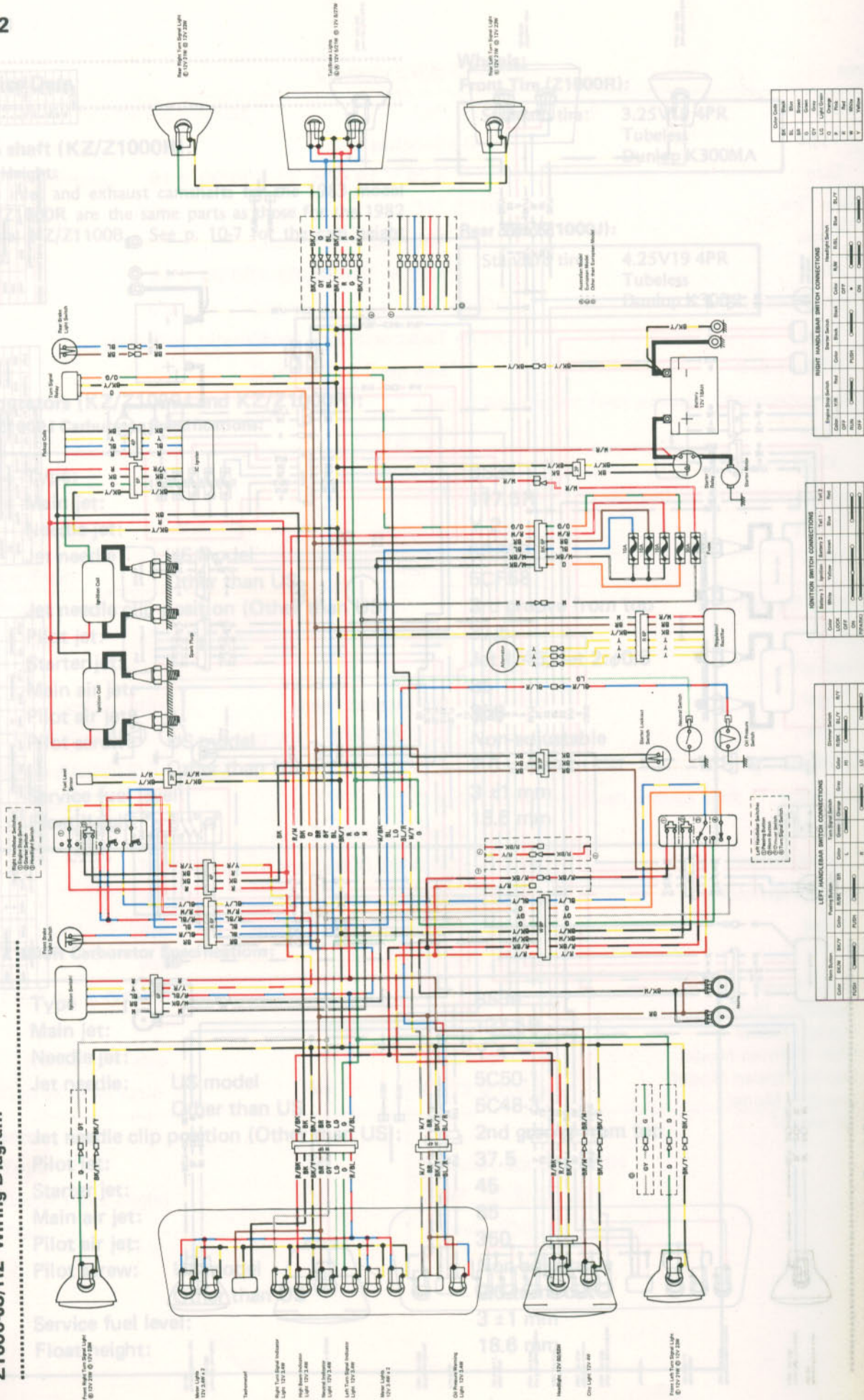

# Non-scheduled Maintenance

## Fuel Gauge (KZ/Z1000R/J)

The fuel gauge on the 1983 model KZ/Z1000R/J is of the bimetal type with a 7-volt voltage regulator built into it for over voltage protection, and the pointer returns to the left end when the ignition switch is turned off.

See pp. 5-31 through 5-33 for service information. The service data for the KZ1000M apply to the 1983 KZ/Z1000R/J.

## Speedometer (KZ/Z1000R/J) Odometer (KZ/Z1000R/J) Trip Meter (KZ/Z1000R/J)

The speedometer, odometer, and trip meter on the 1983 model KZ/Z1000R/J are mechanically driven through a flexible meter cable. Troubleshoot the meters using the same procedures as for an ordinary cable driven meter.

## Rear Shock Absorbers (KZ/Z1000R)

See p. 10-58, noting the following exception.

### Damping Force:

The damper adjuster on each rear shock absorber has 5 positions so that the damping force can be adjusted for different road and loading conditions. The numbers on the adjuster show the setting position of the damper.

The damping force can be left soft for average riding. But it should be adjusted harder for high speed riding, or riding with a passenger. If the damper setting feels too soft or too stiff, adjust it in accordance with the following table:

### Damping Force

Position	1	2	3	4	5
Damping Force	Larger $\longrightarrow$				

### Damping Force Adjustment

- Turn the adjuster to the desired number until you feel a click.
- Check to see that both adjuster are turned to the same relative position.

**WARNING**

- If both damper adjusters are not adjusted equally, handling may be impaired and a hazardous conditions may result.

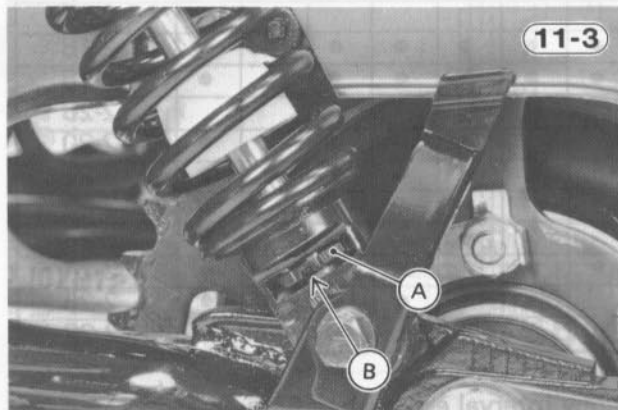

A. Damper Adjuster      B. Position Number

# Disassembly

## Carburetors (KZ/Z1000R/J)

### Removal and Installation

Refer to pp. 6-7 through 6-13, noting the following exception.

- Run the carburetor vent hoses between the air cleaner housing and the frame gusset, to the rear of the air cleaner housing.

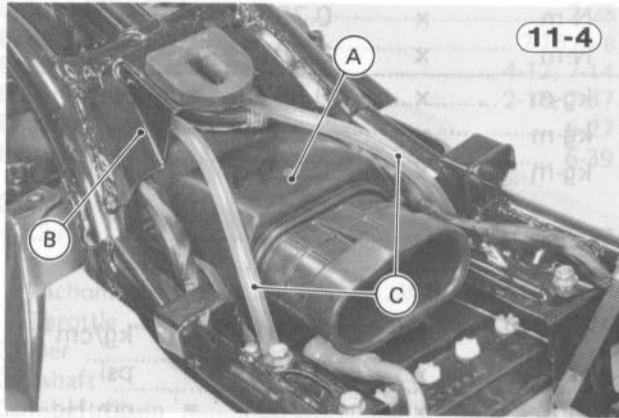

A. Air Cleaner Housing  
B. Gusset  
C. Vent Hoses

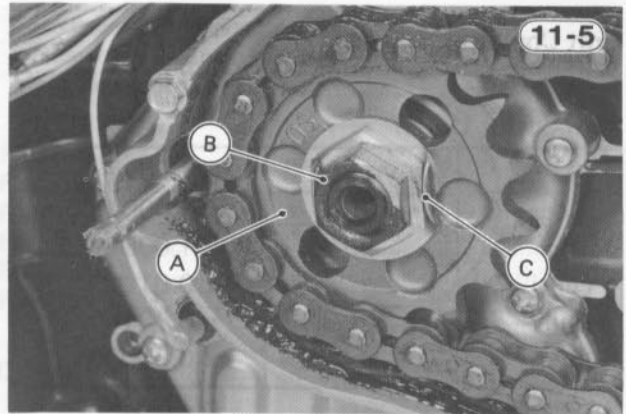

A. Engine sprocket: "OS" mark faces out.  
B. Nut: Tightening torque is 98 N-m (10.0 kg-m, 72 ft-lb).  
C. Splined washer: Bend one side of the washer over the side of the nut.

## Camshafts (KZ/Z1000R) Camshaft Sprockets (KZ/Z1000R)

### Removal and Installation

The inlet and exhaust camshafts and sprockets for the 1983 model KZ/Z1000R are the same as those for the 1982 model KZ/Z1100B. Refer to p. 10-52 for removal and installation instruction.

## Engine Sprocket (KZ/Z1000R/J)

### Removal and Installation

A nut holds the engine sprocket on the transmission output shaft and a splined washer is used to prevent the nut from loosening.

Item	Unit of Volume	Unit of Power	Unit of Temperature
Headlight Circuit			
Headlight Wiring			
Headlight Unit			
Horn			
Ignition Coil	0.2042 x		
Ignition Switch	0.2300 x		
Ignition Switch/Steering Assembly	0.8780 x		
Ignition Switch	0.8780 x		
Ignition Switch	2.113 x		
Ignition Switch	1.8485 x		
Ignition Switch	0.0381 x		
Ignition Switch	0.0381 x		
Ignition Switch	0.0810 x		
Neutral Switch			
Odometer			
Oil Cooler	1.380 x		
Oil Filter	1.341 x		
Oil Pan	0.1388 x		
Oil Pressure Switch	0.9883 x		
Oil Pump			
Pickup Coil Assembly			

# Appendix

## Unit Conversion Table

### Prefixes for Units:

Prefix	Symbol	Power
mega	M	x 1,000,000
kilo	k	x 1,000
centi	c	x 0.01
milli	m	x 0.001
micro	μ	x 0.000001

### Units of Mass:

kg	x	2.205	=	lb
g	x	0.03527	=	oz

### Units of Volume:

L	x	0.2642	=	gal (US)
L	x	0.2200	=	gal (imp)
L	x	1.057	=	qt (US)
L	x	0.8799	=	qt (imp)
L	x	2.113	=	pint (US)
L	x	1.816	=	pint (imp)
mL	x	0.03381	=	oz (US)
mL	x	0.02816	=	oz (imp)
mL	x	0.06102	=	cu in

### Units of Power:

kW	x	1.360	=	PS
kW	x	1.341	=	HP
PS	x	0.7355	=	kW
PS	x	0.9863	=	HP

### Units of Temperature:

$$\frac{9(^{\circ}\text{C} + 40)}{5} - 40 = ^{\circ}\text{F}$$

$$\frac{5(^{\circ}\text{F} + 40)}{9} - 40 = ^{\circ}\text{C}$$

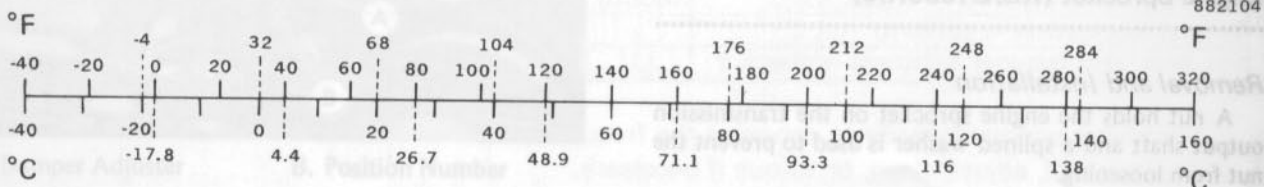

### Units of Length:

km	x	0.6214	=	mile
m	x	3.281	=	ft
mm	x	0.03937	=	in

### Units of Torque:

N-m	x	0.1020	=	kg-m
N-m	x	0.7376	=	ft-lb
N-m	x	8.851	=	in-lb
kg-m	x	9.807	=	N-m
kg-m	x	7.233	=	ft-lb
kg-m	x	86.80	=	in-lb

### Units of Pressure:

kPa	x	0.01020	=	kg/cm <sup>2</sup>
kPa	x	0.1450	=	psi
kPa	x	0.7501	=	cm Hg
kg/cm <sup>2</sup>	x	98.07	=	kPa
kg/cm <sup>2</sup>	x	14.22	=	psi
cm Hg	x	1.333	=	kPa

### Units of Speed:

km/h	x	0.6214	=	mph
------	---	--------	---	-----

### Units of Force:

N	x	0.1020	=	kg
N	x	0.2248	=	lb
kg	x	9.807	=	N
kg	x	2.205	=	lb

# Index

- Additional Considerations for Racing ..... 8-2  
 Air Cleaner ..... 2-9, 6-7, 9-15  
 Air Cleaner Housing ..... 6-7  
 Air Suction Valve ..... 2-9, 3-13, 6-15  
 Alternator ..... 5-5, 6-31  
 Alternator Rotor ..... 6-31  
 Automatic Turn Signal Canceling System ..... 5-24
- Battery ..... 2-24, 5-2, 7-25  
 Battery Housing ..... 7-25  
 Before Servicing ..... 1-2  
 Bolt and Nut Tightening ..... 2-28  
 Brake ..... 2-15, 4-8  
 Brake Hose ..... 4-12, 7-14  
 Brake Light Switch ..... 2-18, 7-37  
 Breather Cover ..... 6-27  
 Bypass Valve ..... 6-39
- Cable  
 Clutch ..... 7-22  
 Speedometer ..... 7-24  
 Tachometer ..... 7-25  
 Throttle ..... 7-24
- Caliper ..... 4-10, 7-16  
 Camshaft ..... 3-5, 6-17  
 Camshaft Chain ..... 3-6, 6-49  
 Camshaft Chain Guide ..... 3-6, 6-15, 6-24  
 Camshaft Sprocket ..... 6-17  
 Carburetor ..... 2-10, 3-2, 6-7, 8-2
- Chain  
 Camshaft ..... 3-6, 6-49  
 Drive ..... 2-13, 4-18, 7-46
- Chain Tensioner ..... 3-6, 6-17  
 Charging System ..... 5-4  
 Clutch ..... 2-12, 3-20, 6-37  
 Clutch Cable ..... 7-22  
 Clutch Release ..... 6-28  
 Connecting Rod ..... 3-18  
 Crankcase Split ..... 6-44, 6-49  
 Crankshaft ..... 3-18, 6-49  
 Cylinder Block ..... 3-14, 6-24  
 Cylinder Head ..... 3-7, 6-17  
 Cylinder Head Cover ..... 6-15
- Disc ..... 4-12, 7-14  
 Drive Chain ..... 2-13, 4-18, 7-46
- Electric Odometer ..... 5-33, 7-31  
 Electric Speedometer ..... 5-33, 7-31  
 Electric Starter System ..... 5-15  
 Electric Tachometer ..... 5-33, 7-31  
 Engine Lubrication System ..... 3-25  
 Engine Oil ..... 2-4, 9-15  
 Engine Removal ..... 6-42  
 Engine Sprocket ..... 4-8, 6-28  
 Engine Sprocket Cover ..... 6-28  
 External Shift Mechanism ..... 6-28
- Flow Chart  
 Disassembly—Chassis ..... 7-2
- Disassembly—Engine Installed ..... 6-2  
 Disassembly—Engine Removed ..... 6-4  
 Engine Removal ..... 6-3
- Front Fork ..... 2-20, 4-13, 7-42, 9-34  
 Fuel Gauge ..... 5-31, 7-31, 9-19  
 Fuel Level Sender ..... 6-5  
 Fuel System (KZ/Z1000-J, K, M) ..... 2-24  
 Fuel Tank ..... 3-2, 6-5, 9-35  
 Fuel Tap ..... 3-2, 6-5
- General Lubrication ..... 2-25
- Handlebar ..... 7-39  
 Handlebar Switch Housing ..... 7-38  
 Hazard Warning Circuit ..... 5-24  
 Headlight ..... 5-20  
 Headlight Bracket ..... 7-27  
 Headlight Circuit ..... 5-21  
 Headlight Housing ..... 7-27  
 Headlight Unit ..... 7-27  
 Horn ..... 5-30
- Ignition Coil ..... 6-13  
 Ignition Switch ..... 5-19, 7-37  
 Ignition Switch/Steering Lock Assembly ..... 7-37  
 Ignition System ..... 2-5, 5-8  
 Ignitor ..... 7-25
- Kawasaki Clean Air System ..... 3-13
- Master Cylinder ..... 4-9, 7-18  
 Model Identification ..... 1-3, 9-4  
 Muffler ..... 6-14
- Neutral Switch ..... 6-28
- Odometer ..... 5-33, 7-31, 9-19  
 Oil Cooler ..... 9-33  
 Oil Filter ..... 2-4, 6-39  
 Oil Pan ..... 6-39  
 Oil Pressure Relief Valve ..... 9-34  
 Oil Pressure Switch ..... 6-27  
 Oil Pump ..... 6-39
- Pad ..... 7-14  
 Periodic Maintenance Chart ..... 2-2, 9-14  
 Pickup Coil Assembly ..... 6-36  
 Piston ..... 3-14, 6-24  
 Piston Ring ..... 6-24
- Rear Shock Absorber ..... 4-15, 7-46  
 Rear Wheel Coupling ..... 7-7  
 Regulator/Rectifier ..... 5-5, 7-25  
 Reserve Lighting System ..... 5-21  
 Relief Valve ..... 9-34  
 Reserve Lighting Device ..... 7-25  
 Right Engine Cover ..... 6-36  
 Rim ..... 2-23, 4-6, 7-11





## MODEL APPLICATION

Year	Model	Beginning Frame No.
1981	KZ1000-J1 (US and Canadian Models)	JKAKZCJ1*BA000001
	Z1000-J1 (Other than US and Canadian Models)	KZT00J-000001
	KZ1000-K1 (US and Canadian Models)	JKAKZCK1*BA000001
	Z1000-K1 (Other than US and Canadian Models)	KZT00K-000001
	KZ1000-M1 (US and Canadian Models)	JKAKZCM1*BA000001
	KZ1100-B1 (US and Canadian Models)	JKAKZBB1*BA000001
	Z1100-B1 (Other than US and Canadian Models)	KZT10B-000001

1982	KZ1000-J2 (US and Canadian Models)	JKAKZCJ1*CA007901
	Z1000-J2 (Other than US and Canadian Models)	KZT00J-007901
	KZ1000-K2 (US and Canadian Models)	JKAJZCK1*CA006901
	Z1000-K2 (Other than US and Canadian Models)	KZT00K-006901
	KZ1000-M2 (US and Canadian Models)	JKAKZCM1*CA004701 or JKAKZCM1*CB500001
	KZ1100-B2 (US and Canadian Models)	JKAKZBB1*CA010401
	Z1100-B2 (Other than US and Canadian Models)	KZT10B-010401

1982	KZ1000-R1 (US and Canadian Models)	JKAKZCR1*CA-000001
	Z1000-R1 (Other than US and Canadian Models)	KZTOOR-000001

1983	Z1000-J3 (Other than US and Canadian Models)	KZTOOJ-017501
	KZ1000-R2 (US and Canadian Models)	JKAKZCR1*DA-001101
	Z1000-R2 (Other than US and Canadian Models)	KZTOOR-001101

\*This digit in the frame number changes from one machine to another.

**KAWASAKI**  
HEAVY INDUSTRIES, LTD.  
CONSUMER PRODUCTS & COMPONENTS GROUP

Part No. 99924-1026-03

Printed in Japan